

User Manual

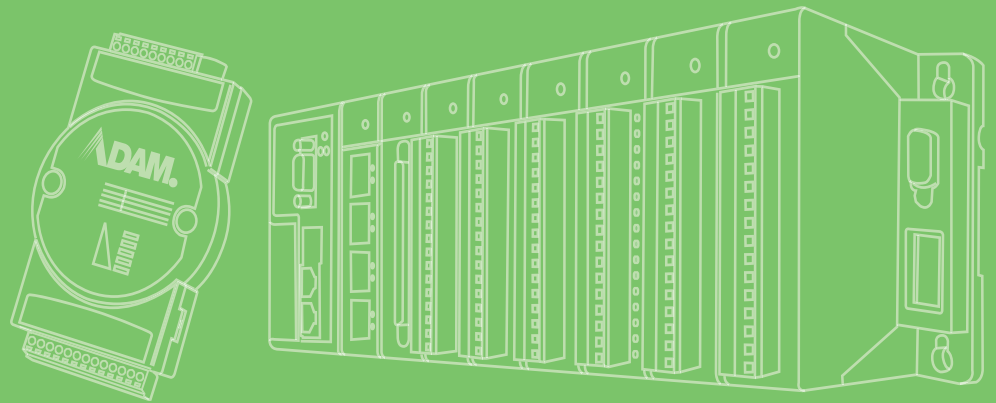

ADAM-3600-C2G

iRTU User's Manual

ADVANTECH

Enabling an Intelligent Planet

Copyright

The documentation and the software included with this product are copyrighted 2015 by Advantech Co., Ltd. All rights are reserved. Advantech Co., Ltd. reserves the right to make improvements in the products described in this manual at any time without notice. No part of this manual may be reproduced, copied, translated or transmitted in any form or by any means without the prior written permission of Advantech Co., Ltd. Information provided in this manual is intended to be accurate and reliable. However, Advantech Co., Ltd. assumes no responsibility for its use, nor for any infringements of the rights of third parties, which may result from its use.

Acknowledgements

ADAM is a trademark of Advantech Co., Ltd.

IBM and PC are trademarks of International Business Machines Corporation.

All other product names or trademarks are properties of their respective owners.

Product Warranty (2 years)

Advantech warrants to you, the original purchaser, that each of its products will be free from defects in materials and workmanship for two years from the date of purchase.

This warranty does not apply to any products which have been repaired or altered by persons other than repair personnel authorized by Advantech, or which have been subject to misuse, abuse, accident or improper installation. Advantech assumes no liability under the terms of this warranty as a consequence of such events.

Because of Advantech's high quality-control standards and rigorous testing, most of our customers never need to use our repair service. If an Advantech product is defective, it will be repaired or replaced at no charge during the warranty period. For out-of-warranty repairs, you will be billed according to the cost of replacement materials, service time and freight. Please consult your dealer for more details.

If you think you have a defective product, follow these steps:

1. Collect all the information about the problem encountered. (For example, CPU speed, Advantech products used, other hardware and software used, etc.) Note anything abnormal and list any onscreen messages you get when the problem occurs.
2. Call your dealer and describe the problem. Please have your manual, product, and any helpful information readily available.
3. If your product is diagnosed as defective, obtain an RMA (return merchandise authorization) number from your dealer. This allows us to process your return more quickly.
4. Carefully pack the defective product, a fully-completed Repair and Replacement Order Card and a photocopy proof of purchase date (such as your sales receipt) in a shippable container. A product returned without proof of the purchase date is not eligible for warranty service.
5. Write the RMA number visibly on the outside of the package and ship it prepaid to your dealer.

Part No. XXXXXXXXXXXX

Printed in Taiwan

Edition 1

December 2015

Declaration of Conformity

CE

The ADAM-4000 series developed by Advantech Co., Ltd. has passed the CE test for environmental specifications when operated within an industrial enclosure (ADAM-4950-ENC). Therefore, in order to protect the ADAM modules from being damaged by ESD (Electric Static Discharge), we strongly recommend that the use of CE-compliant industrial enclosure products when using any ADAM module.

Technical Support and Assistance

1. Visit the Advantech web site at www.advantech.com/support where you can find the latest information about the product.
2. Contact your distributor, sales representative, or Advantech's customer service center for technical support if you need additional assistance. Please have the following information ready before you call:
 - Product name and serial number
 - Description of your peripheral attachments
 - Description of your software (operating system, version, application software, etc.)
 - A complete description of the problem
 - The exact wording of any error messages

Contents

Chapter 1	Introduction.....	1
1.1	Product Concept &Target Market.....	2
	Figure 1.1 iRTU Application Architecture.....	2
Chapter 2	Specifications	3
2.1	Product Key Features	4
2.2	ADAM-3600-C2G Specification.....	5
	2.2.1 ADAM-3600-C2G Specification of Main Unit	5
	2.2.2 Expansion Module Specifications	7
2.3	LED Indicators.....	8
	Figure 2.1 LED Indicator.....	8
	2.3.1 System LED	9
	2.3.2 Digital Input/Output Indicator LED	9
	2.3.3 Serial Communication LED	9
	2.3.4 Ethernet LED	9
2.4	iRTU Dimensions	10
	Figure 2.2 ADAM-3600 Dimensions	10
Chapter 3	Wiring and Installation	11
3.1	Wiring.....	12
	3.1.1 Power Supply Wiring.....	12
	Figure 3.1 Power Supply Wiring	12
	3.1.2 3-1-2..... Input / Output Wiring.....	12
	Figure 3.2 Analog Input Wiring	12
	Figure 3.3 Digital Input Wiring	13
	Figure 3.4 Digital Output Wiring.....	13
	3.1.3 Serial Port Wiring	13
	Figure 3.5 Serial Port Wiring.....	13
3.2	Installation	14
	3.2.1 Wall-mounted and DIN-Rail Installation	14
	Figure 3.6 Wall-mounted Installation	14
	Figure 3.7 DIN-Rail Installation.....	14
	3.2.2 Wireless Module Installation	15
	Figure 3.8 Wireless Module Installation.....	15
	3.2.3 Expansion Input/Output Module Installation	15
	Figure 3.9 Expansion Input/Output Module Installation	15
	Figure 3.10Expansion Input/Output Module Installation	15
	3.2.4 Writeable Label	16
	Figure 3.11Writeable Label.....	16
	3.2.5 SD Card Installation	16
	Figure 3.12Card Installation.....	16
	3.2.6 SIM Card Installation.....	17
	Figure 3.13SIM Card Installation	17
3.3	Jumper/Switch Settings.....	18
	3.3.1 DIP Switch Settings	18
	Figure 3.14DIP Switch Setting.....	18
	3.3.2 Jumper Settings	19
	Figure 3.15Jumper Settings.....	19

Chapter 4 Advantech iRTU Studio 21

4.1	iRTU Studio Introduction.....	22
4.2	Using iRTU Studio for Configuration and Management.....	22
4.2.1	Project Initialization.....	22
	Figure 4.1 Creating a new project	22
	Figure 4.2 Adding Devices and Editing	23
	Figure 4.3 Copying Devices	23
	Figure 4.4 Deleting Devices	24
4.2.2	Configuring the Data Center and Link Tag with I/O.....	24
	Figure 4.5 Configuring Onboard I/O Analog.....	25
	Figure 4.6 DI interfaces counter function configuration.....	25
	Figure 4.7 DO interface PWM function configuration.....	26
	Figure 4.8 Adding COM port.....	27
	Figure 4.9 Adding a COM meter.....	27
	Figure 4.10Editing TCP Information	28
	Figure 4.11Adding and Deleting a TCP Meter.....	28
	Figure 4.12Configuring a TCP Meters I/O	29
	Figure 4.13Adding and Editing TCP Ports.....	29
	Figure 4.14Adding a New ZigBee Port.....	30
	Figure 4.15Adding a ZigBee Meter.....	31
	Figure 4.16ZigBee Meter I/O Configuration.....	31
	Figure 4.17Adding the acquisition tag	32
	Figure 4.18 Adding the computation tag.....	32
	Figure 4.19User Tag Configuration	33
4.2.3	Data Logger Configuration.....	34
	Figure 4.20Historical recording data configuration	34
4.2.4	Protocol Service Configuration	34
	Figure 4.21Adding I/O Tags to the Modbus Address List.....	35
	Figure 4.22Adding I/O Tag Information	35
	Figure 4.23WebAccess whereIAM	36
4.2.5	Connectivity Configuration.....	36
	Figure 4.24Relationship among connection period, connection duration and idle time	37
	Figure 4.25DTU-Four faith PROT protocol in active connection	37
	Figure 4.26Webaccess WhereIAM Protocol in active connection	38
4.2.6	System Settings.....	38
	Figure 4.27On-board I/O Settings	39
	Figure 4.28Expansion I/O Settings.....	39
	Figure 4.29Wired Network Settings.....	40
	Figure 4.30Wireless Network Settings	40
	Figure 4.31GPRS Settings	41
	Figure 4.32GPRS Script Setting.....	41
	Figure 4.33LED configuration.....	41
4.3	Project Deployment.....	42
4.3.1	Device Identification.....	43
	Figure 4.34Identification for Connected RTU Devices	43
4.3.2	Project Download.....	43
	Figure 4.35Project Download	43
4.3.3	Password Settings.....	44
	Figure 4.36Password Information.....	44
	Figure 4.37Password Settings.....	44

Appendix A ADAM-3600 Naming Rules 45

A.1	ADAM-3600 Naming Rules.....	46
	Figure A.1 ADAM-3600 Naming Rules	46

Appendix B **Interface Definition47**

B.1	Interface Definitions	48
	B.1.1 Communication Ports.....	48
	B.1.2 I/O Interface Definition	50

Chapter 1

Introduction

1.1 Product Concept & Target Market

The ADAM-3600-C2G is an Intelligent Remote Terminal Unit / iRTU, mainly for the oil & gas and water industries. Intelligent network nodes in IoT can control the downstream field devices to complete delivery tasks, transfer data to upstream devices wired or wirelessly. It is a key to connecting devices to the Internet of things architecture.

In the remote and wide ranging oil, gas and water application site maintenance and updating equipment is extremely costly. Intelligent RTU can perform remote monitoring, operation, maintenance and updates via the Internet. iRTU can perform up-date, complete delivery tasks at the site, and update data to the cloud. iRTU can also communicate with each other, quickly handle I/O correlation on emergencies to reduce the loss

The ADAM-3600 has a high performance and low power processor, adopts 20 local I/O points and wired and wireless communication modes, users can collect, process and distribute the local information. It has a built-in real-time operating system and a real-time database, providing customers with an open interface and supports diverse programming languages.

System Architecture

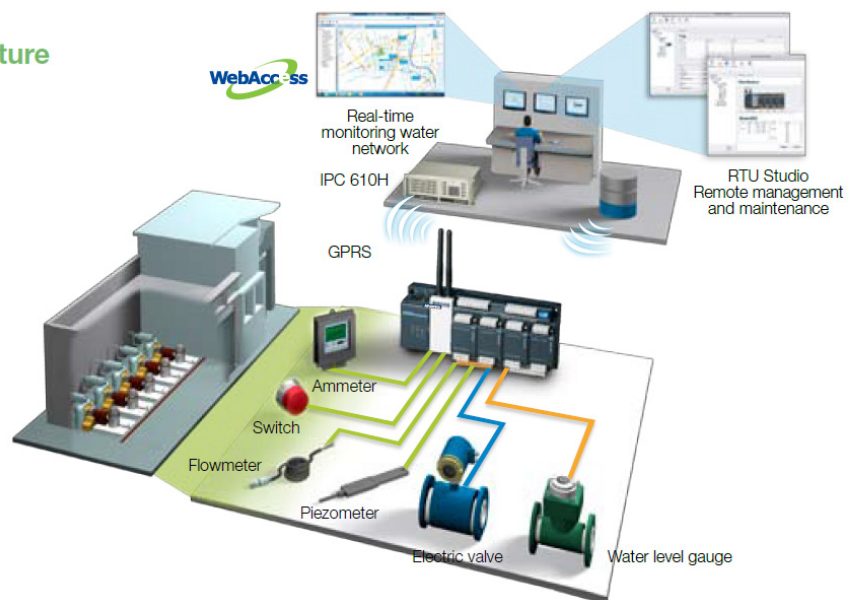

Figure 1.1 iRTU Application Architecture

Chapter 2

Specifications

2.1 Product Key Features

Wireless communication for high-efficient transmission

An RTU is usually applied to a wide range of monitoring, such as oil field or oil pipelines. In wide area environments, wired communication often has cost and maintenance problems. The ADAM-3600-C2G series two built-in Mini-PCIe cards slots and can support two types of different wireless communication interfaces. The supported wireless communication functions include: GPRS, 3G, Wi-Fi and Zigbee, users have many choices in the application of wireless communication, and are not restricted by field conditions.

High performance low-power CPU/RAM

The ADAM-3600-C2G comes with a 32-bit Cortex A8 600MHz CPU and DDR3 memory chips, which greatly improves the processing speed and efficiency. Based on these advantages and its unique low-power design, customers could take their time to tackle complex logic programs.

Wide range of operating temperature with durability in harsh environment and reducing maintenance costs

It can be used for outdoor control cabinets and therefore must be able to withstand the heat of summer and the cold of winter. The ADAM-3600 supports an operating temperature range of - 40°C ~ 70°C. The selected components are industrial grade, and have been tested with the strictest environmental control, to ensure that the products have a long life and, stable working in harsh environments.

Convenient remote project configuration software iRTU Studio

Provides project configuration software with remote operation. Users can configure all the devices in an offline and group mode, and can automatically conduct remote downloading based on its own code. Users can use this software for remote monitoring, updating the programmable logic and firmware, to save the cost of manpower and materials.

Supports open communication protocols

In addition to the standard Modbus communication protocol, it also supports the object DNP3 protocol. DNP3 is an international standard for RTU applications, and can also realize data identification, breakpoint transmission, initiative report and other functions under this protocol user can quickly integrate most of the SCADA system.

Multiple programming interfaces

Adopts an open real-time Linux system architecture, and run the real-time database. Transmission gives priority to the customizable tag. Data with a simple configuration can be converted instantly within the different communication protocols. And provides the IEC - 61131-3 standard & C/C++ library for the customer to develop programs. This lets users develop programmable logic control in the most convenient way.

NodeID as identification facilitate remote batch configuration

ADAM-3600 has a six bit DIP-switch on board which can be identification for 64 devices on the field. Through an ordinary cable, it could download configuration documents into RTU devices (with a maximum of 64), and customers could find out the sources of faults through ID codes when variations encountered in the performance of RTU.

Intelligent communication condition monitoring software iCDManager

Communication is the key function of RTU applications. RTU hardware can monitor the health status of the hardware communication. Users can use the intelligent algorithm to identify the health status of communications lines, remotely monitor the communication quality through the network in group mode, conduct the maintenance in advance, so as to avoid emergency repair caused by temporary failure.

2.2 ADAM-3600-C2G Specification

2.2.1 ADAM-3600-C2G Specification of Main Unit

2.2.1.1 System Specifications

CPU	A8 AM3352BZCZD60	
RAM	DDR3 256MB	
Battery Backup RAM	32KB	
Power Requirement	9-36V _{DC}	
Digital Input/ Pulse In	8-ch	
Digital Output/ Pulse Output	4-ch	
Analogue Input	8-ch	
Extension I/O Slot	4-Slot	
Serial Port	2 x RS-485	
	1 x RS-232/485(DB9)	
Wireless	Interface	2 x Mini-PCle (1x Half-Size/ 1 x Full-Size)
	Zigbee	Serial Signal
	GPRS/3G/ Wi-Fi	USB Signal
USB	1 x USB2.0	
Ethernet	2 x RJ-45	
Display	1 x VGA	
LEDs	DI/DO/System/Serial Port/LAN	
SD Card	Standard SD (For Data Storage)	
	Micro SD(1GB For OS Storage)	
Operating Temperature	-40~70°C	
Storage Temperature	-40~85°C	

2.2.1.2 Input / Output Specification

Analog Input	
Channel	8, differential
Input Type	Voltage, Current
Voltage/Current Range	$\pm 10V$, $\pm 2.5V$, 0~20mA, 4~20 mA
Resolution	16-bit
Sampling rate	10 samples/second (total)
Input Impedance	10M Ω
Accuracy	$\pm 0.1\%$ or better (Full Scale)
CMR @ 50/60 Hz	120 dB
NMR @ 50/60 Hz	100 dB
Span Drift	± 25 ppm/ $^{\circ}C$
Zero Drift	± 3 μV / $^{\circ}C$, ± 3 μA / $^{\circ}C$
Isolation Voltage	2,000V _{DC}
Burn-out detection	Yes (Current-only)

Digital Input/Pulse Input	
Channel	8
Input Type	Sink (Wet Contact)/ Counter
Wet Contact Input	Logic0: 0 ~ 5 V _{DC} Logic 1: 11~30V _{DC}
Rated Voltage	12/24VDC
Rated Input Current	>5mA@12V _{DC} >10mA@24V _{DC}
Input Filter	Programmable, Default: 3ms
Pulse Input Frequency	150HZ
Over Voltage Protection	+40V _{DC}
Isolation Voltage	2000V _{DC}

Digital Output/Pulse Output		
Channel	4	
Output Type	Open Collector (Sink)	
OC Output	Rated Voltage	8~30 V _{DC}
	Rated Current	200mA(max.load)
Over Voltage Protection	+40V _{DC}	
Pulse Output Frequency	1KHz	
Isolation Voltage	2000V _{DC}	

2.2.1.3 Environmental Specifications

- Operating Temperature: -40~70°C
- Storage Temperature: -40~85°C
- Operating Humidity: 20~95% (non-condensing)
- Storage Humidity: 0 ~ 95% (non-condensing)

2.2.2 Expansion Module Specifications

ADAM-3600-C2G support four slots expansion can support different type I/O modules in one integrated unit.

2.2.2.1 ADAM-3617 (4-ch AI)

Channel	4, differential
Input Type	Voltage, Current
Voltage/Current Range	$\pm 10V$, $\pm 2.5V$, $0\sim 20mA$, $4\sim 20 mA$
Resolution	16-bit
Sampling rate	10 samples/second (total)
Input Impedance	$10M\Omega$
Accuracy	$\pm 0.1\%$ or better (Full Scale)
CMR @ 50/60 Hz	120 dB
NMR @ 50/60 Hz	100 dB
Span Drift	$\pm 25 ppm/^{\circ}C$
Zero Drift	$\pm 3 \mu V/^{\circ}C$, $\pm 3 \mu A/^{\circ}C$
Isolation Voltage	$2000V_{DC}$
Burn-out detection	Yes (Current-only)

2.2.2.2 ADAM-3618 (3-ch Thermocouple)

Channel	3 , differential
Input Type	J,K,T,E,R,S,B Type Thermocouple
Resolution	16-bit
Sampling rate	10 samples/second (total)
Input Impedance	$2M\Omega$
Accuracy	$\pm 0.1\%$ or better (Full Scale)
CMR @ 50/60 Hz	90dBs
NMR @ 50/60 Hz	60dBs
Span Drift	$\pm 25 ppm/^{\circ}C$
Zero Drift	$\pm 3 \mu V/^{\circ}C$
Isolation Voltage	$2000 V_{DC}$
Burn-out detection	Yes (Current-only)

2.2.2.3 ADAM-3622 (2-ch AO)

Channel	2
Output Type	Voltage, Current
Output Range	$0 \sim 10 VDC$, $0\sim 20 mA$, $4\sim 20 mA$
Resolution	12-bit
Accuary	$\pm 0.1\%$ or better (Full Scale)
Current Load Resistor	$0 \sim 500$
Span Drift	$\pm 25 ppm/^{\circ}C$
Zero Drift	$\pm 3 \mu V/^{\circ}C$
Isolation Voltage	$2000 V_{DC}$
Burn-out detection	Yes (Current-only)

2.2.2.4 ADAM-3651 (8-ch DI/ PI)

Channel	8
Input Type	Sink (Wet Contact)/ Counter
Wet Contact Input	Logic0: 0 ~ 5 V _{DC} Logic 1: 11~30V _{DC}
Rated Voltage	12/24 V _{DC}
Rated Input Current	>5mA@12V _{DC} >10mA@24V _{DC}
Input Filter	Programmable, Default: 3ms
Pulse Input Frequency	150HZ
Over Voltage Protection	+40 V _{DC}

2.2.2.5 ADAM-3656 (8-ch DO/ PO)

Channel	8	
Output Type	Open Collector (Sink)	
OC Output	Rated Voltage	8~30 V _{DC}
	Rated Current	200 mA(max.load)
Over Voltage Protection	+40 V _{DC}	
Pulse Output Frequency	1KHz	
Isolation Voltage	2000 V _{DC}	

2.2.2.6 ADAM-3664 (4-ch RO)

Channel	4	
Output Type	Open Collector (Sink)	
OC Output	Rated Voltage	8~30 V _{DC}
	Rated Current	200mA(max.load)
Over Voltage Protection	+40 V _{DC}	
Pulse Output Frequency	1KHz	
Isolation Voltage	2000 V _{DC}	

2.3 LED Indicators

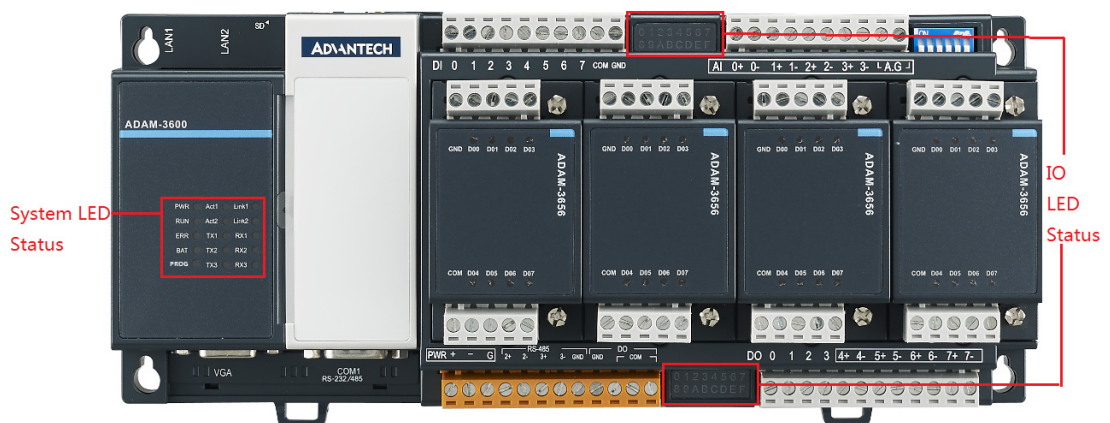

Figure 2.1 LED Indicator

2.3.1 System LED

LED	Color	Function Description
PWR	Green	Device powered indicator. Extended function is described in 4-2-6-4.
RUN	Green	Control logic running indicator. Extended function is described in 4-2-6-4.
ERR	Red	Control logic error indicator. Extended function is described in 4-2-6-4.
BAT	Red	Light on, battery lower than 5V
PROG	Green	Control by user's program

2.3.2 Digital Input/Output Indicator LED

LED	Color	Function Description
DI0	Green	Light on, the channel is activated by input signal
DI1	Green	
DI2	Green	
DI3	Green	
DI4	Green	
DI5	Green	
DI6	Green	
DI7	Green	
DO0	Green	Light on, the channel output is activated
DO1	Green	
DO2	Green	
DO3	Green	

2.3.3 Serial Communication LED

LED	Color	Function Description
TX1	Orange	Blinking, COM1 is sending data
RX1	Green	Blinking, COM1 is receiving data
TX2	Orange	Blinking, COM2 is sending data
RX2	Green	Blinking, COM2 is receiving data
TX3	Orange	Blinking, COM3 is sending data
RX3	Green	Blinking, COM3 is receiving data

2.3.4 Ethernet LED

LED	Color	Function Description
Link1	Orange	Light on, LAN1 is connected with Ethernet
Act1	Green	Blinking, LAN1 is sending data to Ethernet
Link2	Orange	Light on, LAN2 is connected with Ethernet
Act2	Green	Blinking, LAN2 is sending data to Ethernet

2.4 iRTU Dimensions

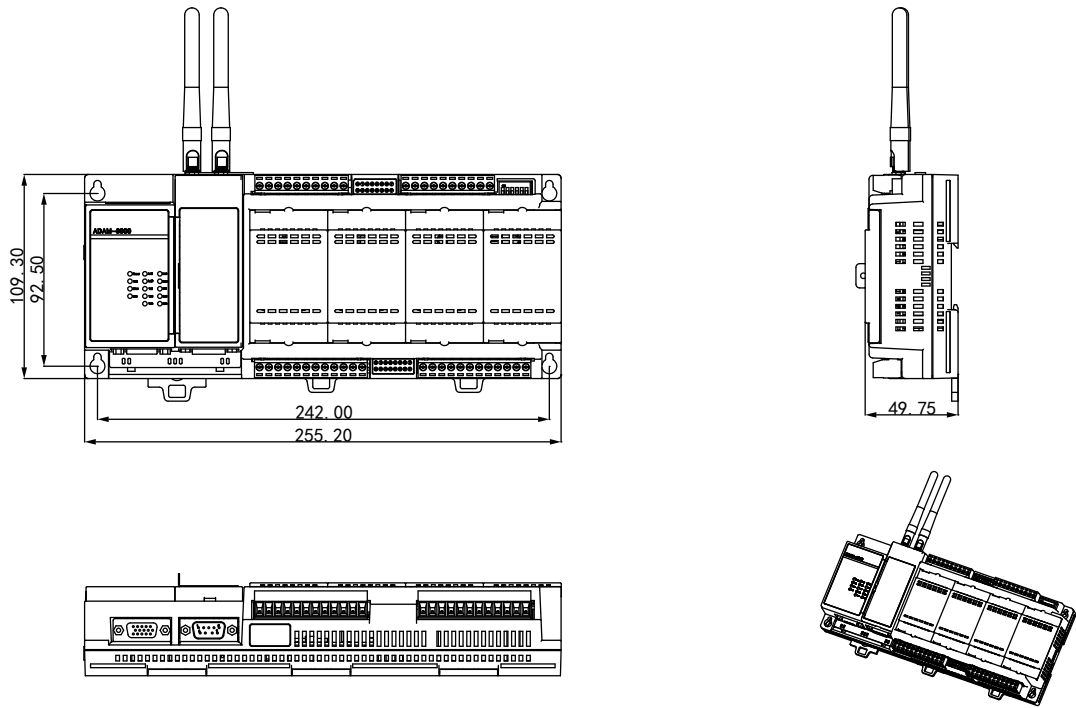

Figure 2.2 ADAM-3600 Dimensions

Chapter 3

Wiring and Installation

3.1 Wiring

3.1.1 Power Supply Wiring

ADAM-3600-C2G supports mains input ranging from 10 V_{DC} to 30 V_{DC}. Users can choose standard 12 V_{DC} or 24 V_{DC} power supply.

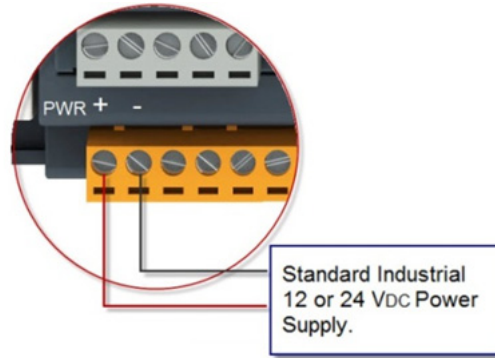

Figure 3.1 Power Supply Wiring

3.1.2 3-1-2 Input / Output Wiring

3.1.2.1 Analog Input Wiring

ADAM-3600-C2G equips with 8 channels AI with differential wiring type, wire as shown below:

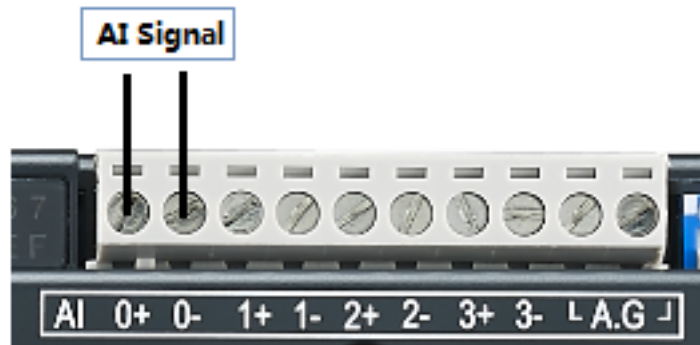

Figure 3.2 Analog Input Wiring

3.1.2.2 Digital Input Wiring

The ADAM-3600-C2G is equipped with 8 channels DI, follow the below diagram for wiring. The pin “COM” is for positive voltage wiring and provides a pull high voltage to the unwired pins. Normally user can leave it empty, and consider wiring while the field interference is significant.

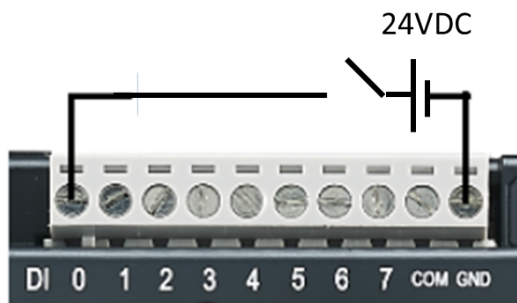

Figure 3.3 Digital Input Wiring

3.1.2.3 Digital Output Wiring

ADAM-3600-C2G is equipped with 4 channels DO, follow the below diagram for wiring



Figure 3.4 Digital Output Wiring

3.1.3 Serial Port Wiring

ADAM-3600-C2G is equipped with 3 serial ports, the COM2/3 are for RS-485 and locate on the orange terminal, please follow the below diagram for wiring:

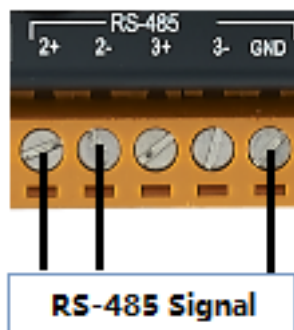

Figure 3.5 Serial Port Wiring

3.2 Installation

3.2.1 Wall-mounted and DIN-Rail Installation

The ADAM-3600-C2G supports two types of installation: Wall-mounted and DIN-Rail Installation.

For wall-mounted installation, users can fix the device on the wall with 4 screws as shown below.

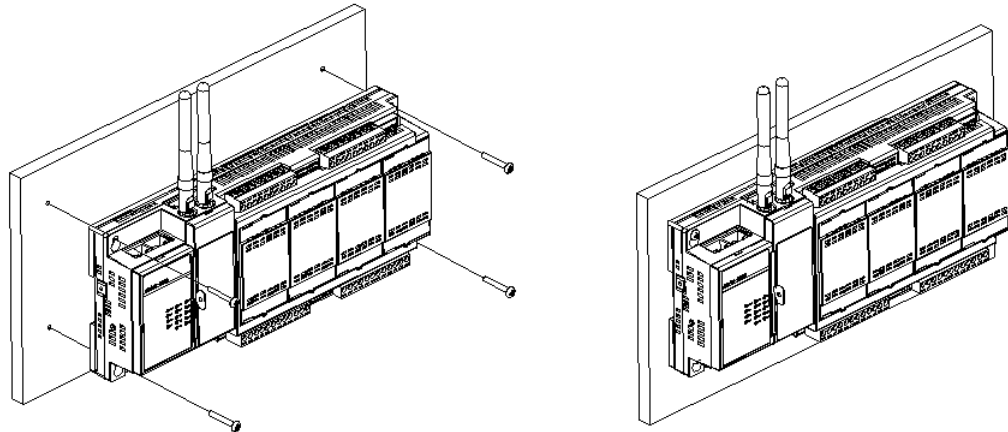

Figure 3.6 Wall-mounted Installation

For DIN-Rail installation, follow the below diagram to put the device on the DIN-Rail, and lock the 3 lock to fix the device on the DIN-Rail

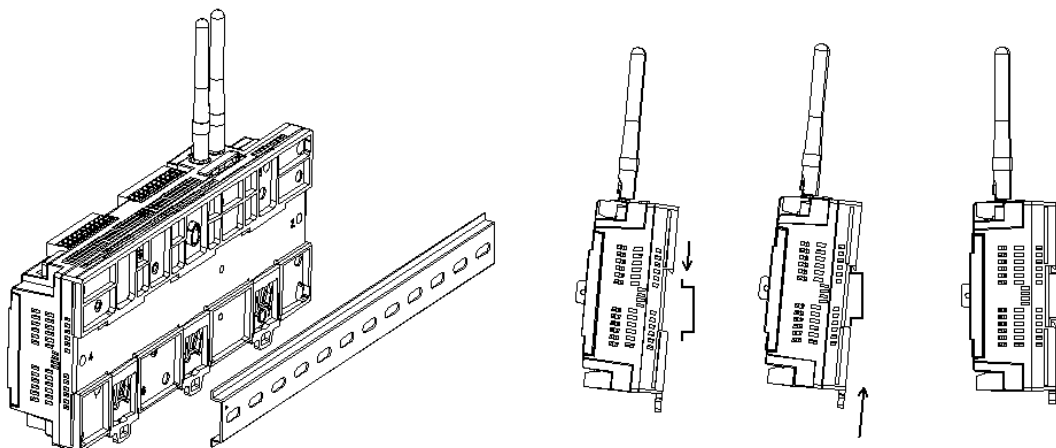

Figure 3.7 DIN-Rail Installation

3.2.2 Wireless Module Installation

There are two wireless expansion interfaces under the gray cover, which supports two Mini-PCle ports, and can insert wireless LAN card. Two overlapping network cards can be installed. The below supports half-sized card while the upper supports full-size card. Two screws are needed to install each card, and then the antenna could be installed. More details as follows:

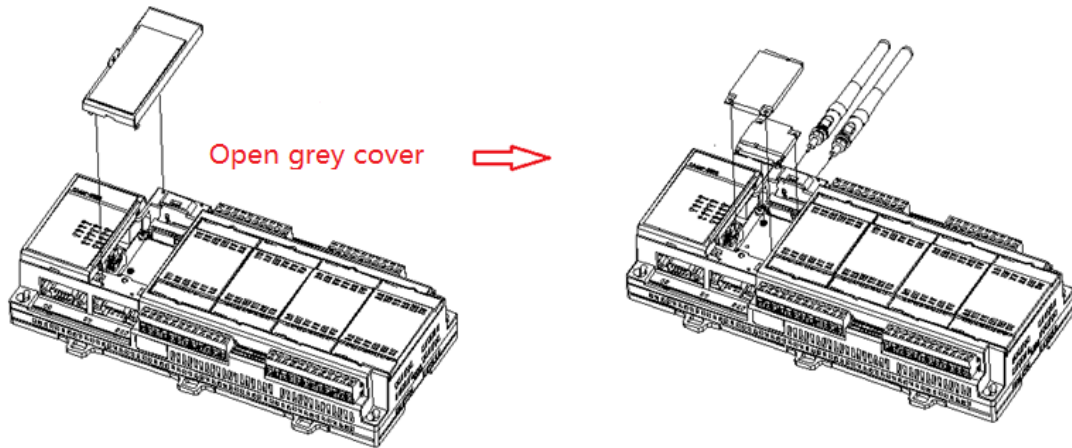

Figure 3.8 Wireless Module Installation

3.2.3 Expansion Input/Output Module Installation

The ADAM-3600-C2G has four expansion slots named A, B, C and D with a black cover. The following is the installation methods when customers need to plug expansion modules.

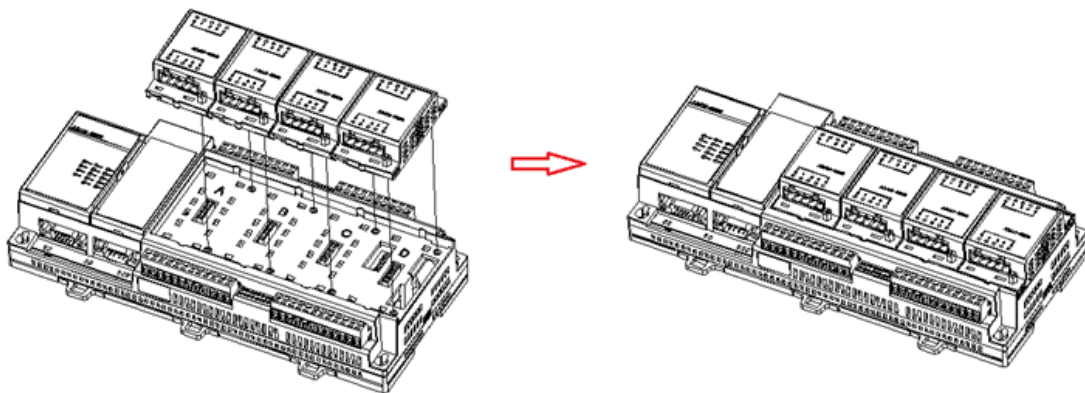

Figure 3.9 Expansion Input/Output Module Installation

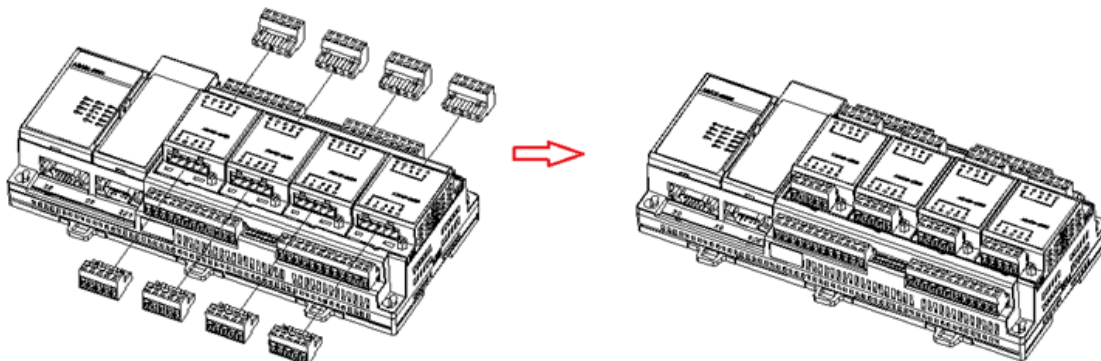

Figure 3.10 Expansion Input/Output Module Installation

3.2.4 Writeable Label

To make it more convenient for users to record RTU device information, we especially design a writeable label on the cover. User can write any information to help to keep some important project information.

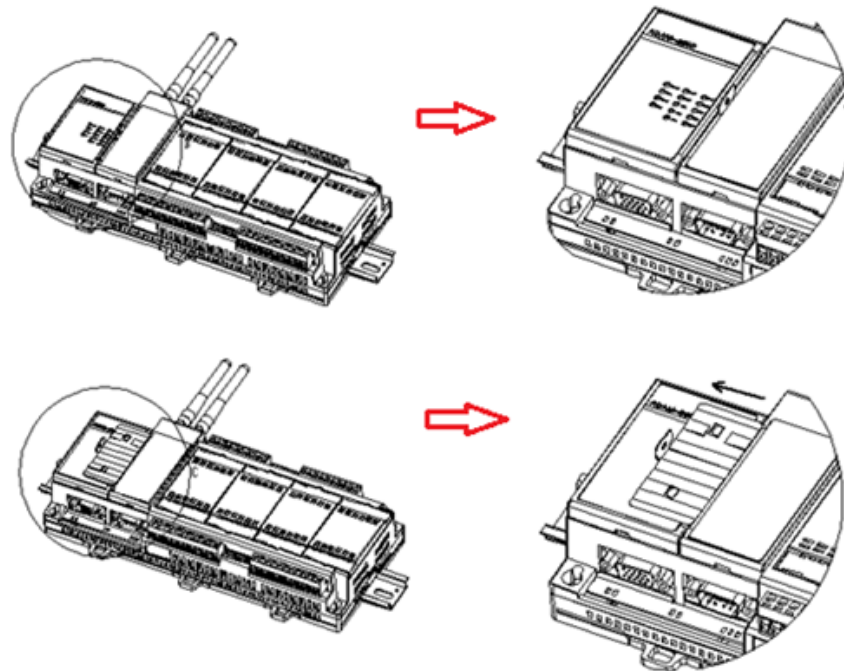

Figure 3.11 Writeable Label

3.2.5 SD Card Installation

The ADAM-3600-C2G supports two types of SD cards used as storage. One is Micro-SD, which carries the OS. The other is a Standard SD for storing data. It is available for users to choose and configure. The installation location of Standard SD is at the bottom of the antenna, poke the black blade upward, and you will find the slot, insert the SD card, push the black cover downward as follows:

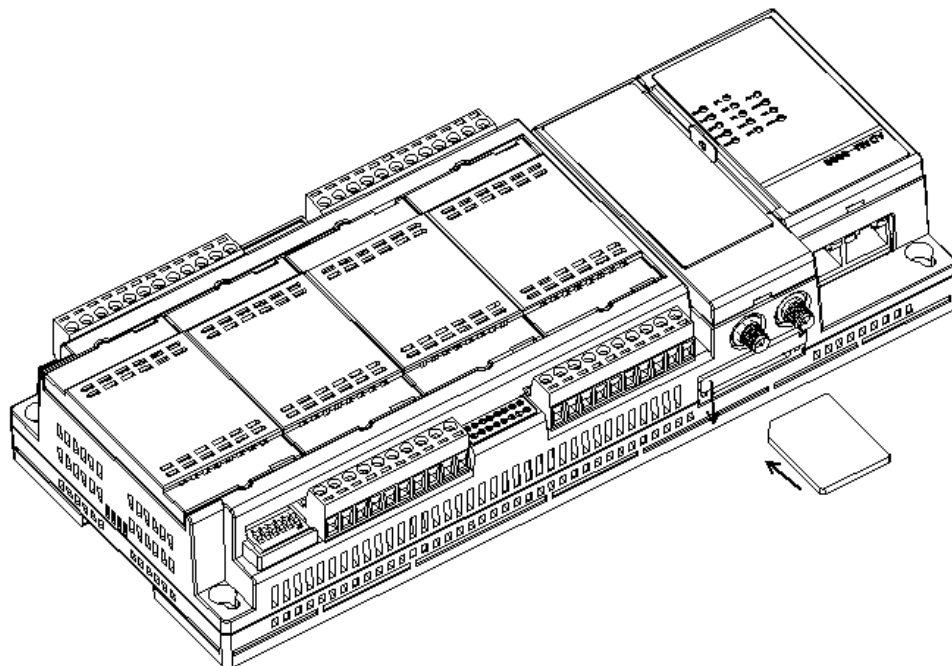

Figure 3.12 Card Installation

3.2.6 SIM Card Installation

When customers install a 3G/GPRS module, they need to insert a SIM card, follow below diagram to install the SIM card. The SIM card is micro-SIM (3FF) type.

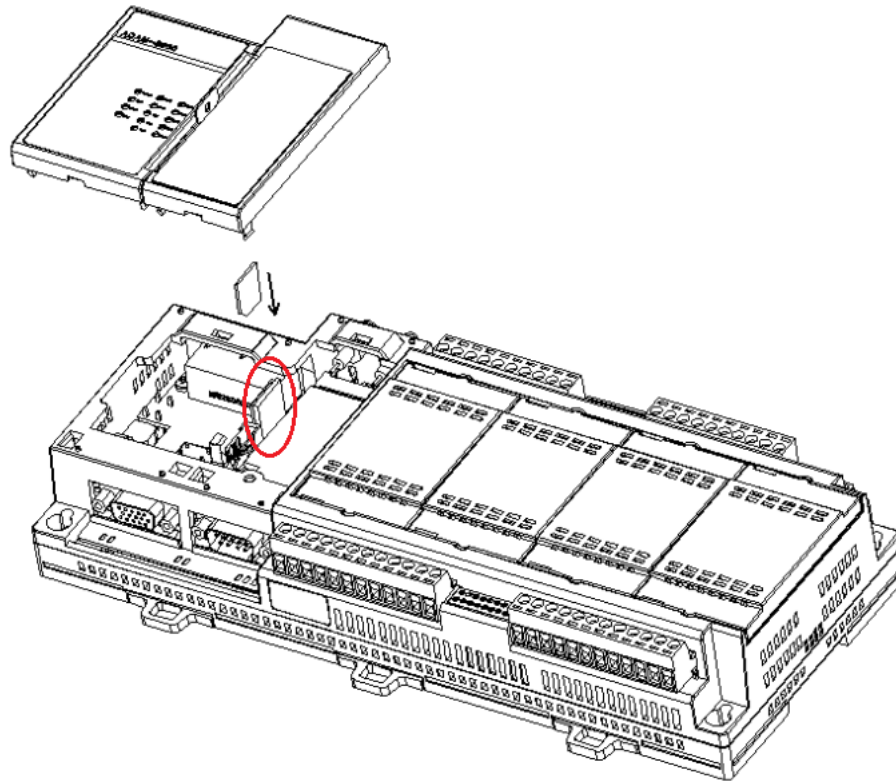

Figure 3.13 SIM Card Installation

3.3 Jumper/Switch Settings

3.3.1 DIP Switch Settings

ADAM-3600-C2G IO has two DIP switches as follows:

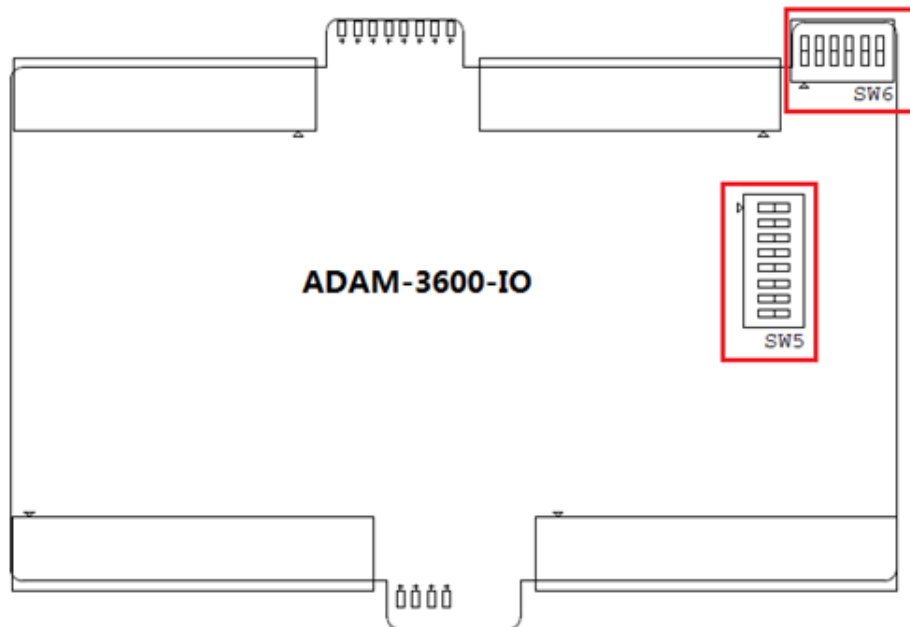

Figure 3.14 DIP Switch Setting

No.	Name	Meaning	Description
1	SW6	Node ID	6-bit: supports 0~63 devices ON-1/ OFF-0 1 is for high bit, 6 is for last bit, ex: [0 0 0 0 0 1] = 1 [1 0 0 0 0 0] = 32
2	SW5	8-ch AI Current or voltage range select	ON- Current OFF- Voltage

3.3.2 Jumper Settings

The ADAM-3600 CPU has two Jumpers as follows:

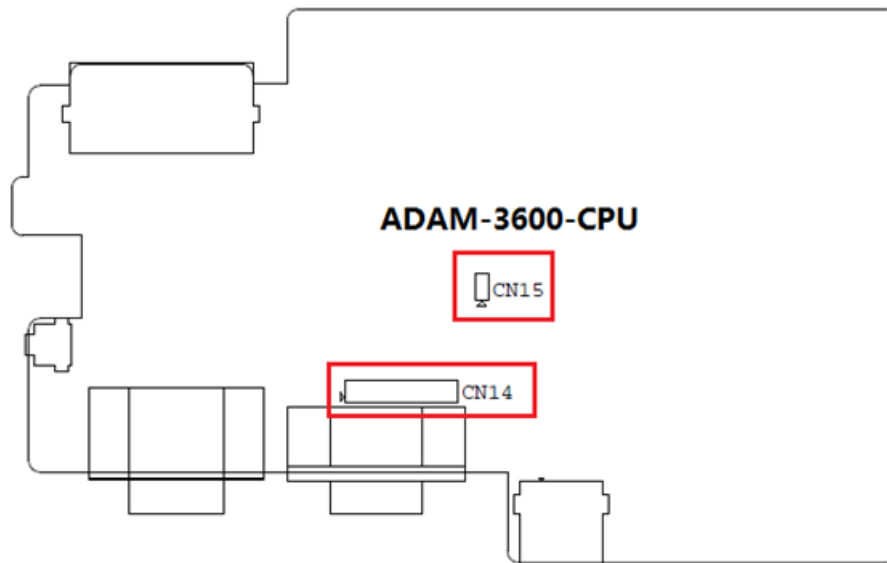

Figure 3.15 Jumper Settings

No.	Name	Meaning	Descriptions
1	CN14	COM1 DB9 Port select RS-232 or RS-485	RS-485 RS-232
2	CN15	Watchdog Enable Jumper	ON- Enable OFF- Disable

Chapter 4

Advantech iRTU
Studio

4.1 iRTU Studio Introduction

If there's one or more RTU devices in the field site it's more convenient for users if there is a tool to complete the integrated configuration and remote management. For this, Advantech developed a utility software to facilitate these tasks.

Advantech iRTU Studio can be operated in Windows XP/ Windows 7 system and has the following functions:

- Provide interface for off-line project configuration, and remote deploy the configuration base on the adjustable NodeID.
- Easy to configure the project tags with actual engineering meaning, and easy to map these tags to the Modbus and DNP3 services.
- Users could set each input and output range and support AI calibration for on onboard IO and Expansion IO.
- With regard to network communications, user can complete the settings for Ethernet, Wi-Fi, 3G and GPRS via iRTU Studio.
- ADAM-3600 provides Modbus/RTU, Modbus/TCP and DNP3.0 servers, and customers can flexibly choose protocol services according to their own needs.
- Advantech iRTU Studio Support remote monitoring of communication status of serial ports and Ethernet ports

Advantech iRTU Studio can be downloaded from Advantech support website:

<http://support.advantech.com/>

4.2 Using iRTU Studio for Configuration and Management

4.2.1 Project Initialization

Project Initialization can be achieved while users start iRTU software, and step by step complete '**Create Project**' -> **Right click to 'Add Device'** -> **Right click to 'Copy'** (for large number ADAM-3600 configuration)

4.2.1.1 Creating a new project

Start iRTU Studio software, click "create project" button under the taskbar "Project", and you will find the dialog box as follows, what you need to do is to input the project name, description and select the storage directory, then click "OK" button.

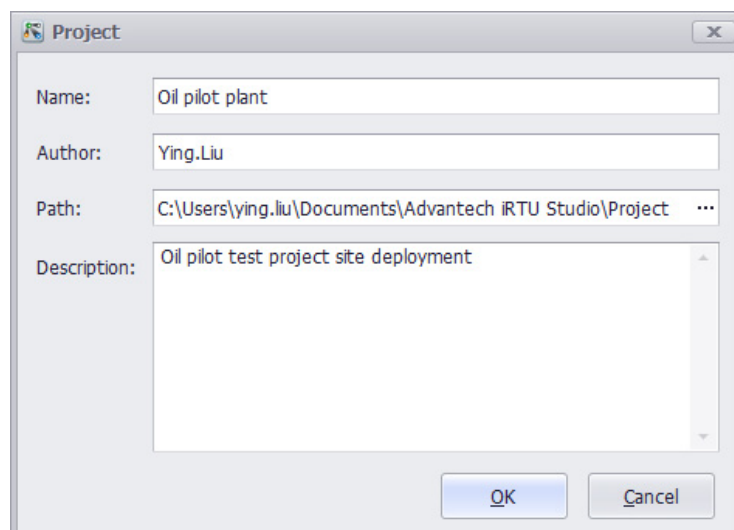

Figure 4.1 Creating a new project

4.2.1.2 Adding Devices and Editing a Project

After completing the creation of the new project, users can right-click on the project name to check the project information and add new devices. To add devices, user need to input the name, device type Node ID and description. The field of password contains the default setting; user can change it in “Deploy” taskbar “Password Setting”. See more details in Article 1-3-3

After finish the device adding, user's can modify the device information by double-click the device name on the left-hand-side tree view, or right-click on the device name, and choose “edit”.

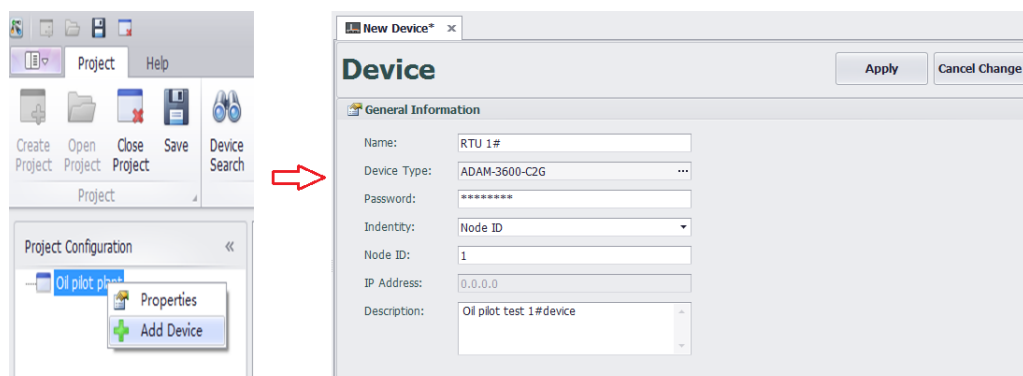

Figure 4.2 Adding Devices and Editing

4.2.1.3 Copying Devices

To reduce the complexity of configure a lot of ADAM-3600 on the field, iRTU Studio supports the ability to copy device information within a project. Users can right-click on the device name and choose “copy”. The copied device will have the same configuration as the original device, but user still need to be modify the name, NodeID or IP as well as the description according to the project planning.

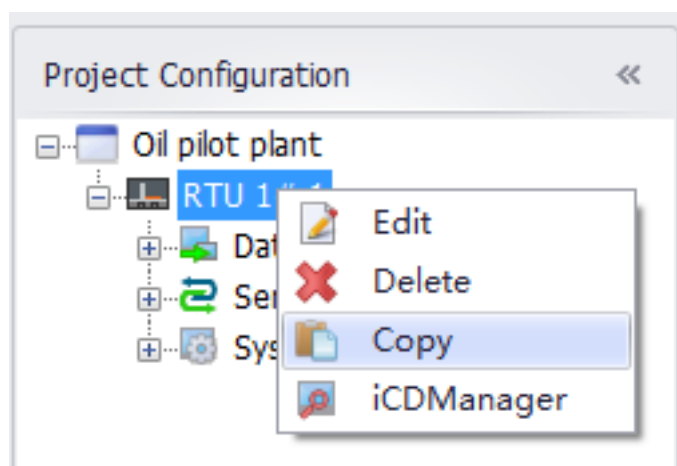

Figure 4.3 Copying Devices

4.2.1.4 Deleting Devices

Users can right-click on the device name and choose “delete” to delete a device in the project.

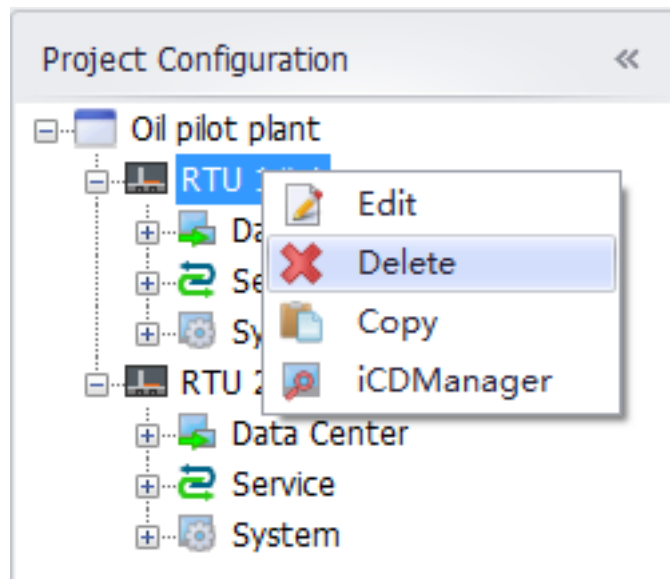

Figure 4.4 Deleting Devices

4.2.2 Configuring the Data Center and Link Tag with I/O

After adding a device, there will be an item "Data Center" under the added device. It is a place for user to manage data acquisition, which is an important functionality for a RTU. Through this interface, user can manage all the ADAM-3600 resources which are able to fetch data from the field site.

The ADAM-3600 can support many interfaces for data acquisition, include on-board I/O, expansion I/O, serial device I/O, Ethernet device IO, and Wireless Zigbee device I/O. All these above I/Os can be configured as a tag by using the iRTU Studio.

Beside the real I/O tags, user can also build some user tags which is with specific engineering purpose for management under the iRTU Studio

4.2.2.1 OnBoard I/O Configuration

The ADAM-3600-C2G is equipped with 8-ch AI, 8-ch DI, and 4-ch DO ports which users can map the real input signals to the IO tag. The configuration method of analog and discrete input is different and the specific configuration method is as follows:

■ Onboard IO Analog Configuration

Besides the basic information of IO tag, the configuration of analog also includes advanced configuration. The specified way is as the following figure shows.

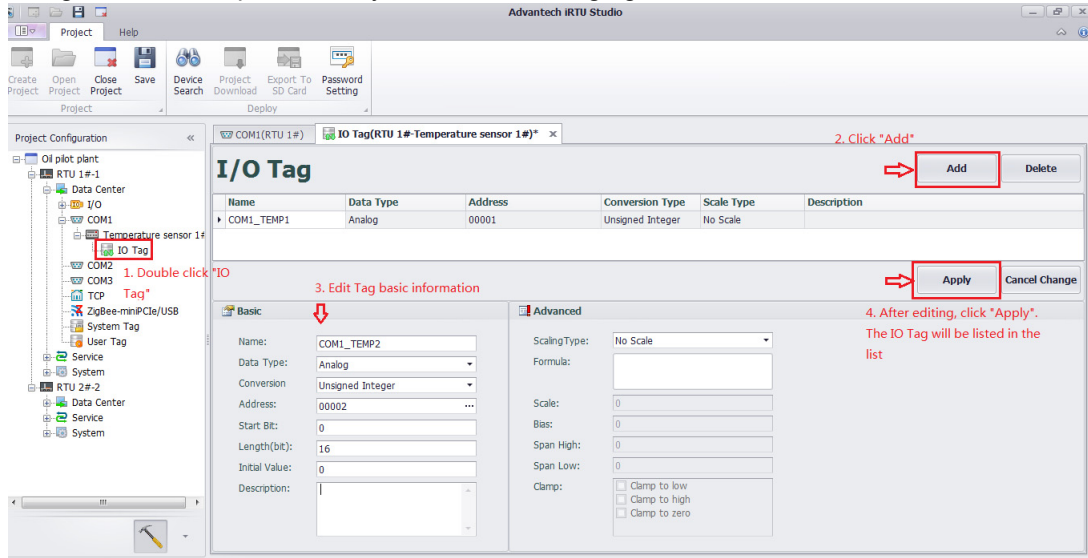

Figure 4.5 Configuring Onboard I/O Analog

■ Onboard IO Discrete Configuration

Configuration of the discrete onboard IO is identical with analog configuration, except that it has no advanced configuration. Moreover, ADAM-3600-C2G's on board DI and DO could separately provide counter and Pulse Width Modulation (PWM) function. Users can set these functions as described in 4-2-6-2. After selecting Counter and PWM functions, users have to configure them through iRTU Studio. The specific configuration method is as follows.

– Counter Function Configuration

The DI interface's counter function could compute the number of pulses within a certain sample time. Users can configure it as the following figure shows.

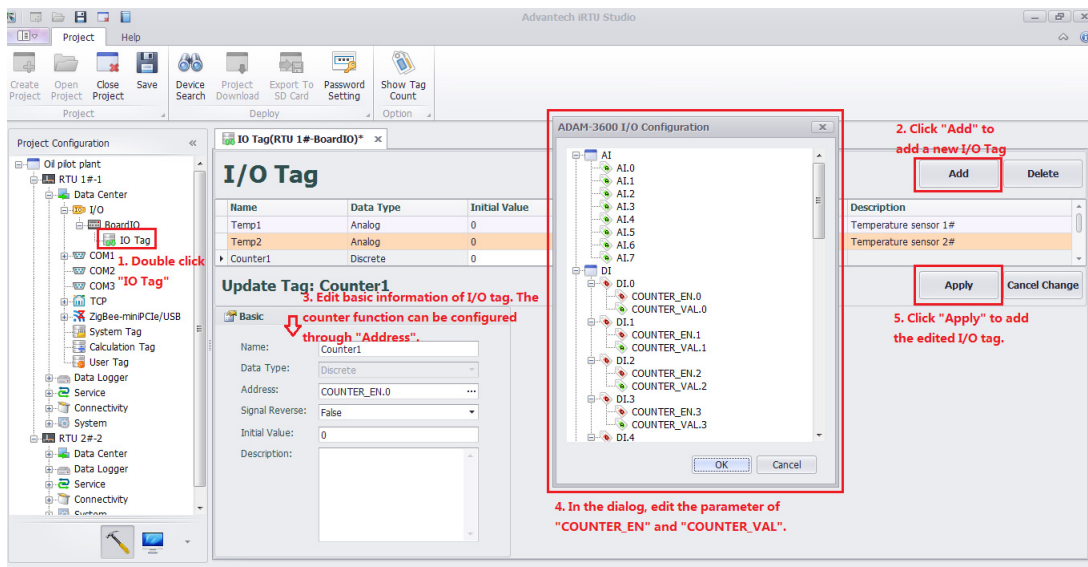

Figure 4.6 DI interfaces counter function configuration

With configuring counter function, some parameters are required and their meaning and setting are as follows:

Counter_EN: counter enable. The data type is discrete and the value can only be “0” or “1”. Users can set the initial value and signal reverse. When the signal reverse is “True”, it means that DI interface enable the counter function with value of “1”; Otherwise, when the signal reverse is “False”, it means that DI interface enable the counter function with the value of “0”.

Counter_VAL: counter value displaying current value of the counter. The data type is analog. Users can set the initial value through iRTU Studio. Another function of Counter_VAL is that users can reset the counter through making it equals to “0”.

– PWM Function Configuration

The DO interface’s PWM function could output the square wave signal with the specified duty cycle and frequency. Users can configure it as the following figure shows.

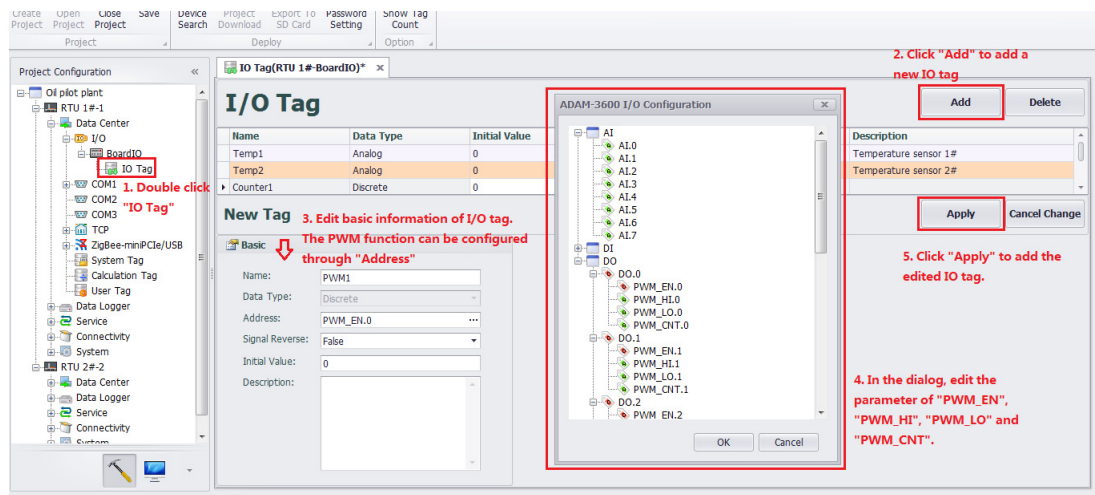

Figure 4.7 DO interface PWM function configuration

When configuring PWM function, some parameters are required and their meaning and setting are as follows:

PWM_EN: PWM enable. The data type is discrete and the value can only be “0” or “1”. Users can set the initial value and signal reverse. When the signal reverse is “True”, it means that DO interface enable the PWM function with value of “1”; Otherwise, when the signal reverse is “False”, it means that DO interface enable the PWM function with the value of “0”.

PWM_HI: the duration time of PWM high level. The data type is analog of 32 bits and the unit is 0.1ms. The value range is [(1~4294967295) x0.1ms+0.1ms]. In the initial status, the value is 0.

PWM_LO: the duration time of PWM low level. The data type is analog of 32 bits and the unit is 0.1ms. The value range is [(1~4294967295) x0.1ms+0.1ms]. In the initial status, the value is 0.

PWM_CNT: the DO’s output number of square wave signal. The data type is analog and the initial status is “0” under default condition. Users can modify the initial value through iRTU Studio.

With the duration time of high level and low level, the frequency and duty cycle can be calculated. The PWM period is the sum of duration of high level and low level, namely PWM_HI+ PWM_LO. The PWM frequency is 1/ (PWM_HI+ PWM_LO). The PWM duty cycle is the ratio of duration time of high level and PWM period, namely PWM_HI/ (PWM_HI+ PWM_LO).

4.2.2.2 Serial I/O Device Configuration

The ADAM-3600 has three serial ports including 1x RS232/RS485, 2 x RS485. iRTU Studio can edit, delete and add device on these three ports.

1. Right click the “Data Center” on the left-side tree view, and select “Add Port”
2. In the “Type” field of “New Port” page, select "Serial", and input the related parameters for the serial port.
3. Click button “Apply”, the port will be created on the left-hand side tree view under the “Data Center” item

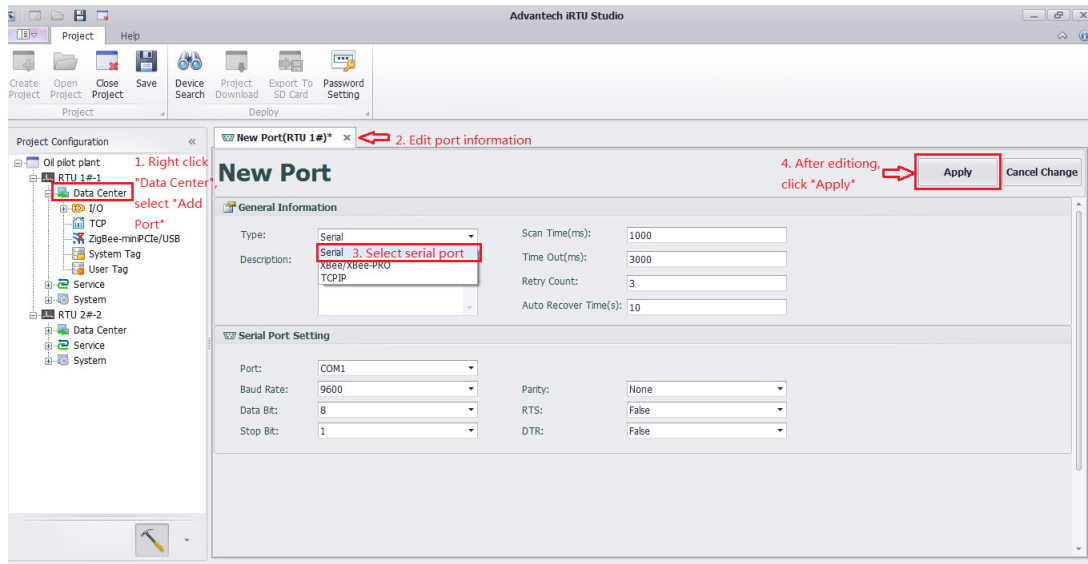

Figure 4.8 Adding COM port

4. Right click the “COMx” item created on the previous step and select “Add Meter” to add meter.
5. In the “New Meter” page, type in the name and related parameters, and click “Apply” to add meter. While the meter added, there is a new item “I/O Tag” below the meter, click the “+” in front of the COM port and meter to unfold it.

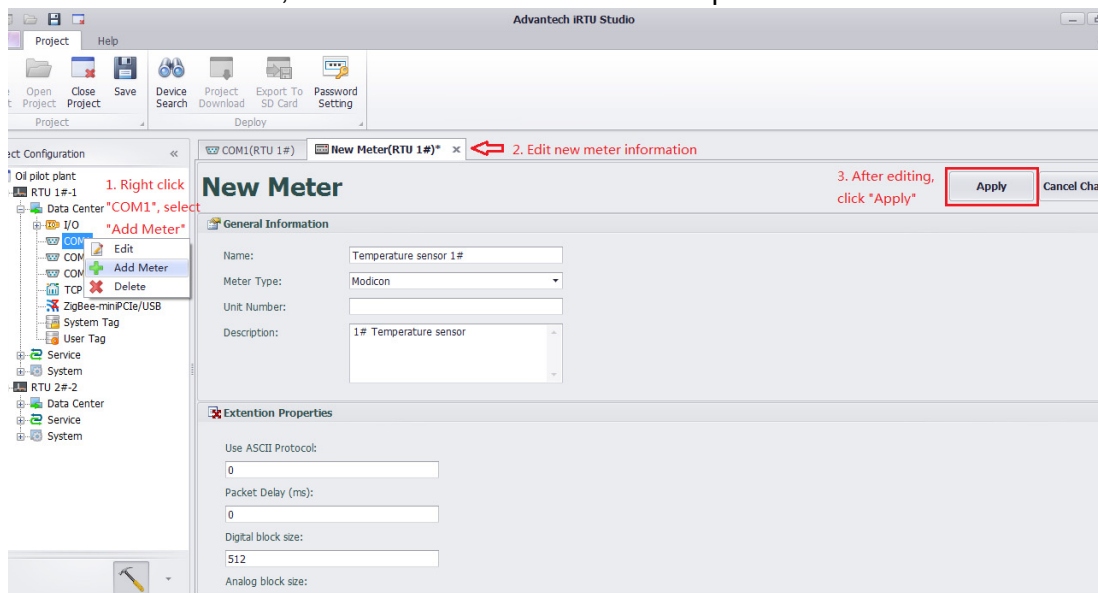

Figure 4.9 Adding a COM meter

6. Double click the “IO Tag” item to edit the tag to map with the data from serial meter.
7. To delete a COM port or a meter, right click to the select the target item and select “Delete”.

4.2.2.3 Ethernet I/O Device Configuration

ADAM-3600 is equipped two Ethernet ports; user can edit, delete and add devices through IRTU Studio.

1. Double click or right click the “TCP” item under the “Data Center” in the left side tree view and choose “edit” as shown in the following figure to edit the port.

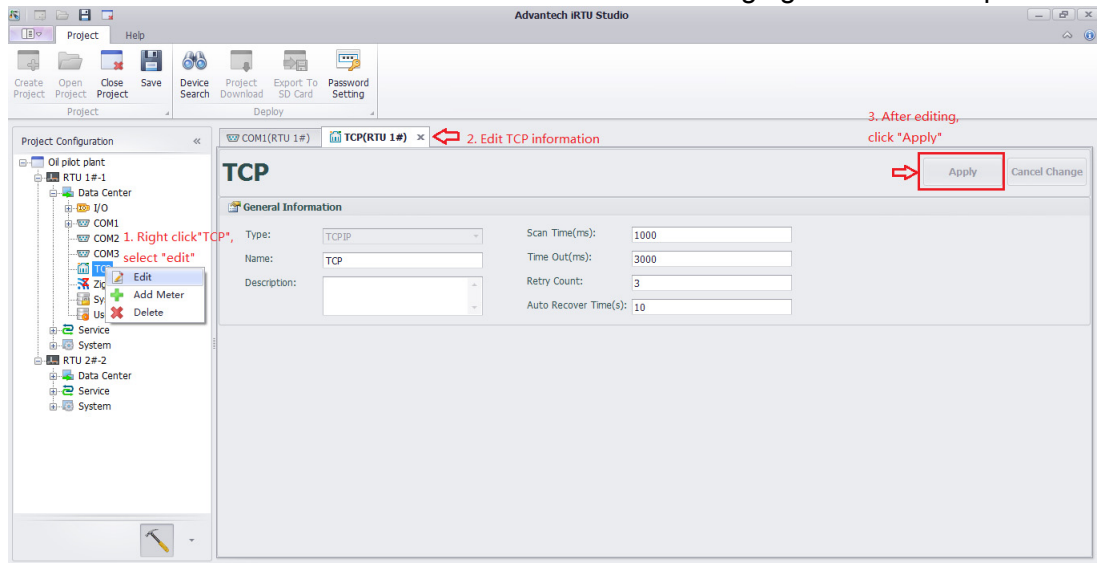

Figure 4.10 Editing TCP Information

2. Right click “TCP” item, choose “Delete”, the port will be deleted after your confirmation.
3. Right click “TCP” item, choose “Add Meter” to add a meter.
4. In the “New Meter” page, type in the name and related parameters, and click “Apply” to add meter. While the meter added, there is a new item “I/O Tag” below the meter, click the “+” in front of the port and meter to unfold it.

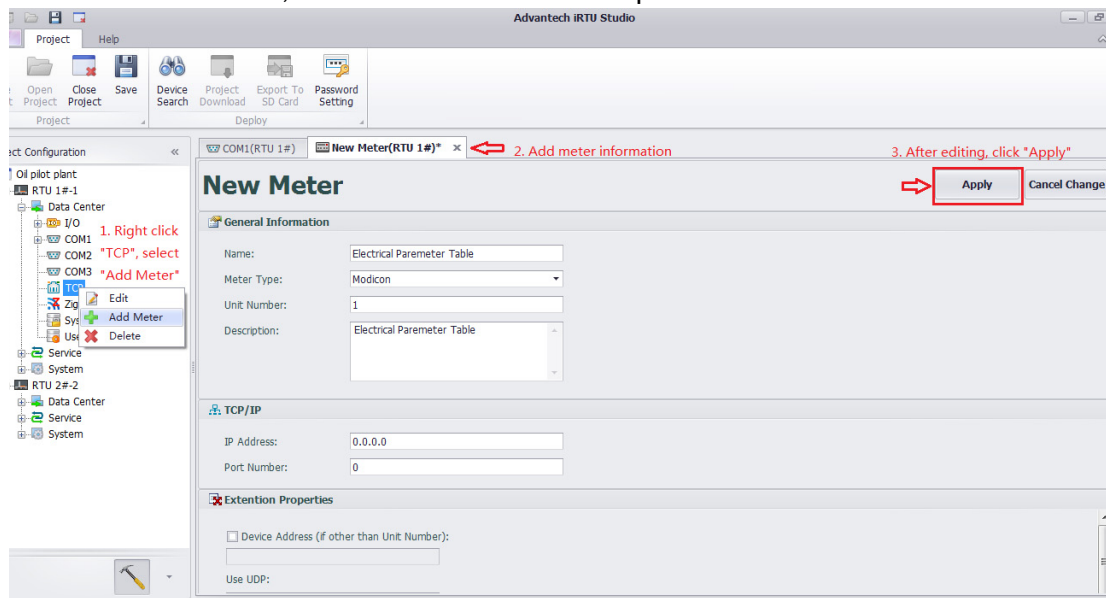

Figure 4.11 Adding and Deleting a TCP Meter

- Double click the "I/O Tag" item to edit the tag to map with the data from Ethernet meter.

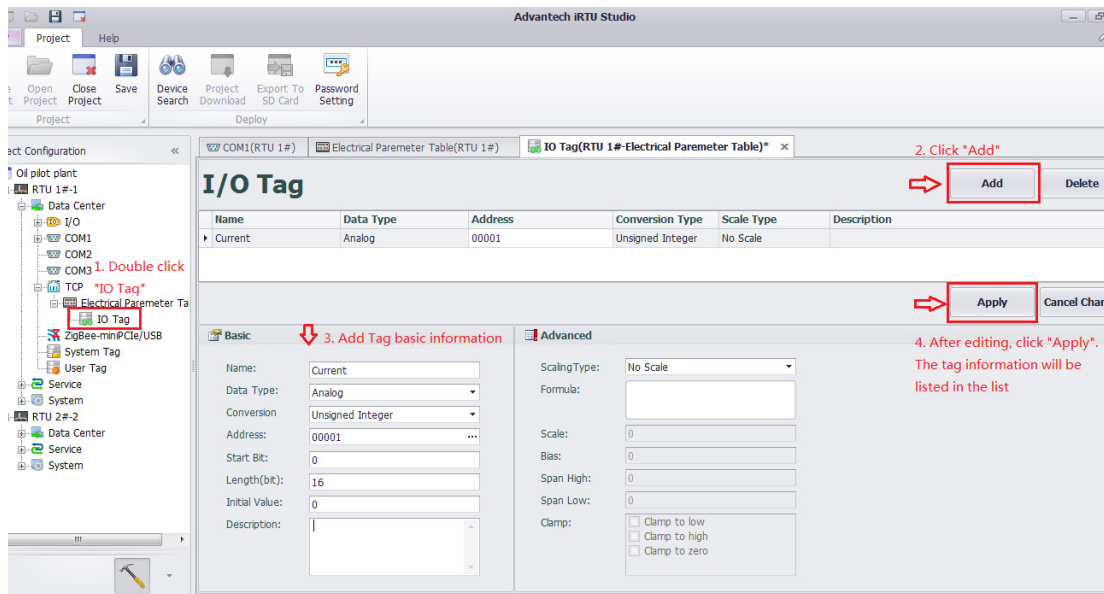

Figure 4.12 Configuring a TCP Meters I/O

- iRTU Studio default provide 1 TCP port for Ethernet IO configuration, if user need another TCP port, please right click on the "Data Center" and select "Add Port".
- In the "Type" field of "New Port" page, select "TCPIP", and input the related parameters for the serial port. Then click button "Apply", a new TCP port will be created.

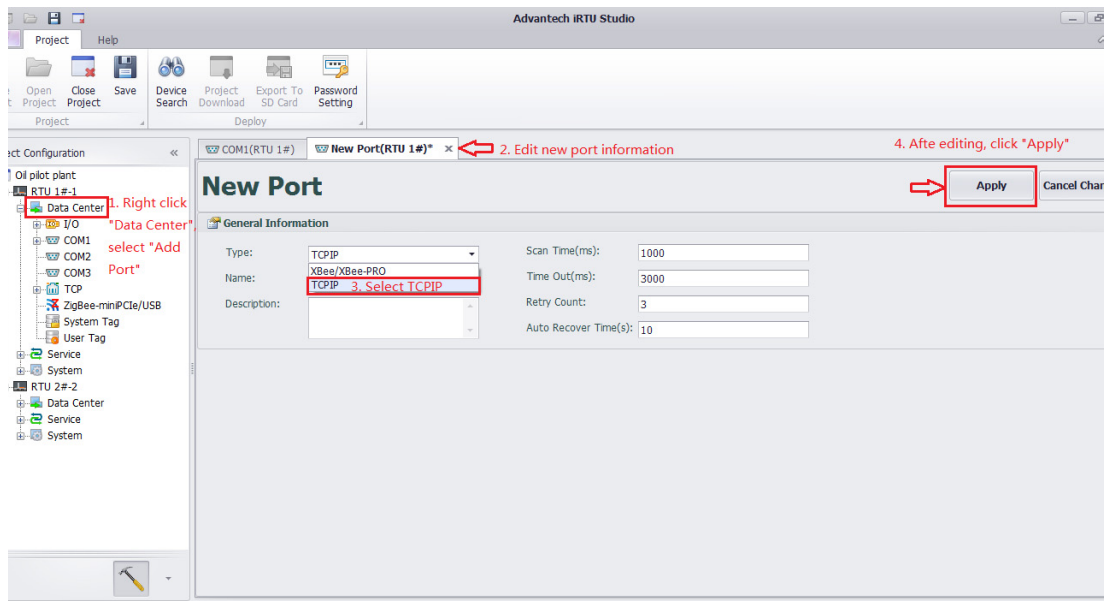

Figure 4.13 Adding and Editing TCP Ports

4.2.2.4 Zigbee Wireless I/O Device Configuration

A Zigbee wireless communication module can be added to the ADAM-3600 from COM port or USB port on PCIe-mini card socket. To get data from the Zigbee Wireless Meter, use the following steps:

1. Right click the “Data Center” on the left-side tree view, and select “Add Port”
2. In the “Type” field of “New Port” page, select “XBee/XBee-PRO” which is the supported Zigbee driver for ADAM-3600.
3. In the section of “Serial Port Setting”, please select the port where the Zigbee communication module connects to and adjust related parameter to communicate with the module. Please note if the resource is shown on the tree view, it is occupied by other meter, the resource will not be shown on the drop-down menu of the “Port” field.
4. Click button “Apply”, the port will be created on the left-hand side tree view under the “Data Center” item.

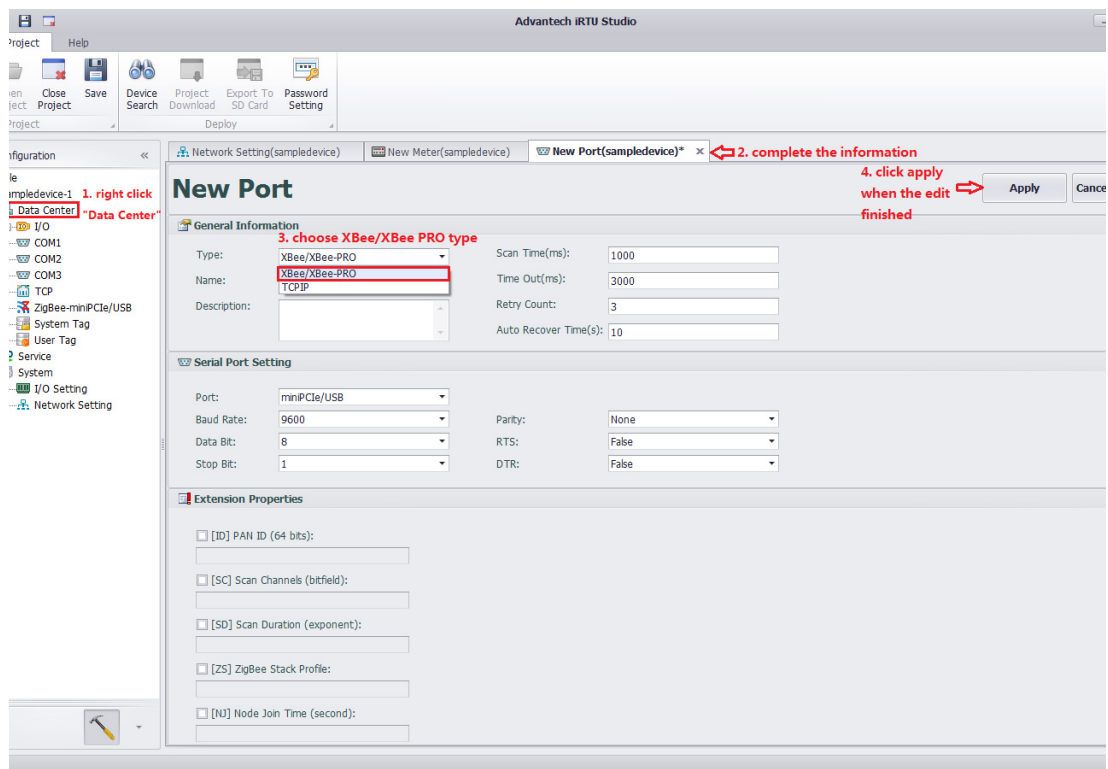

Figure 4.14 Adding a New ZigBee Port

5. Right click the port created on the previous step and select “Add Meter” to add meter.

- In the “New Meter” page, type in the name and related parameters, and click “Apply” to add meter. While the meter added, there is a new item “I/O Tag” below the meter, click the “+” in front of the port and meter to unfold it.

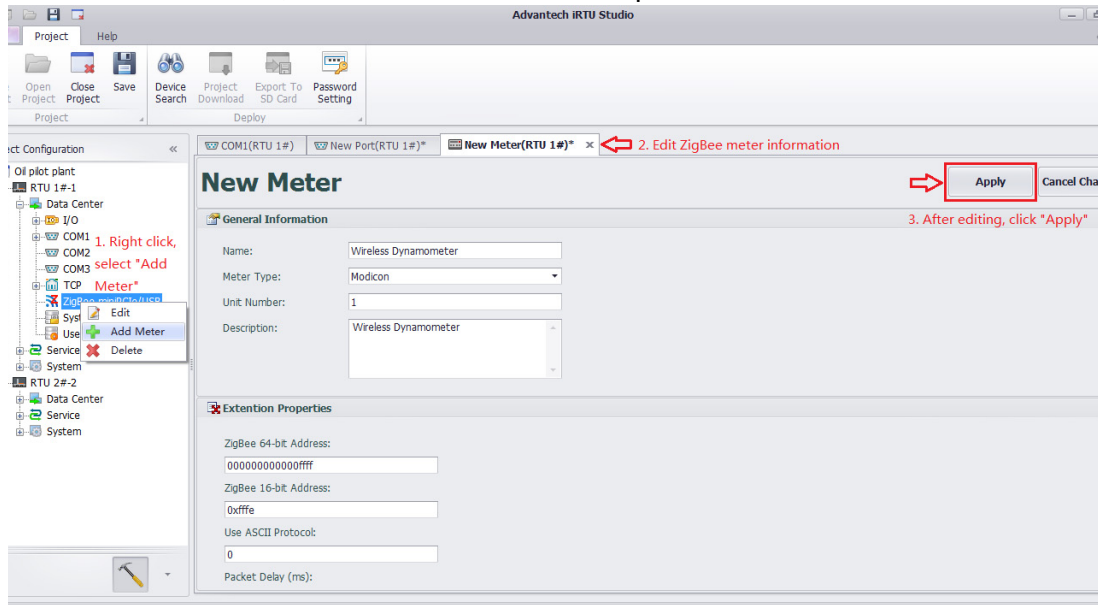

Figure 4.15 Adding a ZigBee Meter

- Double click the “I/O Tag” item to edit the tag to map with the data from Zigbee wireless meter.

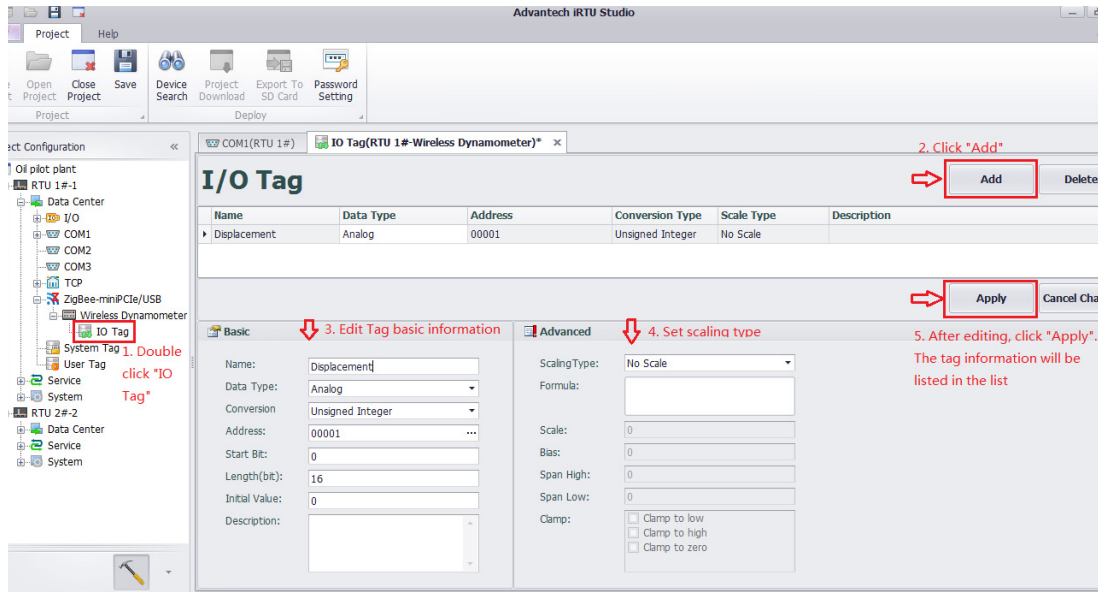

Figure 4.16 ZigBee Meter I/O Configuration

- To delete a Zigbee port or a meter, right click to the select the target item and select “Delete”.

4.2.2.5 Computation Tag Configuration

Considering oil & gas and water industry variables cannot be measured directly or the cost is very high, users can apply computation tag configuration function provided by iRTU Studio to approximate the variable through computation of the existing variables. In addition, sometimes users have to program to get user tags. With computation tag configuration function, users do not need to program and just configure it through iRTU Studio.

iRTU Studio provides many operations, including basic arithmetic, simple functions, trigonometric functions, logical judgements, Boolean operations, etc. The specific operation flow is as follows:

1. Firstly select the acquisition tag, represented by A, B, C, D..., respectively.

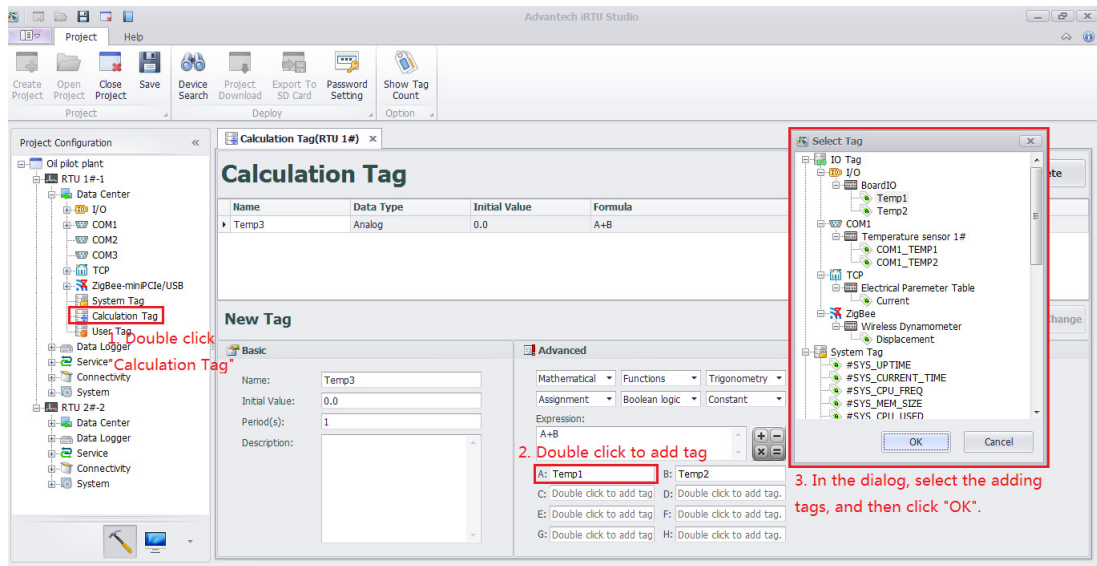

Figure 4.17 Adding the acquisition tag

2. Determine the expression according to the requirements. Then select the “Application” button to add the computing tag.

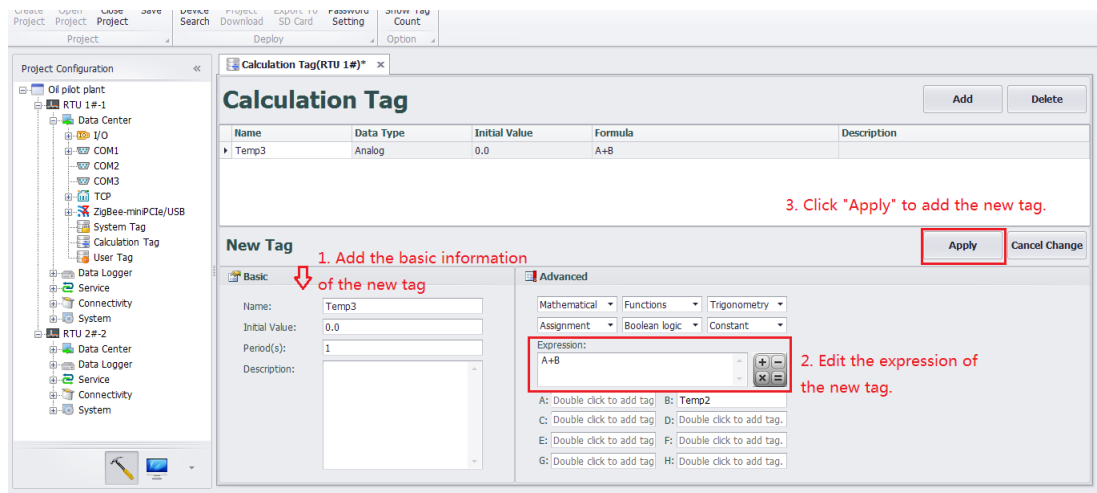

Figure 4.18 Adding the computation tag

4.2.2.6 User Tag Configuration

We mainly introduced I/O tag configuration in the former articles, while there are some non-actual I/O tags in the project configuration, which allow users to choose and configure. This is called as user tag. These user tags could be used for C language and KW language programming as a control signal as well as a presentation of computation results. In a word, all of these user tags will fulfill user's demands for data.

iRTU Studio supports user tag configuration. Users can configure step by step into RTU as shown in the following:

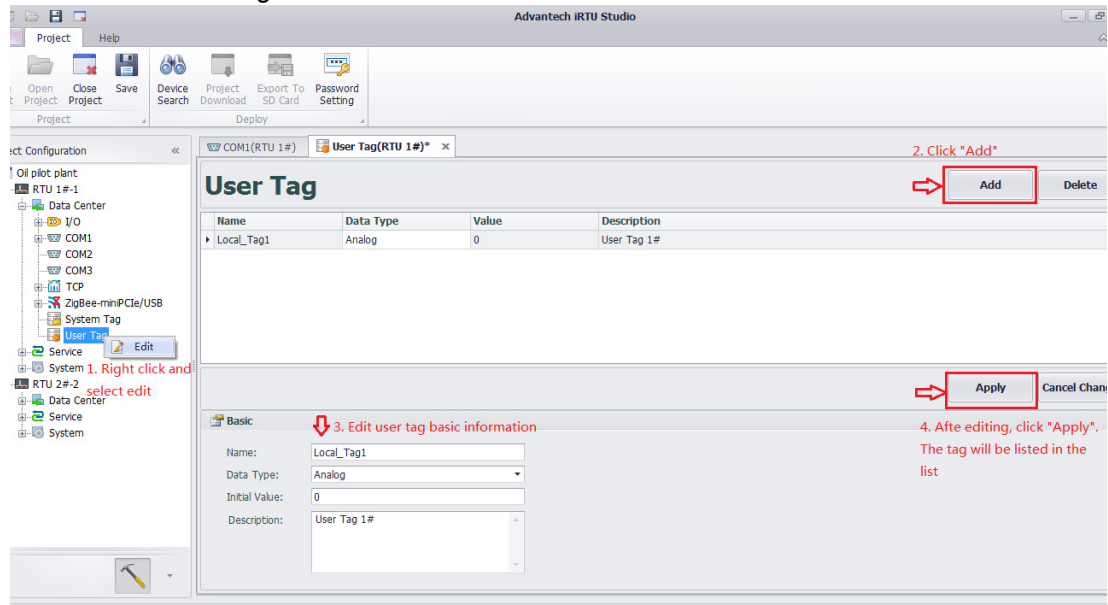

Figure 4.19 User Tag Configuration

4.2.3 Data Logger Configuration

For the convenience of recording acquisition tag's historical data, iRTU Studio provides data logger configuration function. Users can select the acquisition tag, recording period (seconds) and maximum recording days (day) according to the requirements. The historical data of each day is stored in a file, which is stored in a SD card. iRTU Studio can calculate the occupied memory in SD card of the historical data according to the recording period and recording days. Pay attention to the total memory of SD card, which must be bigger to the calculated memory. The specific parameter setting is as follows:

- Recording acquisition tag: the maximum is 200 tags.
- Recording period (second): Positive integer value.
- Recording maximum days (day): Integer value between 0~99.

In order to directly read the field data or prevent data loss caused by the communication instability, users can enable the USB backup function. In this way, users can directly insert the USB into the ADAM-3600-C2G to copy the historical data in SD card. PROM indicator will always be blinking until finishing the process of copying. The historical data is stored in the form of SQLite. If users want to read the file, please contact Advantech customer service. We will help you to read the data.

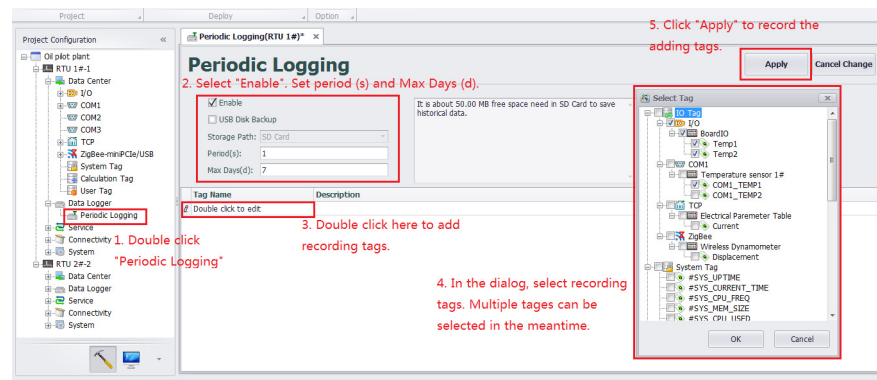

Figure 4.20 Historical recording data configuration

4.2.4 Protocol Service Configuration

The ADAM-3600-C2G is an open basis intelligent RTU which is able to integrate many kinds of communication protocol to communicate with the center station. And it is default with two standard protocol services: Modbus and DNP3.

4.2.4.1 Modbus Service

The ADAM-3600-C2G can be used as Modbus Server for Modbus Client accessing. There are two types of services supported: Modbus TCP Server and Modbus RTU Server

Users can check the Checkbox to enable the services, fill all the required parameters for these services and click "Apply".

Note if all the serial ports are occupied there will pop-up and error message while you enable the Modbus RTU Server. Go back to "Data Center" tree-view to release COM port resource. To release the COM port, right click on the resource and select "Delete", the resource will be remove from the "Data Center" configuration.

ADAM-3600-C2G Modbus address mapping: Modbus Client request data of Server by Modbus addressing. Thus, in the lower table is an interface to map the tags with Modbus address.

To add tag into Modbus address list, please double click the field of column "Tag Name" and select the tag from the tree-view as shown on below figure. And select the "Tag Type" from the draw down list. If the tag is an analogue type (AI/AO), please also select the related "Data Type" from the draw down list.

The “Modbus Address” is the address for client to access the tag data.

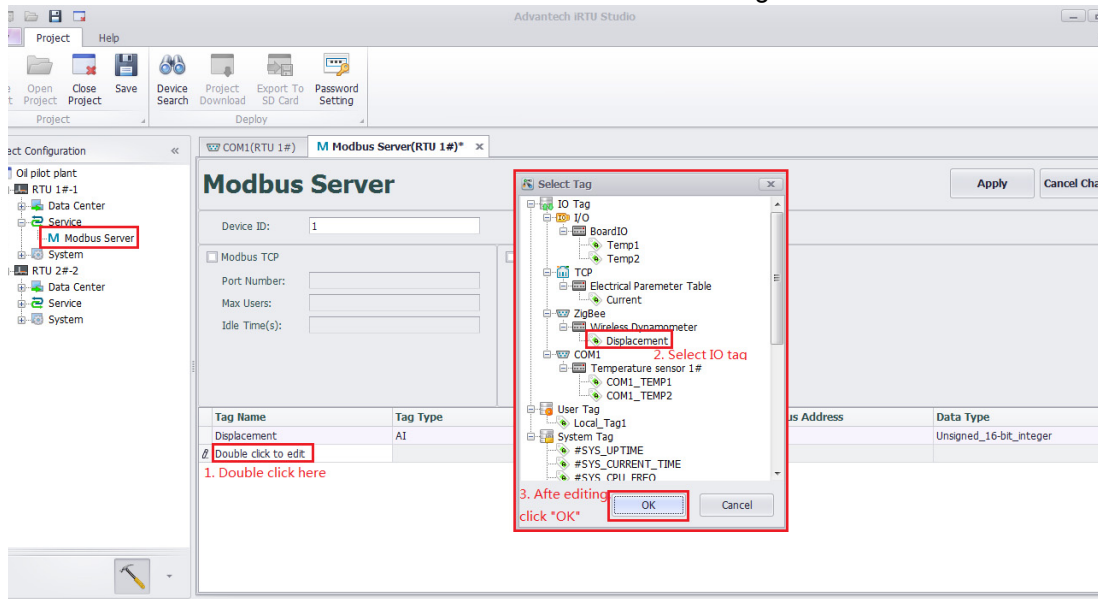

Figure 4.21 Adding I/O Tags to the Modbus Address List

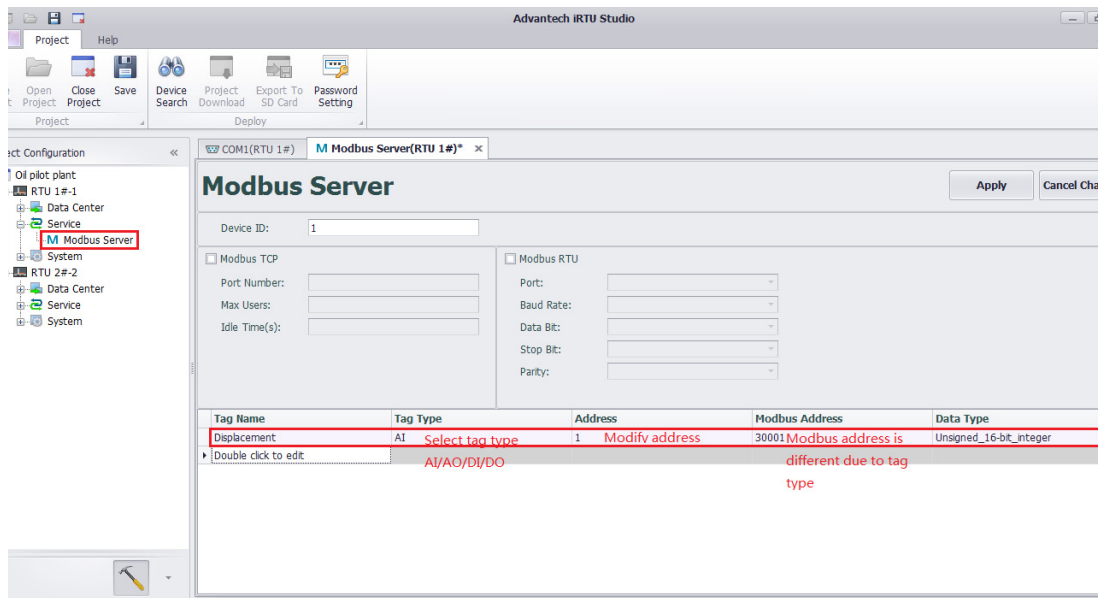

Figure 4.22 Adding I/O Tag Information

To connect with WebAccess, users should click WebAccess WhereIAm. Make sure that the physical IP address with WebAccess is right. The parameter definition as below:

- IP Address:** physical IP address with WebAccess;
- Port:** default TCP port for WebAccess;
- Period (s):** for connecting with WebAccess Center;

Duration (s): communication time; it should be shorter than Periods. the default value (0) means there is no interruption during communication with WebAccess.

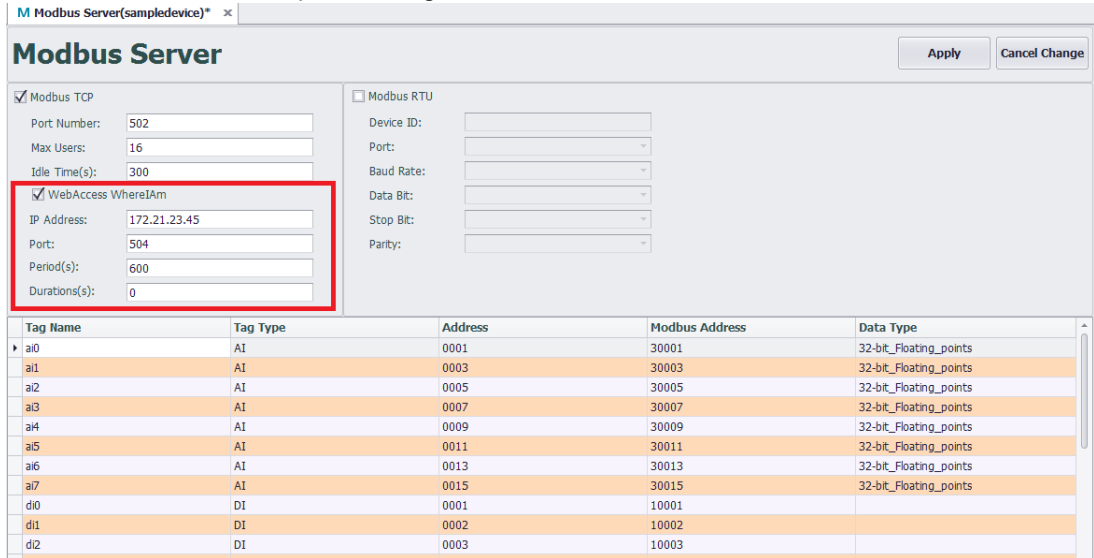

Figure 4.23 WebAccess whereIAM

4.2.5 Connectivity Configuration

The ADAM-3600-C2G is an Intelligent Remote Terminal Unit and acts as an intelligent network node in IoT. It can control the downstream field devices to complete delivery tasks and transfer data to upstream devices wired or wirelessly. As a key device, the connecting function of ADAM-3600-C2G is very important. Therefore, iRTU Studio provided users connectivity configuration function to select connection way and connection protocols.

4.2.5.1 Active Connection

In order to break the closed nature of internal network and make connection with the main station timely, ADAM-3600-C2G provides active connection function and users can configure the parameters in iRTU Studio. The specific configured parameters include:

- **Protocol:** There are two optional protocols: DTU-Four Faith PROT and Webaccess WhereIAM (in the case of the upper station is Webaccess). The specific operation will be different under different protocols, which will be described below.
- **Local Service:** Modbus RTU and Modbus TCP.
- **Binding Interface:** None, LAN1, LAN2, WLAN and Cellular. None represents that system auto routing network port.
- **Period(s):** The connecting interval that ADAM-3600-C2G provides active connection. Users can select the connection period according to the requirements.
- **Duration(s):** The time of each connection lasts. Users can also select the connection duration according to the requirements.
- **Idle time:** The time interval when there is no message being sent. The connection will automatically disconnect. When the idle time is set as 0, it indicates that the idle time is infinite.
- **Center lists:** Users can edit master station information including master station IP and station port.

The relationship among connection period, connection duration and idle time is shown in the following picture.

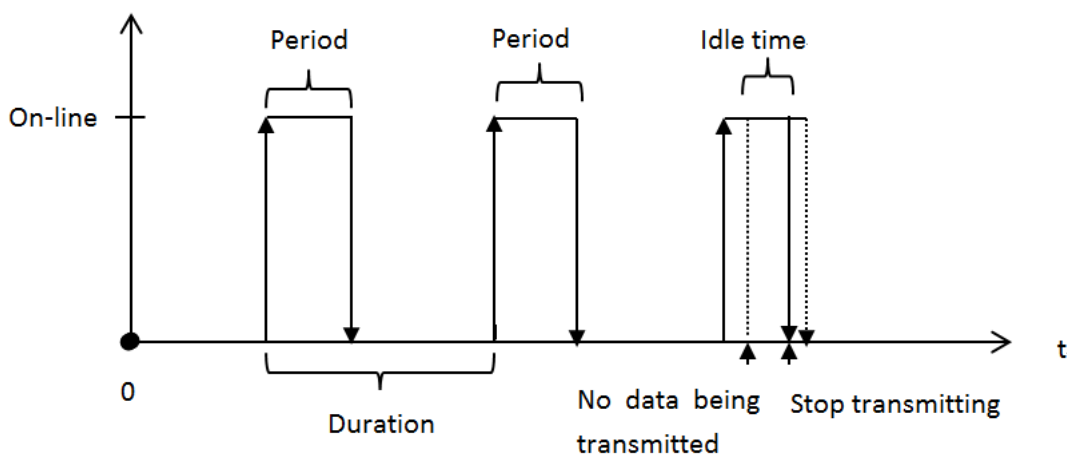

Figure 4.24 Relationship among connection period, connection duration and idle time

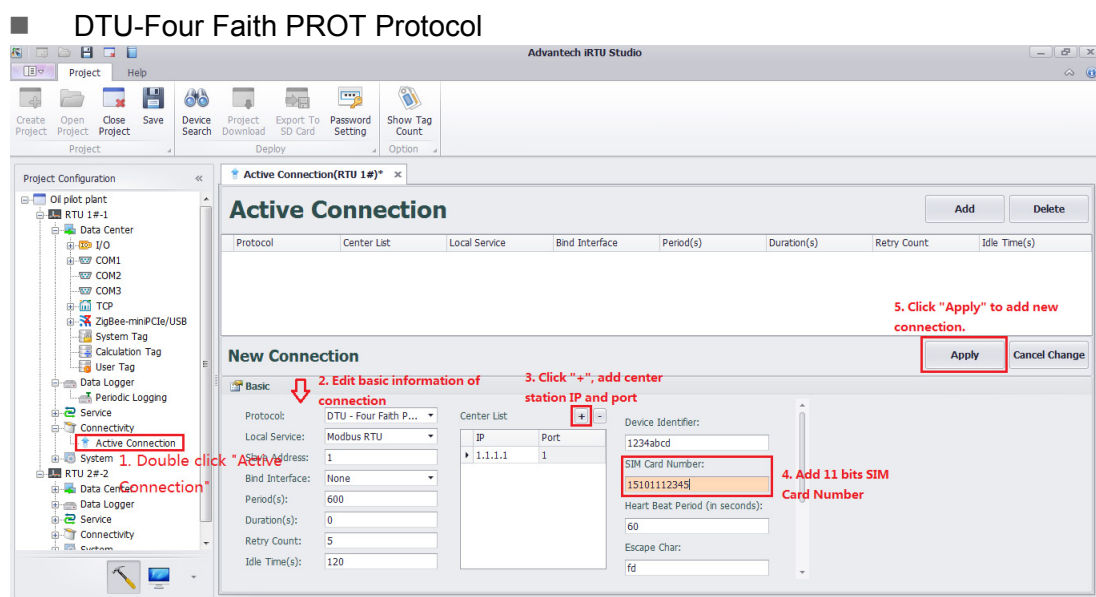

Figure 4.25 DTU-Four faith PROT protocol in active connection

The extra parameters are also required in the DTU-Four faith PROT protocol.

Device Identifier: It is applied for RTU identification and it should be 16 hex.

SIM Card Number: Here are 11 card numbers.

Heart Beat Period: It specifies the sending period of heartbeat char. When it is set as 0, it means that heart beat char is not transmitted.

Moreover, it has four kinds of chars: escape char, heart beat char, escaped heart beat char and escaped escape char.

Escape rules:

The heartbeat character is only for heart beat packet. The heart beat char can be escaped as < escape char > < escaped heart beat char >. The escape char can be escaped as < escape char > < escaped escape char >. By default, the escape char is fd, the heart beat char is fe, the escaped heart beat char is ee, and the escaped escape char is ed.

Escape rules of the sender:

fe => fd ee

fd => fd ed

Escape rules of the receiver

fd ee => fe

fd ed =>fd

When the send data is as follows: 01 0a fd cd fe fe 22, the escaped data is as follows: 01 0a fd ed cd fd ee fd ee 22.

■ Webaccess WhereIAm Protocol

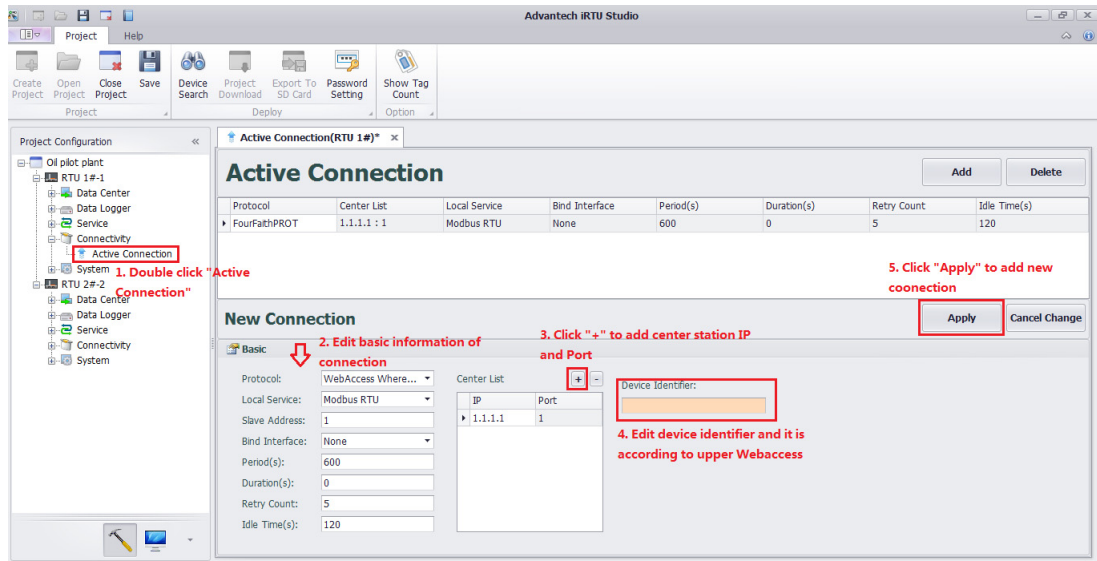

Figure 4.26 Webaccess WhereIAm Protocol in active connection

The additional Identifier Device parameter is required in Webaccess WhereIAm protocol. The identifier device number must correspond with the upper Webaccess and the length of the string is 1~60.

4.2.6 System Settings

The system setting of iRTU Studio includes two parts: I/O setting and network setting.

4.2.6.1 I/O Settings

The ADAM-3600-C2G is equipped with 8 AI channels, 8 DI channels, and 4 DO channels. Besides, there are four I/O expansion slots which can integrate various I/O modules into the main unit. In the Studio, for both on-board I/O and expansion I/O, user can set mode, I/O range, integration time as well as calibration.

Configure the I/O setting as below figures to provide an initiated setting to the on-board I/O and expansion I/O

- (1) AI supports 4 IO ranges: $\pm 10V, \pm 2.5V, 0 \sim 20mA, 4 \sim 20 mA$
- (2) DI supports 2 modes: Normal & Counter
- (3) DO supports 2 modes: Normal & PWM

The figure below shows the configuration page the ADAM-3600-C2G on-board IO; AI,DI,DO in the same page:

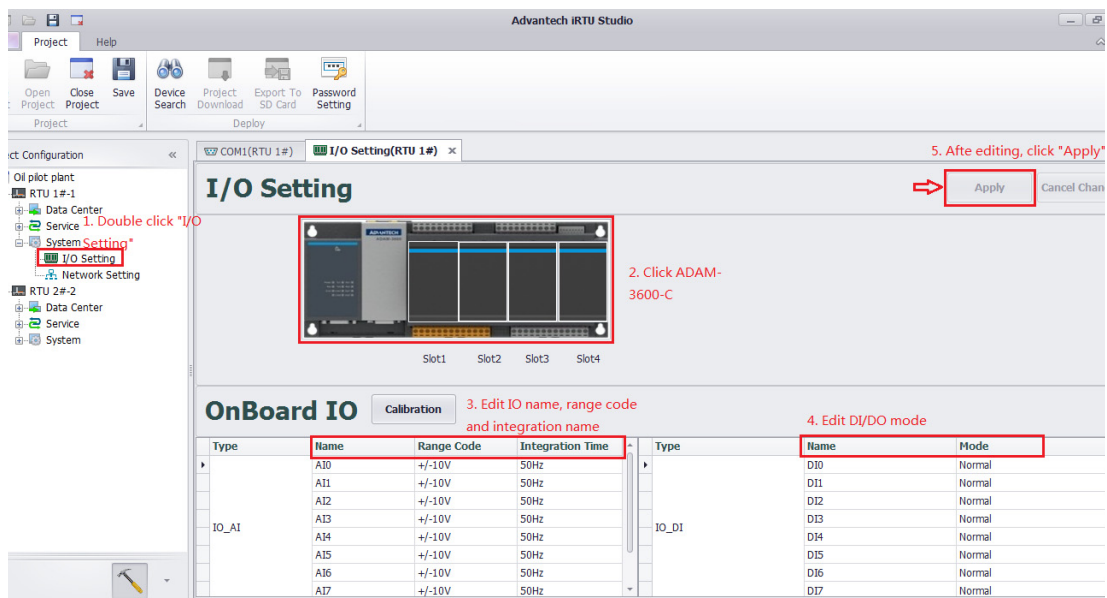

Figure 4.27 On-board I/O Settings

While configuring the expansion module, please click to select the target expansion slot first and select the module from the draw down list. Then configure the related setting by click and select from the related column, please refer to the figure below:

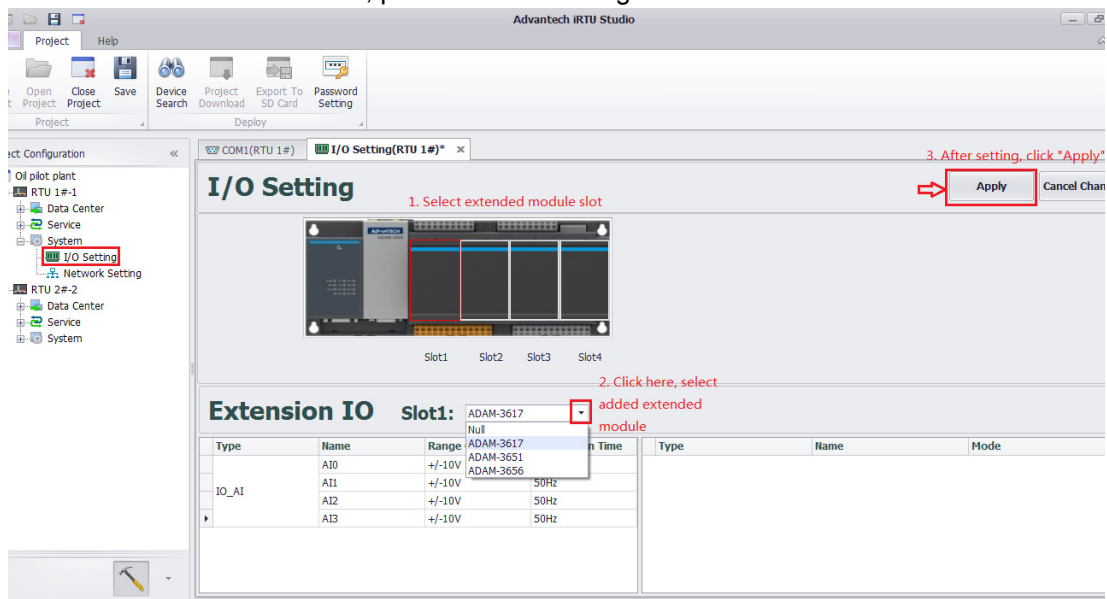

Figure 4.28 Expansion I/O Settings

Click the button “Calibration” to execute the calibration function for the analogue input channel on board. User has to provide the precious source for the zero and span calibration. User only need to calibrate the channel 0, the related parameter will apply to all other channels automatically. Please follow the instruction to finish the calibration.

Note! *The analogue I/O is default well calibrated and we do not recommend user do the calibration by one-self. Once the calibration is needed, we suggest sending back to RMA for calibration service.*



4.2.6.2 Network Function Setting

The ADAM-3600-C2G supports wired and wireless network connections to communicate with other devices. User has to configure the network environment in this section.

Cable Network Settings

The ADAM-3600-C2G has two Ethernet ports and users can configure them respectively. Under the concomitances that Ethernet ports supports IPv4 and IPv6, users can set RTU as DHCP or fixed IP. If users select RTU as DHCP mode, RTU will provide a default IP address when not getting an IP address.

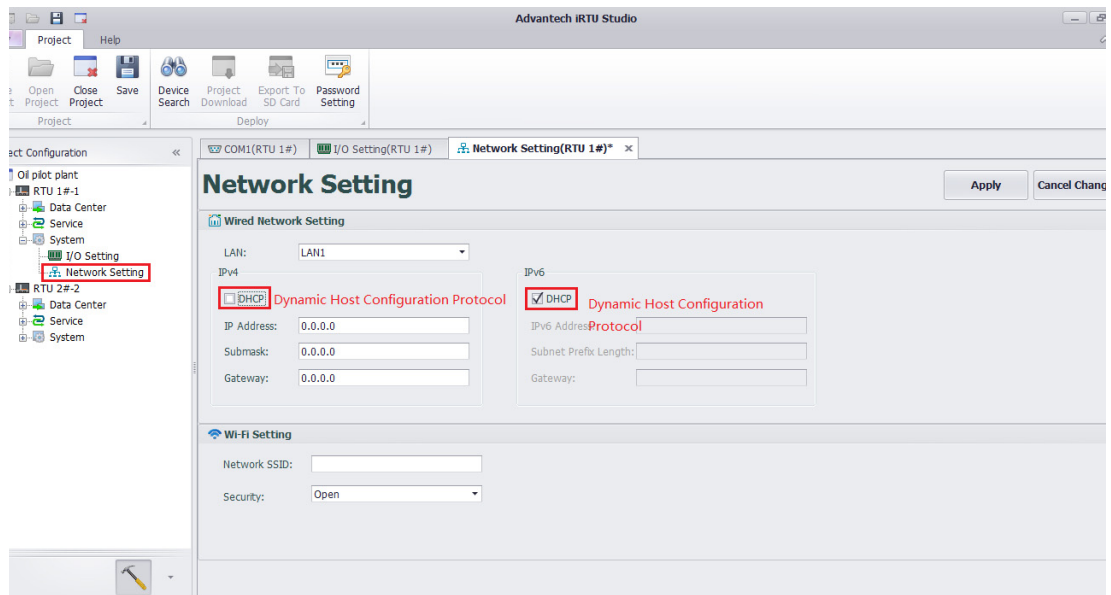

Figure 4.29 Wired Network Settings

Wireless Network Settings

In the Wi-Fi setting section, users have to input an SSID to join the network. For the network security, there are three mechanisms available:

Open: No password needed, the RTU will auto connect to the Wi-Fi network.

WEP: A kind of network encryption. Need password, check the password of connected Wi-Fi Access Point.

WPA/ WPA2 PSK: A kind of advanced network encryption. Need password, check the password of connected Wi-Fi Access Point.

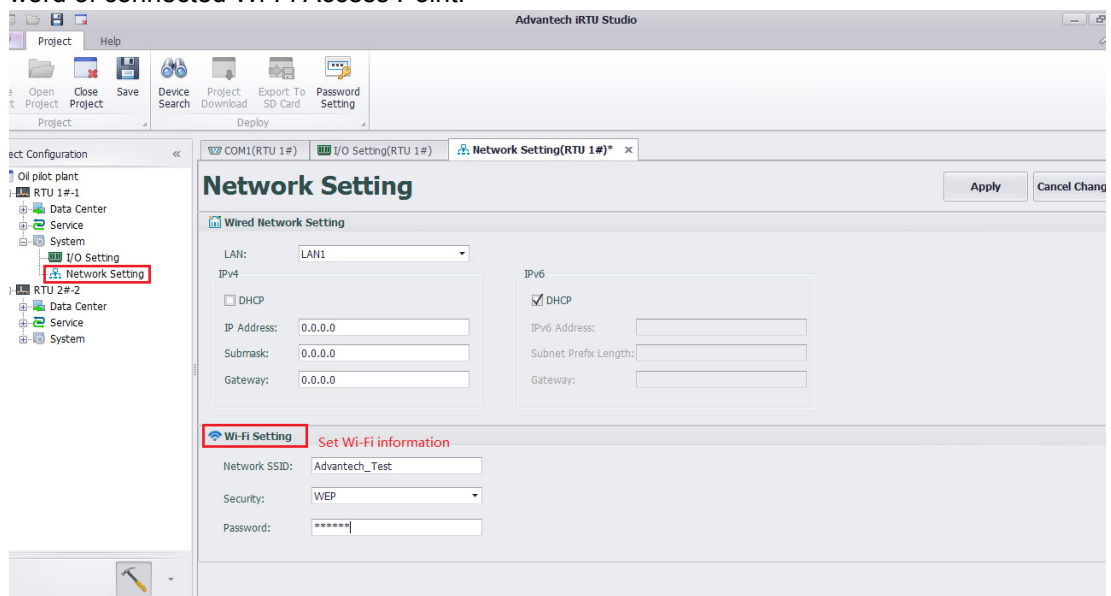

Figure 4.30 Wireless Network Settings

GPRS Settings

In the GPRS setting section, user has to choose the GPRS connection to join the network. and make sure the Connect has been clicked:

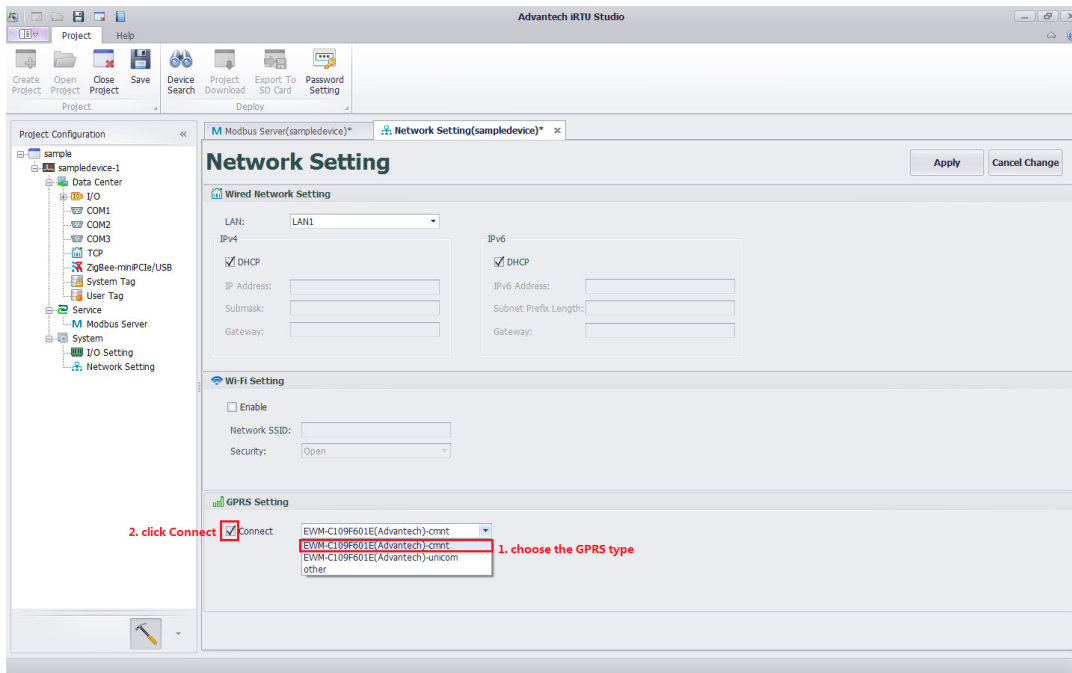

Figure 4.31 GPRS Settings

If there are different communicated modes applied. Users should make scripts.

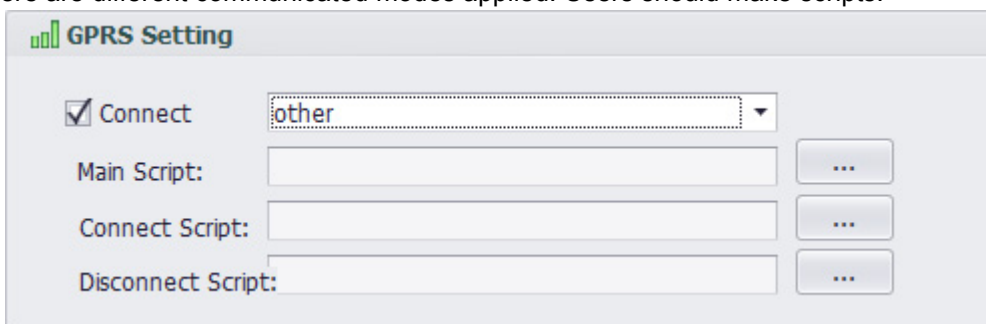

Figure 4.32 GPRS Script Setting

4.2.6.3 LED Configuration

The ADAM-3600-C2G has many system status indicators. Users can configure LED indicators through iRTU Studio to make it blink according to users' definition.

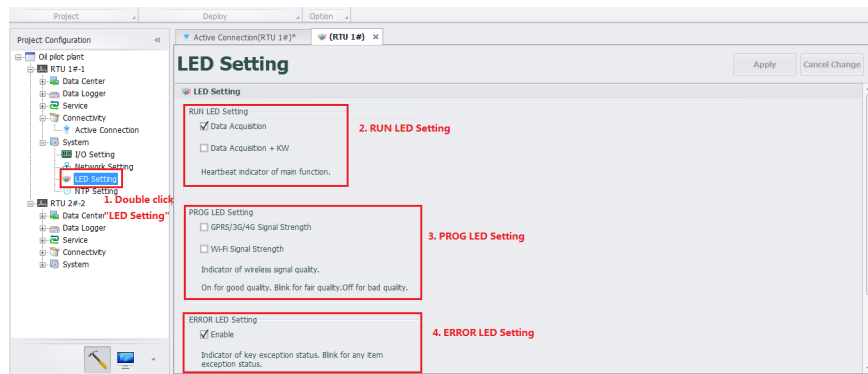

Figure 4.33 LED configuration

- **RUN Indicators Configuration**

ADAM-3600-C2G has two functions: data acquisition and control. When users only need data acquisition, just select “Data Collection” button. RUN indicator will blink if data acquisition function is normal. When users need data acquisition and control function, select “Data Collection + Softlogic”. RUN indicator will blink if both functions are normal. Otherwise, any function is abnormal, the RUN indicator won't blink.

- **PROG Indicator Configuration**

PROG indicator is for users programming, so in the initial condition PROG is not selected. When users want a LED indicator to display the signal of wireless communication connection, PROG indicator can be applied. The wireless signal includes GPRS/3G/4G signal and Wi-Fi signal. Users can select depends on different requirements. Long light means the signal is good, blinking means the signal is normal, and off means the signal is bad.

- **ERROR Indicator Configuration**

Users can also enable ERROR indicator to ensure the correctness of data recording and communication connection for ADAM-3600-C2G. When ERROR indicator blinks, it means at least one module among data recording, GPRS/3G/4G connection and Wi-Fi connection is wrong. The enabling of ERROR indicator can indicate important information and help users monitor the system.

4.3 Project Deployment

This section will introduce the steps to download the configured project to the related RTU devices. Users can one click to download the project to many RTU devices through the NodeID identification.

4.3.1 Device Identification

Before we start to download the configuration to the RTU device, users have to adjust the connected RTUs to be with the correct NodeID as project required.

The “Device Search” will help user to explore all the RTU devices which the NodeID is mentioned in the configured project. After the search, utility will feedback the IP address of the RTUs and show the status as “on-line”. If the NodeID setting is incorrect or the device is actually not in the network, the status will show “off-line”

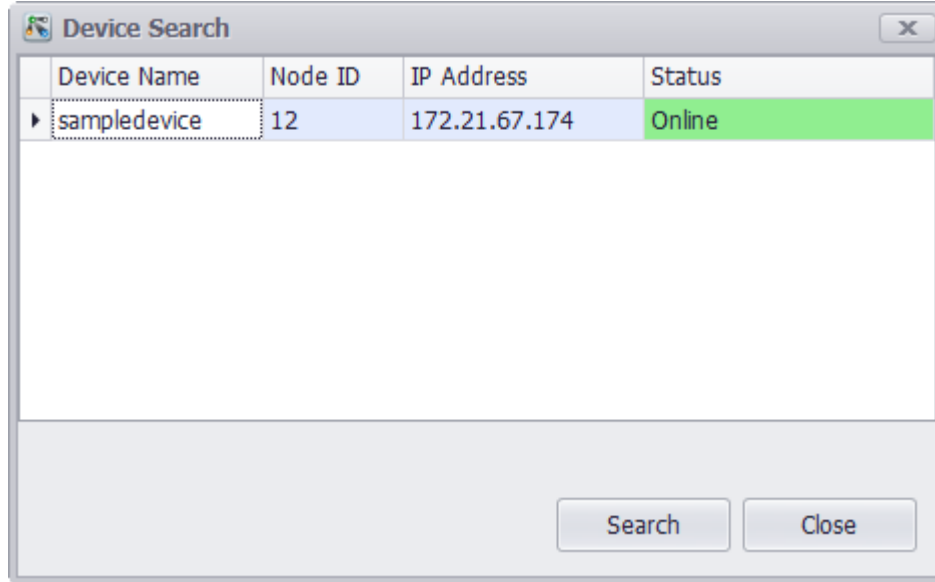

Figure 4.34 Identification for Connected RTU Devices

4.3.2 Project Download

While all the RTU devices are no-line, click “Project Download” to download the project into the RTU devices. If users click and active the project node on the left-hand-side tree view and click the “Project Download”, user can download the whole project to all the devices on line by one click. If users only click and activate one target device on the tree view, the “Project Download” will only download the project to the selected device.

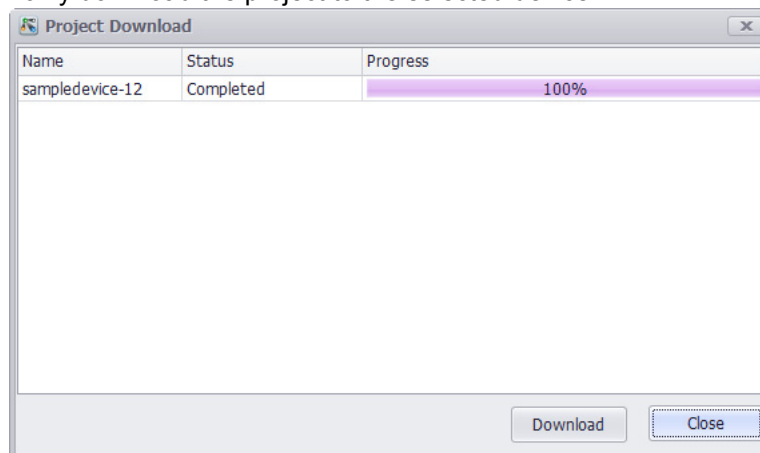

Figure 4.35 Project Download

4.3.3 Password Settings

For security, the ADAM-3600-C2G has a default password "00000000", and iRTU Studio also sets it as the default password for RTU devices.

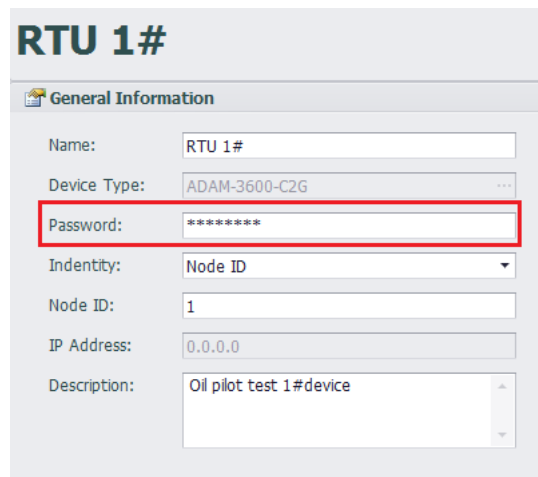

Figure 4.36 Password Information

To change the password, follow the steps below:

1. iRTU Studio connects with the RTU device, and it has been identified.
2. Click 'password setting', select the device, input the old and new password respectively and then confirm the new password.
3. Back to the General Information of the RTU device, edit 'password' to ensure it fit the new password. Please note the "Project download" will not work if the password does not match.

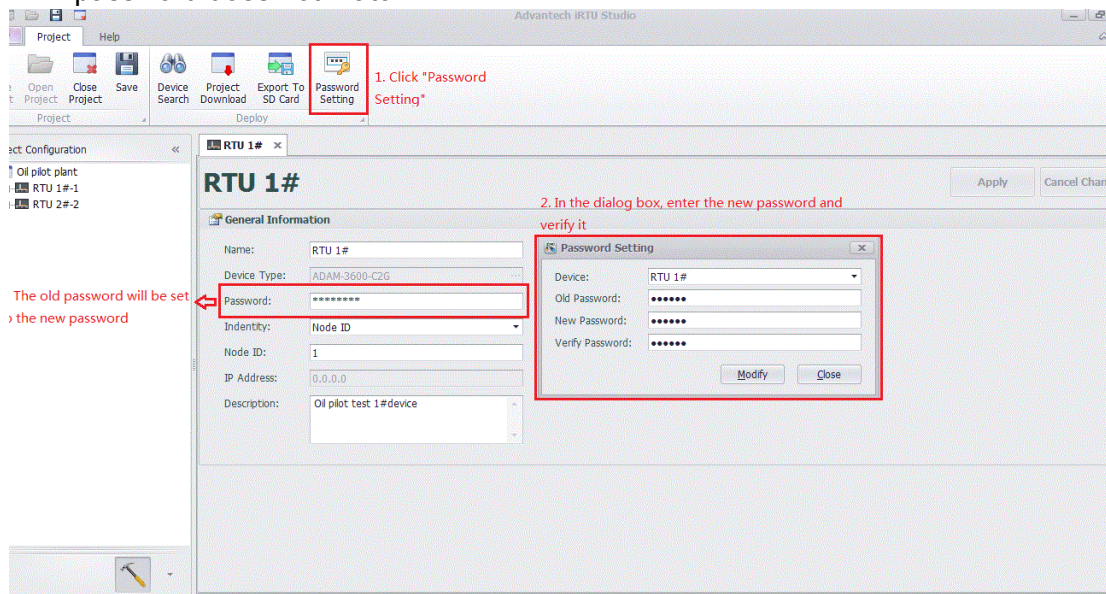

Figure 4.37 Password Settings

Appendix **A**

ADAM-3600 Naming
Rules

A.1 ADAM-3600 Naming Rules

The ADAM-3600 includes two types of products that are ADAM-3600-A1F and ADAM-3600-C2G, which shows a difference as far as their design and features. In this Manual, we focus on the introductions of ADAM-3600-C2G.

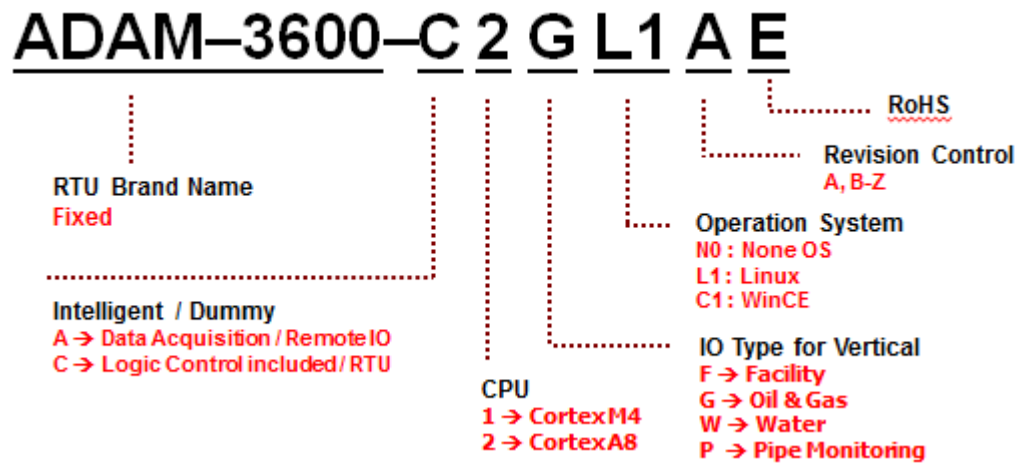

Figure A.1 ADAM-3600 Naming Rules

Examples:

ADAM-3600-C2GL1AE: Cortex A8 iRTU for Oil & Gas (C Series)

ADAM-3600-A1FN0AE: Cortex M4 Remote IO for Facility Monitoring (A Series)

Appendix **B**

Interface Definition

B.1 Interface Definitions

B.1.1 Communication Ports

B.1.1.1 COM 1: RS-232/RS-485

- Connection: DB-9
- Baud rate: 1200~115.2k bps
- RS232 signals: RxD, TxD, GND, RTS, CTS
- RS485 signals: DATA+, DATA-

PIN	RS-232 Signal
1	N/C
2	RXD
3	TXD
4	N/C
5	GND
6	N/C
7	RTS
8	CTS
9	N/C

PIN	RS-485 Signal
1	DATA-
2	DATA+
3	N/C
4	N/C

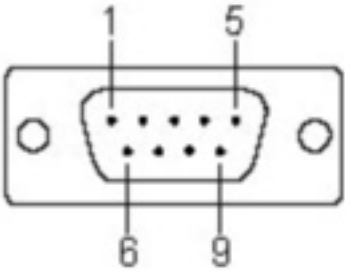

The diagram shows a DB-9 connector with a central row of nine pins. Pin 1 is the top-left pin, pin 5 is the top-right pin, pin 6 is the bottom-left pin, and pin 9 is the bottom-right pin. There are two circular mounting holes on either side of the connector housing.

B.1.1.2 COM 2 & COM3: RS-485

- Connection: Terminal Block
- Baud rate: 1200~921.6k bps
- RS-485 signals: DATA+, DATA-
- Communication Isolation: 2000V_{DC}

PIN	RS-485 Signal
1	DATA2+
2	DATA2-
3	DATA3+
4	DATA3-

B.1.1.3 USB Port

- Connection: USB 2.0 1800 connect
- USB signals: Vcc, Data-, Data+, GND

PIN	USB Signal
1	VCC
2	Data-
3	Data+
4	GND

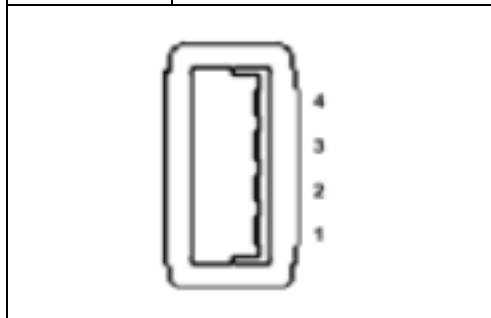
**B.1.1.4 LAN1 and LAN2: Ethernet Port**

- Connection: RJ-45 Base-T 1800 connect
- Transfer rate: 10/100Mbps
- LAN signals: TD+, TD-, RD+, RD-

PIN	Signal
1	TD+
2	TD-
3	RD+
4	N/C
5	N/C
6	RD-
7	N/C
8	N/C

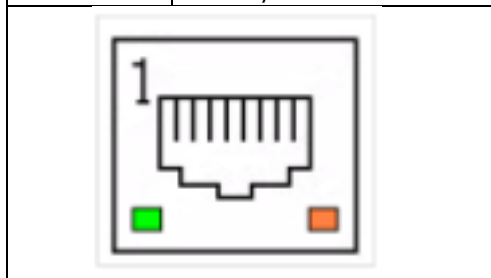

B.1.2 I/O Interface Definition

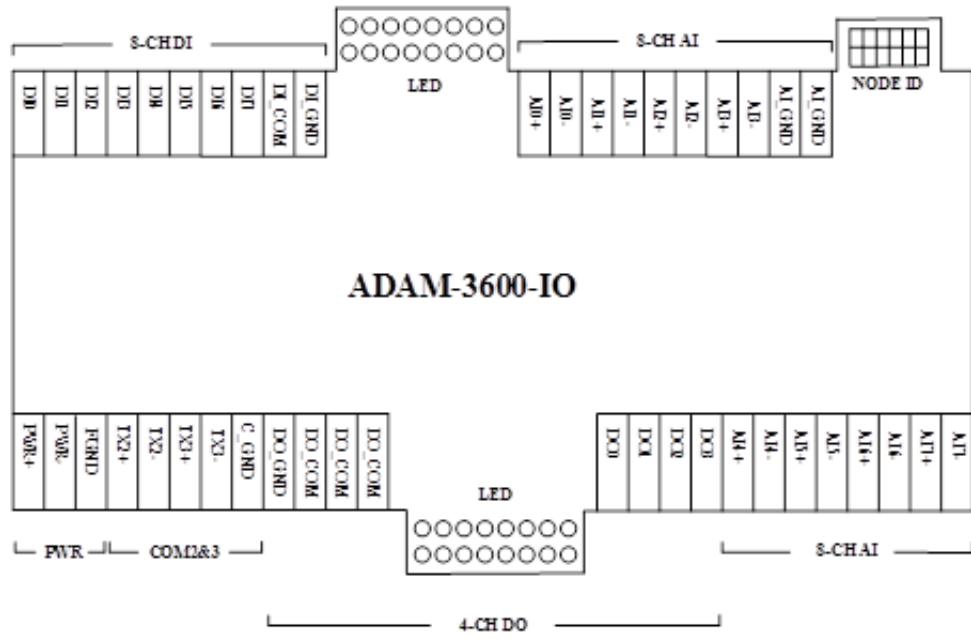

www.advantech.com

Please verify specifications before quoting. This guide is intended for reference purposes only.

All product specifications are subject to change without notice.

No part of this publication may be reproduced in any form or by any means, electronic, photocopying, recording or otherwise, without prior written permission of the publisher.

All brand and product names are trademarks or registered trademarks of their respective companies.

© Advantech Co., Ltd. 2015