

# **POS-562/562L**

Super Multimedia POS Board  
with SVGA, Ethernet, and Audio

User's Manual for POS-562/562L

## Copyright notice

This document is copyrighted, 1998. All rights are reserved. The original manufacturer reserves the right to make improvements to the products described in this manual at any time without notice.

No part of this manual may be reproduced, copied, translated or transmitted in any form or by any means without the prior written permission of the original manufacturer. Information provided in this manual is intended to be accurate and reliable. However, the original manufacturer assumes no responsibility for its use, nor for any infringements upon the rights of third parties which may result from its use.

## Acknowledgements

SiS is a trademark of Silicon Integration Systems Corp.

AMD is a trademark of Advanced Micro Devices, Inc.

Award is a trademark of Award Software International, Inc.

Cyrix is a trademark of Cyrix Corporation.

IBM, PC/AT, PS/2 and VGA are trademarks of International Business Machines Corporation.

Intel and Pentium are trademarks of Intel Corporation.

Microsoft Windows® is a registered trademark of Microsoft Corp.

SMC is a trademark of Standard Microsystems Corporation.

C&T is a trademark of Chips and Technologies, Inc.

UMC is a trademark of United Microelectronics Corporation.

RTL is a trademark of Realtek Semi-Conductor Co., Ltd.

All other product names or trademarks are properties of their respective owners.

Part No. 2007056200

Printed in Taiwan

1st Edition

July 1998

## Packing List

---

Before installing your board, insure that the following materials have been received:

- 1 POS-562/562L all-in-one single board computer
- 1 Ethernet driver disk
- 2 utility disks with PCI SVGA utility programs and drivers for Windows 3.1/95/NT
- 1 audio driver for Windows 3.1/95 and DOS utility program (POS-562 only)
- 1 Audio cable (POS-562 only)
- 1 warranty certificate
- 1 FDD cable
- 1 HDD cable
- 2 serial port cables

If any of these items are missing or damaged, contact your distributor or sales representative immediately.

# Table of Contents

<b>Chapter 1</b>	<b>General Information</b>	<b>1</b>
1.1	Introduction	2
1.2	Features	3
1.3	Specifications	3
	Standard SBC functions	3
	Audio function (POS-562 only)	4
	PCI high performance CRT/flat panel interface	5
	LVDS (Low Voltage Differential Signal) interface	5
	Ethernet interface	5
	Solid state disk	5
	Mechanical and environmental	5
1.4	Features Layout and Dimensions	6
<b>Chapter 2</b>	<b>Installation</b>	<b>7</b>
2.1	Jumpers	8
2.2	Connectors	9
2.3	Locating Jumpers and Connectors	11
2.4	Setting Jumpers	12
2.5	CPU Installation and Upgrading	13
	Install a CPU in the ZIF socket	13
	System clock setting (JP19, JP22 and JP23)	14
	PCI clock setting (JP22)	14
	CPU frequency ratio (JP19)	15
	System/PCI clock setting (JP22,JP23)	15
	Pentium®/Pentium® MMX single/dual voltage CPU select (JP16)	16
	CPU voltage setting (JP11)	16
	M1 cache linear mode setting (JP25)	17
	CMOS clear (JP14)	18
	Buzzer enable/disable (JP26)	18
2.6	DRAM Installation	18
	SIMM DRAM (SIM 1 and SIM 2)	18
	DIMM DRAM (DIM 1)	18

<b>2.7</b>	<b>40-pin Primary IDE (3.5" HDD) Connector (CN16)</b> .....	<b>19</b>
	Connecting the hard drive .....	19
<b>2.8</b>	<b>44-pin Secondary Mini-pitched IDE Interface (2.5" HDD) (CN13)</b> .....	<b>19</b>
<b>2.9</b>	<b>Floppy Drive Connector (CN12)</b> .....	<b>20</b>
	Connecting the floppy drive .....	20
<b>2.10</b>	<b>Primary Parallel Port Connector (LPT1: CN23)</b> .....	<b>21</b>
<b>2.11</b>	<b>Secondary Parallel Port (LPT2: CN21)</b> .....	<b>21</b>
<b>2.12</b>	<b>Keyboard Connector (CN1, CN7, CN9)</b> .....	<b>21</b>
<b>2.13</b>	<b>Power Connectors (CN2, CN8, CN27)</b> .....	<b>22</b>
	Main power connector (CN2) .....	22
	ATX power input connector (CN8) .....	22
	Fan power supply connector (CN27) .....	22
	ATX power control switch (CN14) .....	22
<b>2.14</b>	<b>Audio Interfaces (CN5, CN6)</b> .....	<b>23</b>
	Audio connector (CN5) .....	23
	CD audio input connector (CN6) .....	23
<b>2.15</b>	<b>Serial Ports (COM1 - 4) (CN15, CN17, CN18, CN19, CN20, CN22)</b> .....	<b>24</b>
	Primary serial ports (COM1: CN19/CN22, COM2: CN17/CN20) .....	24
	Secondary serial ports (COM3: CN18, COM4: CN15) .....	24
<b>2.16</b>	<b>COM2 RS-232/422/485 Selection (JP15, JP17 and JP18)</b> .....	<b>25</b>
	COM1 - COM4 IRQ and I/O ports .....	25
	COM1 - COM4 RI pin +5/+12 V power setting (JP6, JP8, JP9, JP12) .....	26
<b>2.17</b>	<b>VGA Interface Connections</b> .....	<b>27</b>
	CRT display connector (CN30 and CN31) .....	27
	Flat panel display connector (CN29, CN28) .....	27
	LCD power setting (JP21) .....	28
<b>2.18</b>	<b>LVDS Interface (CN26)</b> .....	<b>28</b>
<b>2.19</b>	<b>Ethernet Configuration</b> .....	<b>29</b>
	RJ-45 connector (CN11) .....	29
	Network boot .....	29
<b>2.20</b>	<b>Watchdog Timer Configuration</b> .....	<b>29</b>
	Watchdog timer action (JP7) .....	29
<b>2.21</b>	<b>USB Connector (CN33)</b> .....	<b>30</b>
<b>2.22</b>	<b>IR Connector (CN25)</b> .....	<b>30</b>
<b>2.23</b>	<b>DOC® 2000 Address Setting (JP4)</b> .....	<b>31</b>

## **Chapter 3 Software Configuration.....33**

<b>3.1 Introduction .....</b>	<b>34</b>
<b>3.2 VGA Display Firmware Configuration .....</b>	<b>34</b>
<b>3.3 Connections for Four Standard LCDs .....</b>	<b>36</b>
Connections to Sharp LM64183P (640 x 480 DSTN MONO LCD) .....	36
Connections to PLANAR EL (640 x 480 AD4 EL) .....	37
Connections to Toshiba LTM10C042 (640 x 480 TFT color LCD) .....	38
Connections to Sharp LM64C142 (640 x 480 DSTN color LCD) .....	39
<b>3.4 Ethernet Software Configuration .....</b>	<b>40</b>

## **Chapter 4 Award BIOS Setup.....41**

<b>4.1 System Test and Initialization .....</b>	<b>42</b>
System configuration verification .....	42
<b>4.2 AWARD BIOS Setup.....</b>	<b>43</b>
Entering setup .....	43
Standard CMOS setup .....	44
BIOS features setup .....	45
CHIPSET features setup .....	46
Power management setup.....	47
PnP/PCI configuration setup .....	48
Integrated peripherals .....	49
Load BIOS defaults.....	50
Change password .....	51
Auto detect hard disk .....	52
Save & exit setup .....	52
Exit without saving .....	52

## **Chapter 5 PCI SVGA Setup .....53**

<b>5.1 Before You Begin .....</b>	<b>54</b>
<b>5.2 Installation .....</b>	<b>54</b>
<b>5.3 Simultaneous Display Mode .....</b>	<b>55</b>
<b>5.4 Sleep Mode .....</b>	<b>55</b>
<b>5.5 Driver Installation .....</b>	<b>56</b>
Windows setup .....	57
DOS setup .....	58

<b>5.6</b>	<b>Windows 95 Drivers Setup Procedure .....</b>	<b>59</b>
<b>5.7</b>	<b>Windows NT Drivers Setup Procedure .....</b>	<b>60</b>
<b>5.8</b>	<b>OS/2 Drivers Setup Procedure .....</b>	<b>61</b>
	Preliminary steps .....	61
	Installing from diskette .....	61
	Selecting monitor type .....	63
	Selecting screen resolution/refresh rate .....	63
	Installation notes .....	64

## **Chapter 6 Audio Setup ..... 65**

<b>6.1</b>	<b>Introduction .....</b>	<b>66</b>
<b>6.2</b>	<b>DOS Utilities .....</b>	<b>66</b>
<b>6.3</b>	<b>Driver Installation .....</b>	<b>68</b>
	Before you begin .....	68
	Windows 3.1 drivers .....	68
	Windows 95 drivers .....	69

## **Appendix A Programming the Watchdog Timer ..... 71**

<b>A.1</b>	<b>Programming the Watchdog Timer .....</b>	<b>72</b>
------------	---	-----------

## **Appendix B Pin Assignments ..... 73**

CRT display connector (CN30) .....	74
Flat panel display connector (CN29) .....	75
Flat panel display connector extension (CN28) .....	76
LVDS interface connector (CN26) .....	76
Universal serial bus (USB) connector (CN33) .....	77
Fan power connector (CN27) .....	77
LAN LED connector (CN10) .....	77
HDD LED connector (CN4) .....	78
Speaker connector (CN32) .....	78
CD audio in connector (CN6) .....	78
ATX power connector (CN8) .....	79
ATX power control switch (CN14) .....	79
Ethernet RJ-45 connector (CN11) .....	79
Audio connector (CN5) .....	80
IR connector (CN25) .....	80
PS/2 keyboard connector (CN1) .....	81
Main power connector (CN2) .....	81

PS/2 mouse connector (CN9) .....	82
COM2 RS-232/422/485 serial port connectors (CN17, CN20) ...	82
COM1, COM3, COM4 RS-232 connections (COM1: CN19/CN22, COM3: CN18, COM4: CN15) .....	83
IDE hard drive connector (CN16, CN13) .....	89
Floppy drive connector (CN12) .....	90
Parallel port connectors (CN21, CN23) .....	91
System I/O ports .....	92
1st MB memory map .....	93
DMA channel assignments .....	93
IRQ mapping chart .....	94

## **Appendix C DOC® 2000 Installation Guide.....95**

<b>DiskOnChip® 2000 Quick Installation Guide .....</b>	<b>96</b>
DiskOnChip® 2000 installation instructions .....	96
Additional information and assistance .....	97

# Tables

Table 2-1: POS-562/562L jumpers .....	8
Table 2-2: POS-562/562L connectors .....	9
Table 2-2: POS-562/562L connectors (cont.) .....	10
Table 2-3: CPU speed reference table .....	14
Table 2-4: PCI clock setting (JP22) .....	14
Table 2-5: CPU frequency ratio (for Intel processor) (JP19) .....	15
Table 2-6: CPU frequency ratio (for AMD K6 processor) (JP19) .....	15
Table 2-7: System/PCI clock setting (JP23) .....	15
Table 2-8: Pentium®/Pentium® MMX single/dual voltage CPU select (JP16) .....	16
Table 2-9: CPU voltage setting (JP11) .....	16
Table 2-10: M1 cache linear mode setting (JP25) .....	17
Table 2-11: CMOS clear (JP14) .....	18
Table 2-12: Buzzer enable/disable (JP26) .....	18
Table 2-13: PS/2 keyboard/mouse selection (CN9) (JP2, JP3) .....	21
Table 2-14: ATX/PS/2 power input selection (JP13) for CN8 .....	22
Table 2-15: RS-232/422/485 selection jumper settings .....	25
Table 2-16: POS-562/562L serial port default settings .....	25
Table 2-17: COM1 RI pin setting .....	26
Table 2-18: COM2 RI pin setting .....	26
Table 2-19: COM3 RI pin setting .....	26
Table 2-20: COM4 RI pin setting .....	26
Table 2-21: LCD power setting (JP21) .....	28
Table 2-22: LCD SHFCLK polarity setting (JP20) .....	28
Table 2-23: Watchdog timer action (JP7) .....	30
Table 2-24: DOC® 2000 addresssss setting (JP4) .....	31
Table 3-1: POS-562/562L connection for Sharp LM64P83 LCD(CN12) .....	36
Table 3-2: POS-562/562L connection for PLANAR EL LCD (CN12) .....	37
Table 3-2: POS-562/562L connection for Toshiba LTM10C042 LCD (CN12) .....	38
Table 3-3: POS-560 connection for Sharp LM64C142 LCD (CN12) .....	39
Table B-1: POS-562/562L internal CRT VGA connector (CN31) .....	74
Table B-2: POS-562/562L CRT VGA connector (CN30) .....	74

Table B-3: POS-562/562L flat panel display connector (CN29) .....	75
Table B-4: POS-562/562L flat panel display connector extension (CN28) .....	76
Table B-5: POS-562/562L LVDS interface connector (CN26) .....	76
Table B-6: POS-562/562L universal serial bus (USB) connector (CN33) .....	77
Table B-7: POS-562/562L fan power connector (CN27) .....	77
Table B-8: POS-562/562L LAN LED (CN10) .....	77
Table B-9: POS-562/562L HDD LED connector (CN4) .....	78
Table B-10: POS-562/562L speaker connector (CN32) .....	78
Table B-11: POS-562/562L CD audio in connector (CN6) .....	78
Table B-12: POS-562/562L ATX power connector (CN8) .....	79
Table B-13: POS-562/562L ATX power control switch (CN14) ..	79
Table B-14: POS-562/562L Ethernet RJ-45 connector (CN11) ..	79
Table B-16: POS-562/562L audio connector (CN5) .....	80
Table B-15: POS-562/562L IR connector (CN25) .....	80
Table B-18: POS-562/562L PS/2 keyboard connector (CN1) ...	81
Table B-17: POS-562/562L main power connector (CN2) .....	81
Table B-19: POS-562/562L PS/2 mouse connector (CN9) .....	82
Table B-20: POS-562/562L COM2 RS-232/422/485 serial port (CN17, CN20) .....	82
Table B-22: POS-562/562L PCI/ISA slot pin assignments (pins A and B) .....	85
Table B-23: POS-562/562L PCI/ISA slot pin assignments (pins C and D) .....	86
Table B-24: POS-562/562L PCI/ISA slot pin assignments (pins E and F) .....	87
Table B-25: POS-562/562L PCI/ISA slot pin assignments (pins G and H) .....	88
Table B-26: POS-562/562L IDE hard drive connector (CN16, CN13) .....	89
Table B-27: POS-562/562L floppy drive connector (CN12) .....	90
Table B-28: POS-562/562L parallel port connector (CN21, CN23) .....	91
Table B-29: POS-562/562L system I/O ports .....	92
Table B-30: POS-562/562L 1st MB memory map .....	93
Table B-31: POS-562/562L DMA channel assignments .....	93
Table B-32: POS-562/562L IRQ mapping chart .....	94

# Figures

Figure 1-1: POS-562/562L board configuration .....	6
Figure 2-1: POS-562/562L jumpers and connectors .....	11
Figure 3-1: VGA setup screen .....	35
Figure 4-1: Setup program initial screen .....	43
Figure 4-2: CMOS setup screen .....	44
Figure 4-3: BIOS features setup screen .....	46
Figure 4-5: Power management setup screen .....	47
Figure 4-6: PCI configuration setup screen .....	48
Figure 4-7: Integrated peripherals setup screen .....	49
Figure 4-4: CHIPSET features setup screen .....	50
Figure 4-8: Load BIOS defaults screen .....	51
Figure 4-9: IDE HDD auto detection screen .....	52



# CHAPTER 1

## General Information

This chapter gives background information on the POS-562/562L.

Sections include:

- Introduction
- Features
- Specifications
- Board layout and dimensions

## 1.1 Introduction

---

The POS-562/562L is a powerful Pentium® processor-based control board designed for high-end multimedia POS applications as well as other special OEM markets. It supports Intel Pentium® P54C, P55C (MMX), AMD K5 and K6, IDT C6 and Cyrix 6x86MX processors. The POS-562/562L is packed with special on-board features like 100/10Base-T Ethernet, 16-bit sound, 36-bit XGA LCD and LVDS support as well as DOC 2000 and an abundance of IOs.

The POS-562/562L uses a standardized layout based on Western Digital's LPM/LPX format. It is 100% PC compatible and readily connectable to any existing PC hardware and software. Special POS features like four on-board serial ports, each with +5 V/+12 V power output capability, and two USB connections are available to accommodate a wide array of POS peripherals.

POS-562/562L's industrial grade construction allows it to withstand continuous operation in a harsh POS environment where reliability is essential. Other on-board industrial features not found on conventional motherboards include a watchdog timer for dependability during unmanned operations, and CMOS backup to Flash ROM. An on-board SSD socket can support DiskOnChip® Flash modules.

The POS-562/562L includes two 72-pin SIMM sockets (maximum 128 MB DRAM) and one 168-pin DIMM socket for up to 128 MB total on-board memory.

## 1.2 Features

---

- All-in-one design simplifies system integration and increases system stability
- Compatible with Intel Pentium® and Pentium MMX, Cyrix 6x86 MX, AMD K5 and K6, and IDT C6 processors up to 233 MHz
- On-board POS features such as 4 x RS-232 with power and 2 x USB interfaces for controlling cash drawers or other external peripherals
- 100/10Base-T with RJ-45 connection for the most demanding networking environment
- 16-bit full-duplex 3D audio for quality multimedia sound applications (POS-562 only)
- Special industrial features not found on conventional motherboards include watchdog timer, SSD and CMOS EPROM backup
- Standardized layout conforms to Western Digital LPM/LPX format for easy installation within standard sized chassis
- Supports up to 36-bit XGA high resolution LCD, 18-bit LVDS, as well as CRT VGA at 2 ~ 4 MB display memory
- Advanced CPU switching power technology for stable and low heat CPU voltage power conversion
- Supports DiskOnChip® Flash modules

## 1.3 Specifications

---

### Standard SBC functions

- **Processor:** Intel Pentium®, Pentium MMX up to 233 MHz  
AMD K5, K6, Cyrix 6x86 MX, IDT C6
- **BIOS:** Award 256 KB Flash BIOS includes Ethernet boot ROM and VGA BIOS. Supports Plug and Play
- **System chipset:** SiS 5582
- **Green function:** APM 1.1 compliant

- **Second level cache:** On-board 512 KB Pipelined Burst SRAM
- **RAM:** Two 72-pin SIMM sockets and one 168-pin DIMM socket for 128 MB total on-board memory.
- **Enhanced IDE interface:** Two Enhanced IDE interfaces, one 44-pin header for 2.5" HDD and one 40-pin header supports 3.5" HDD&CD-ROM
- **FDD interface:** Supports up to two FDDs (360 KB/1.2 MB/720 KB/1.44 MB/2.88 MB)
- **Parallel port:** Two parallel ports, supporting SPP/EPP/ECP parallel mode
- **Serial port:** Four serial ports with +5 V/+12 V power capability  
COM 1, 3, 4: RS-232  
COM 2: RS-232/422/485
- **Watchdog timer:** Software enabled/disabled. 0 ~ 63 sec. selectable
- **Keyboard connector:** Mini-DIN keyboard connector and internal 6-pin header connector for mouse/keyboard
- **Mouse connector:** PS/2 mouse connector, jumper selectable to keyboard
- **USB interface:** Two USB connectors with fuse protection. Complies with USB Spec. Rev. 1.0
- **Power inputs:** ATX power connection (conforms to ATX power supply specification), AT power connection
- **Expansion bus:** PISA bus (PCI/ISA). Expand via riser card (POS-102)

### **Audio function (POS-562 only)**

- **Chipset:** ESS 1869
- **Audio controller:** 16-bit, Sound Blaster Pro compatible
- **Sound quality:** Full-duplex, integrated 3D audio
- **Audio interface:** Mic in, Line in, CD audio in, Line out, Speaker out

## **PCI high performance CRT/flat panel interface**

- **Chipset:** C&T 65555 (C&T 69000), 64-bit graphics engine
- **Flat panel performance:** 36-bit direct interface to mono, STN, DSTN & TFT panels. Advanced power management. 3.3 volt LCD supported
- **CRT/LCD Resolution:** Up to 1280 x 1024 x 16 bpp @ 4 MB DRAM
- **Display Memory:** 2 MB on-board standard, 4 MB optional

## **LVDS (Low Voltage Differential Signal) interface**

- **Chipset:** TISN75LVDS84
- **Performance:** 18 low-voltage TTL data channels plus clock-in and 3 low-voltage differential data channels plus clock-out. 3.3 volt and 250 mW (typ.). Meets ANSI EIA/TIA-644

## **Ethernet interface**

- **Chipset:** Realtek RTL 8139
- **Ethernet interface:** PCI 100/10 Mbps Ethernet controller. Includes software drivers and boot ROM (RJ-45 connection)

## **Solid state disk**

- One 32-pin socket supports DiskOnChip®, upto 72 MB
- DOS ,Windows 3.1, Windows 95 and Windows NT command compatible

## **Mechanical and environmental**

- **Max. power requirements:** 7 A @ 5 V (4.75 to 5.25), 0.15 A @  $\pm 12$  V
- **Operating temperature:** 0 to 60° C (32 to 140° F)
- **Size:** 220 mm (L) x 235 mm (W) (8.7" x 9.25")
- **Weight:** 0.5 kg (1.1 lbs.)

**Note:** Specifications subject to change without notice.

## 1.4 Features Layout and Dimensions

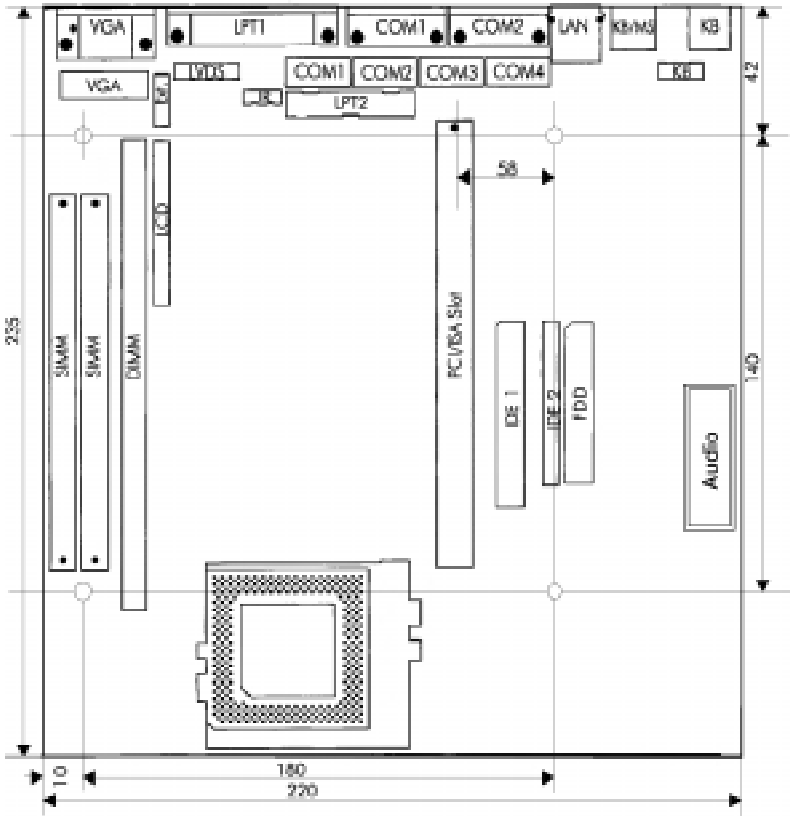

**WD/LPM/LPX Format**  
**Overall Size: 220 mm x 235 mm**  
**All units in mm**

*Figure 1-1: POS-562/562L board configuration*

# CHAPTER 2

## Installation

This chapter explains how to set up the POS-562/562L hardware, including instructions on setting jumpers and connecting peripherals, switches and indicators. Be sure to read all the safety precautions before you begin the installation procedure.

## 2.1 Jumpers

---

The POS-562/562L has a number of jumpers that allow you to configure your system to suit your application. The table below lists the function of each of the board's jumpers.

---

Table 2-1: POS-562/562L jumpers

---

Label	Function
JP1	IR keyboard address (reserved for OEM customer)
JP2	CN9 mouse/keyboard select
JP3	CN9 mouse/keyboard select
JP4	DOC®2000 address select
JP5	Reserved
JP6	COM4 RI power selection
JP7	Watchdog timer action
JP8	COM3 RI power selection
JP9	COM2 RI power selection
JP10	Reserved
JP11	CPU voltage selection
JP12	COM1 RI power selection
JP13	ATX/AT power input selection
JP14	CMOS clear
JP15	COM2 RS-232/422/485 setting
JP16	CPU single/dual voltage select
JP17	COM2 RS-232/422/485 setting
JP18	COM2 RS-232/422/485 setting
JP19	CPU frequency ratio setting
JP20	LCD SHFCLK polarity
JP21	LCD power setting
JP22	PCI clock setting

---

JP23	System/PCI clock setting
JP24	System reset
JP25	Cyrix M1 CPU L2 cache (Linear access mode)
JP26	Buzzer enabled/disabled
JP27	Reserved
JP28	Reserved
JP29	Reserved

## 2.2 Connectors

On-board connectors link the POS-562/562L to external devices such as hard disk drives, a keyboard, or floppy drives. The tables below lists the function of each of the board's connectors.

Table 2-2: POS-562/562L connectors

Label	Function
CN1	PS/2 keyboard connector
CN2	Main power connector
CN3	IR KB (for OEM customers) connector
CN4	HDD LED
CN5	Audio connector
CN6	CD audio in connector
CN7	Internal KB connector
CN8	ATX power connector
CN9	PS/2 mouse/KB connector
CN10	LAN LED connector
CN11	Ethernet connector
CN12	FDD connector
CN13	Secondary IDE (for 2.5") connector
CN14	ATX power control switch
CN15	Internal COM4 connector

---

Table 2-2: POS-562/562L connectors (cont.)

---

<b>Label</b>	<b>Function</b>
CN16	Primary 3.5" IDE connector
CN17	COM2 connector
CN18	Internal COM3
CN19	COM1 connector
CN20	Internal COM2 connector
CN21	LPT2 connector
CN22	Internal COM1 connector
CN23	LPT1 connector
CN24	Backlight control (reserved)
CN25	IR connector
CN26	LVDS interface connector
CN27	Fan power connector
CN28	Flat panel display connector (extension)
CN29	Flat panel display connector
CN30	CRT display connector
CN31	Internal CRT display connector
CN32	Speaker connector
CN33	USB connector

---

## 2.3 Locating Jumpers and Connectors

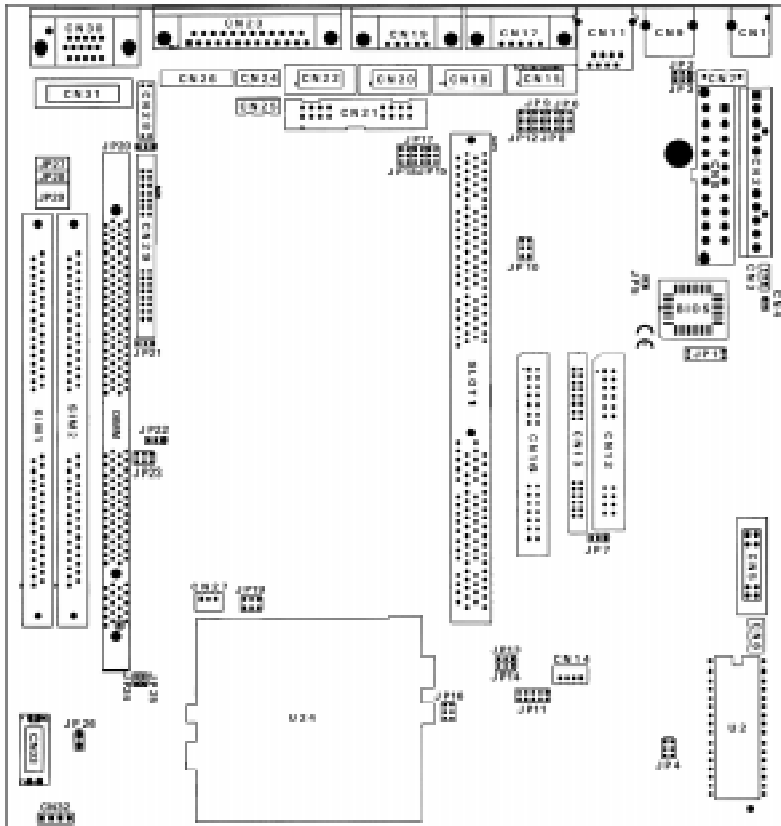
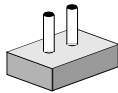

Figure 2-1: POS-562/562L jumpers and connectors

## 2.4 Setting Jumpers

---

You configure your board to match the needs of your application by setting jumpers. A jumper is the simplest kind of electric switch. It consists of two metal pins and a small metal clip (often protected by a plastic cover) that slides over the pins to connect them. To “close” a jumper you connect the pins with the clip. To “open” a jumper you remove the clip. Sometimes a jumper will have three pins, labeled 1, 2, and 3. In this case you would connect either pins 1 and 2 or 2 and 3.



*Open*

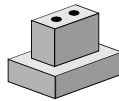

*Closed*

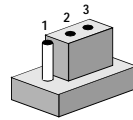

*Closed 2-3*

The jumper settings are schematically depicted in this manual as follows:



*Open*



*Closed*

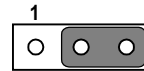

*Closed 2-3*

A pair of needle-nose pliers may be helpful when working with jumpers.

If you have any doubts about the best hardware configuration for your application, contact your local distributor or sales representative before you make any changes.

Generally, you simply need a standard cable to make most connections.

## 2.5 CPU Installation and Upgrading

---

You can upgrade to a higher power Pentium® processor at any time. Simply remove the old CPU, install the new one, and set the jumpers for the new CPU type and speed.

**Warning!** *Always disconnect the power cord from your chassis before you begin working on it. Do not make connections while the power is on because sensitive electronic components can be damaged by the sudden rush of power. Only experienced electronics personnel should open the PC chassis.*



**Caution!** *Always ground yourself to remove any static charge before touching the CPU board. Modern electronic devices are very sensitive to static electric charges. Use a grounding wrist strap at all times. Place all electronic components on a static-dissipative surface or in a static-shielded bag when they are not in the chassis.*



### Install a CPU in the ZIF socket

POS-562/562L provides a Zero Insertion Force (ZIF) socket for easy CPU installation.

1. Make sure the ZIF socket lever is in the upright position. To raise the lever, pull it out to the side a little and raise it as far as it will go.
2. Place the CPU in the empty socket. Follow the instructions that came with the CPU. If you have no instructions, do the following: Carefully align the CPU so it is parallel to the socket and the notch on the corner of the CPU corresponds with the notch on the inside of the socket. Gently slide the CPU in. It should insert easily. If it doesn't, pull the lever up a little more.

- Press the lever down. The plate will slide forward. You will feel some resistance as the pressure starts to secure the CPU in the socket. This is normal and won't damage the CPU.

When the CPU is installed, the lever should snap into place at the side of the socket.

**Note:** *To remove a CPU, pull the lever out to the side a little and raise it as far as it will go. Lift out the CPU chip.*

When you install a new CPU, be sure to adjust the board settings, such as CPU type and CPU clock. **Improper settings may damage the CPU.**

### System clock setting (JP19, JP22 and JP23)

JP19, JP22 and JP23 are used to set the CPU and PCI bus speed to optimize the system performance. The system chipset will sense the JP19 setting to get the bus frequency, then adjust its internal timing. JP22 is used to set the CPU and PCI clock. JP23 is P55C enable/disable and CPU clock ratio setting jumper. Refer to the CPU Speed Reference Table (below) for instructions on adjusting the internal clocks according to the base CPU speed.

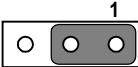

Table 2-3: CPU speed reference table

CPU speed (MHz)	75	100	*133	150	166	200	233	266	300
Sys. clock setting	50	66	66	60	66	66	66	66	66
Frequency ratio	1.5	1.5	2	2.5	2.5	3	3.5	4	4.5

\* default setting

### PCI clock setting (JP22)

Table 2-4: PCI clock setting (JP22)

CPU (system) CLK/2	* 33 MHz (fixed)
	

\* default setting

## CPU frequency ratio (JP19)

Table 2-5: CPU frequency ratio (for Intel processor) (JP19)

PentiumMMX	3.5	2	2.5	3
Pentium	1.5	2*	2.5	3

5 3 1	5 3 1	5 3 1	5 3 1
6 4 2	6 4 2	6 4 2	6 4 2

\* default setting

Table 2-6: CPU frequency ratio (for AMD K6 processor) (JP19)

2	2.5	3	3.5/1.5	4
5 3 1	5 3 1	5 3 1	5 3 1	5 3 1
6 4 2	6 4 2	6 4 2	6 4 2	6 4 2
4.5	5 (Reserve)	5.5 (Reserve)		
5 3 1	5 3 1	5 3 1		
6 4 2	6 4 2	6 4 2		

Note: If Cyrix M1, M11 and IDT Winchip C6, Winchip II processors support a 60-66 MHz system bus then use the Intel® Pentium® jumper settings.

Table 2-7: System/PCI clock setting (JP23)

System clock (MHz)	50	60	66*
PCI clock (MHz)	25	30	33







  

	5 3 1	5 3 1	5 3 1
JP23			
	6 4 2	6 4 2	6 4 2
JP22			
	1	1	1

\* default setting

## Pentium®/Pentium® MMX single/dual voltage CPU select (JP16)

Table 2-8: Pentium®/Pentium® MMX single/dual voltage CPU select (JP16)

Pentium MMX enabled			*Pentium enabled		
1		2	1		2
3		4	3		4
5		6	5		6

**\*default setting**

*Note:* Pentium® processors include: Intel® Pentium, AMD-K5, Cyrix MI, IDT Winchip C6.

*Note:* Pentium® MMX processors include: Intel® PentiumMMX, AMD-K6, Cyrix MII, IDT Winchip II.

## CPU voltage setting (JP11)

JP11 must be set to match the CPU type. The chart below shows the proper jumper settings for their respective  $V_{CC(CORE)}$ . (The  $V_{CC(I/O)}$  for CPU is fixed to be 3.3 V).

Table 2-9: CPU voltage setting (JP11)

$V_{CC(CORE)}$	1 - 2	3 - 4	5 - 6	7 - 8	9 - 10
1.30 V	closed	open	open	open	open
1.35 V	closed	open	open	open	closed
1.40 V	closed	open	open	closed	open
1.45 V	closed	open	open	closed	closed
1.50 V	closed	open	closed	open	open
1.55 V	closed	open	closed	open	closed
1.60 V	closed	open	closed	closed	open
1.65 V	closed	open	closed	closed	closed
1.70 V	closed	closed	open	open	open
1.75 V	closed	closed	open	open	closed
1.80 V	closed	closed	open	closed	open
1.85 V	closed	closed	open	closed	closed

Table 2-9: CPU voltage setting (JP11) (cont.)



$V_{CC(CORE)}$	1 - 2	3 - 4	5 - 6	7 - 8	9 - 10
1.90 V	closed	closed	closed	open	open
1.95 V	closed	closed	closed	open	closed
2.00 V	closed	closed	closed	closed	open
2.05 V	closed	closed	closed	closed	closed
NONE	open	open	open	open	open
2.10 V	open	open	open	open	closed
2.20 V	open	open	open	closed	open
2.30 V	open	open	open	closed	closed
2.40 V	open	open	closed	open	open
2.50 V	open	open	closed	open	closed
2.60 V	open	open	closed	closed	open
2.70 V	open	open	closed	closed	closed
2.80 V	open	closed	open	open	open
2.90 V	open	closed	open	open	closed
3.00 V	open	closed	open	closed	open
3.10 V	open	closed	open	closed	closed
3.20 V	open	closed	closed	open	open
3.30 V*	open	closed	closed	open	closed
3.40 V	open	closed	closed	closed	open
3.50 V	open	closed	closed	closed	closed

\* default setting

## M1 cache linear mode setting (JP25)

POS-562/562L supports Cyrix M1 CPU with its linear access mode on L2 cache. This mode is set through JP25.

Table 2-10: M1 cache linear mode setting (JP25)

	Enabled	*Disabled
JP25		

\* default setting

## CMOS clear (JP14)

*Warning: To avoid damaging the computer, always turn off the power supply before setting "Clear CMOS." Set the jumper back to "Battery On" before turning on the power supply.*

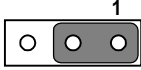
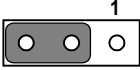

Table 2-11: CMOS clear (JP14)

	*Battery On	Clear CMOS
JP14		

\* default setting

## Buzzer enable/disable (JP26)

Table 2-12: Buzzer enable/disable (JP26)

	*Enabled	Disabled
JP26		

\* default setting

## 2.6 DRAM Installation

There are two on-board 72-pin SIMM sockets and one on-board 168-pin DIMM socket. You can use either SIMM or DIMM type DRAM, they **can not** be used simultaneously.

### SIMM DRAM (SIM 1 and SIM 2)

You can install up to 64 MB of SIMM DRAM on each socket for a total of 128 MB DRAM with two sockets filled. However, DRAM size and type must match when installing two SIMMs in each socket.

### DIMM DRAM (DIM 1)

You can also install one 168-pin DIMM (up to 128 MB DRAM) in

the DIMM socket. The POS-562/562L can operate with only DIMM DRAM installed.

*Caution:* When installing SIMM or DIMM, make sure the module is oriented properly. Do not use excess force during installation.

## 2.7 40-pin Primary IDE (3.5" HDD) Connector (CN16)

---

The 40-pin IDE connector supports up to two 40-pin IDE interface devices, including CD-ROM drives, tape-backup drives, HDDs, etc. When connecting, make sure pin 1 of the connector is matched with pin of the device's connector.

The built-in Enhanced IDE (Integrated Device Electronics) controller supports up to two IDE devices, including CD-ROM drives, tape backup drives, a large hard disk drive and other IDE devices. It also supports faster data transfer rates and allows IDE hard disk drives with capacities in excess of 528 MB.

### Connecting the hard drive

Connecting drives is done in a daisy-chain fashion. Wire number 1 on the cable is red or blue, while the other wires are gray.

Unlike floppy drives, IDE hard drives can connect to either end of the cable. If you install two drives, you will need to set one as the master and one as the slave by using jumpers on the drives. If you install just one drive, set it as the master.

## 2.8 44-pin Secondary Mini-pitched IDE Interface (2.5" HDD) (CN13)

---

The on-board 44-pin mini-pitched IDE interface is used to let user support either a 2.5" HDD.

Follow the same connection arrangement as the 3.5" HDD if you want to connect to a 2.5" IDE device. Read the BIOS setup section for more information regarding system settings.

## 2.9 Floppy Drive Connector (CN12)

---

You can attach up to two floppy disks to the POS-562/562L's on-board controller. You can use any combination of 5¼" (360 KB and 1.2 MB) and/or 3½" (720 KB, 1.44 MB, and 2.88 MB) drives.

A 34-pin daisy-chain drive connector cable is required for a dual-drive system. On one end of the cable is a 34-pin flat-cable connector. On the other end are two sets of floppy disk drive connectors. Each set consists of a 34-pin flat-cable connector (usually used for 3½" drives) and a printed-circuit board connector (usually used for 5¼" drives).

### Connecting the floppy drive

1. Plug the 34-pin flat-cable connector into CN12. Make sure that the red wire corresponds to pin one on the connector.
2. Attach the appropriate connector on the other end of the cable to the floppy drive(s). You can use only one connector in the set. The set on the end (after the twist in the cable) connects to the A: drive. The set in the middle connects to the B: drive.
3. If you are connecting a 5¼" floppy drive, line up the slot in the printed circuit board with the blocked-off part of the cable connector.

If you are connecting a 3½" floppy drive, you may have trouble determining which pin is pin number one. Look for a number printed on the circuit board indicating pin number one. Also, the connector on the floppy drive connector may have a slot. When the slot is up, pin number one should be on the right. Check the documentation that came with the drive for more information.

The B: drive can be attached to the connectors in the middle of the cable as described above.

## 2.10 Primary Parallel Port Connector (LPT1: CN23)

---

The primary parallel printer port is located at the rear edge of the board with the DB-25 connector. The printer port is typically used to connect a printer via an adapter cable. LPT1's IRQ is defined as IRQ7.

## 2.11 Secondary Parallel Port (LPT2: CN21)

---

The secondary parallel port is internally located next to the primary parallel port with a 26-pin box header. The IRQ setting is defined as IRQ5. You can select the LPT1 SPP/EPP/ECP selection and enable/disable from BIOS (see Chapter 4).

## 2.12 Keyboard Connector (CN1, CN7, CN9)

---



The POS-562/562L is uniquely designed to allow 3 ways for keyboard input.

- External mini-DIN PS/2 keyboard jack (CN1)
- Internal 5-pin header (CN7)
- External mini-DIN PS/2 mouse/keyboard (jumper select) jack (CN9)

---

Table 2-13: PS/2 keyboard/mouse selection (CN9) (JP2, JP3)

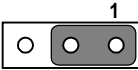
---

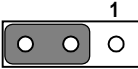
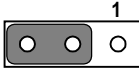
Selection	JP2	JP3
PS/2 mouse*		
PS/2 keyboard		

\* **default setting**

## 2.13 Power Connectors (CN2, CN8, CN27)

### Main power connector (CN2)

The power connection is a 12-pin connector (PS/2 or AT power standard) requiring  $\pm 5$  V and  $\pm 12$  V power. Always keep the ground wires (black color) toward the middle when connecting the power wire from the power supply.

### ATX power input connector (CN8)

The power connection is a 20-pin connector requiring  $\pm 5$  V and  $\pm 12$  V and 5VSB single.

Table 2-14: ATX/PS/2 power input selection (JP13) for CN8

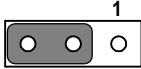
Input	JP13
ATX power	
* Main power	

\* **default setting**

### Fan power supply connector (CN27)

Provides power supply to optional CPU cooling fan. Only present when +5 V and +12 V power is supplied to the board.

### ATX power control switch (CN14)

This connector can control the power switch by button ON or switch ON.

## 2.14 Audio Interfaces (CN5, CN6)

---

The POS-562/562L is equipped with a high quality audio interface, which provides 16-bit CD-quality recording and playback as well as OPL3 compatible FM music. It is supported by all major operating systems and is 100% Sound Blaster Pro compatible.

### **Audio connector (CN5)**

The POS-562/562L provides all major audio signals on a 16-pin flat-cable connector, CN5. These audio signals includes Microphone in (mono), Line in (stereo), Line out (stereo), Speaker out (stereo). You will need an adapter cable if you use traditional telephone jack connectors for these audio signals.

### **CD audio input connector (CN6)**

All CD-ROM drives can provide analog audio signal output when used as a music CD player. The CN6 on POS-562/562L is a connector to input CD audio signal into the audio controller. The audio cable of your CD-ROM drive will be used to connect to CN6.

## 2.15 Serial Ports (COM1 - 4) (CN15, CN17, CN18, CN19, CN20, CN22)

---

The POS-562/562L has a total of four on-board RS-232 serial ports, COM1-4. They are differentiated by COM1 and COM2 (RS-232/422/485) as primary serial ports and COM3 and COM4 as secondary ports. All four serial ports have +5 V and +12 V power capabilities on both pin #1 and pin #9, depending on the jumper setting. Pin assignments for both internal and external COM ports can be found in the appendix.

### **Primary serial ports (COM1: CN19/CN22, COM2: CN17/CN20)**

Each primary serial port has two connections, one external DB-9 and one internal 10-pin header giving the user the flexibility to adapt the board to many different systems. IRQ for COM1 and COM2 is fixed with COM1 on IRQ4 and COM2 on IRQ3. COM1 and COM2 can be enabled or disabled via BIOS (see Chapter 4).



























### **Secondary serial ports (COM3: CN18, COM4: CN15)**

The secondary serial ports each have one 10-pin, internally positioned header connection. The IRQ for COM3 is fixed at IRQ10 and COM4 is fixed at IRQ5. COM3 and COM4 can be enabled/disabled via BIOS (see chapter 4).

## 2.16 COM2 RS-232/422/485 Selection (JP15, JP17 and JP18)

Follow the jumper chart below to set the desired mode for COM2.

Table 2-15: RS-232/422/485 selection jumper settings

	*RS-232		RS-422		RS-485		
JP15	1		2		2		2
	3		4		4		4
	5		6		6		6
JP17	1		2		2		2
	3		4		4		4
	5		6		6		6
JP18	1		2		2		2
	3		4		4		4
	5		6		6		6

\* default setting

### COM1 - COM4 IRQ and I/O ports

The IRQ and the address range for COM1, 2, 3, 4 are fixed. However, if you wish to disable the port or change these parameters later you can do this in the system BIOS setup. The table below shows the settings for the POS-562/562L serial ports.

Table 2-16: POS-562/562L serial port default settings

Port	Address range	Interrupt
COM1	3F8-3FF	IRQ4
COM2	2F8-2FF	IRQ3
COM3	3E8-3EF	IRQ10
COM4	2E8-2EF	IRQ5

## COM1 - COM4 RI pin +5/+12 V power setting (JP6, JP8, JP9, JP12)

COM1 - COM4 can supply  $\pm 5$  V or  $\pm 12$  V power to the serial devices via RI pin of the COM port connector. The outputs of COM1 - COM4 RI pins are selected by setting JP6, JP8, JP9, JP12.

Table 2-17: COM1 RI pin setting

	+5 V		+12 V		*RI				
JP12	1		2	1		2	1		2
	3		4	3		4	3		4
	5		6	5		6	5		6

Table 2-18: COM2 RI pin setting

	+5 V		+12 V		*RI				
JP9	1		2	1		2	1		2
	3		4	3		4	3		4
	5		6	5		6	5		6

Table 2-19: COM3 RI pin setting

	+5 V		+12 V		*RI				
JP8	1		2	1		2	1		2
	3		4	3		4	3		4
	5		6	5		6	5		6

Table 2-20: COM4 RI pin setting

	+5 V		+12 V		*RI				
JP6	1		2	1		2	1		2
	3		4	3		4	3		4
	5		6	5		6	5		6

## 2.17 VGA Interface Connections

---

The POS-562/562L's PCI SVGA interface can drive conventional CRT displays and is capable of driving a wide range of flat panel displays, including electroluminescent (EL), gas plasma, passive LCD and active LCD displays. The board has two connectors to support these displays, one for standard CRT VGA monitors and one for flat panel displays.

### **CRT display connector (CN30 and CN31)**

CN30 is a standard 15-pin D-SUB connector commonly used for the CRT VGA monitor only. CN31 is a 16-pin header connector allowing user to extend VGA connector and keyboard interface elsewhere via customized cable. Pin assignment appears in the appendix.

### **Flat panel display connector (CN29, CN28)**

CN29 consists of a 44-pin, dual-in-line header. It can connect to a 24-bit TFT LCD panel. CN28 consists of a 16-pin dual-in-line header which with CN29 can connect to a 36-bit TFT LCD panel. Pin assignments appear in the appendix. (For more information on LCD connection information between CN29/CN28 and LCD, refer to chapter 3).

## LCD power setting (JP21)

The POS-562/562L's PCI SVGA interface supports 5 V and 3.3 V LCD displays. By changing the setting of JP21, you can select the panel video signal level to be 5 V or 3.3 V.

Table 2-21: LCD power setting (JP21)



	5V	*3.3V
JP21		

Table 2-22: LCD SHFCLK polarity setting (JP20)

	*SHFCLK	/SHFCLK
JP20		

### \* default setting

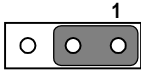
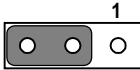
Configuration of the VGA interface is done completely via the software utility. You don't have to set any jumpers. Refer to Chapter 3 for software setup details.

Refer to Chapter 3 for details on connecting the five standard LCD's: Sharp LM64183P, LM64P89, Toshiba LTM10C042, Sharp 64C142, and Planar EL Display.

## 2.18 LVDS Interface (CN26)

The user can use this interface for long distance connection to an LCD panel. Data can be handled over a distance of 5m. The POS-562/562L supports 18-bit LVDS TFT LCD panel via an LVDS interface (CN26). It consists of a 20-pin dual-in-line header. Power supply (5 V or 3.3 V by jumper) present on CN26.

## 2.19 Ethernet Configuration

---

The POS-562/562L is equipped with a high performance 32-bit PCI-bus Ethernet interface which is fully compliant with IEEE 802.3 u 100/10Mbps CSMA/CD standards. It is supported by all major network operating systems.

The medium type can be configured via the RSET8139.EXE program included on the utility disk (see Chapter 3 for detailed information).

### **RJ-45 connector (CN11)**

100/10Base-T connects to the POS-562/562L via an RJ-45 standard jack.

### **Network boot**

The Network Boot feature can be utilized by incorporating the Boot ROM image files for the appropriate network operating system. The Boot ROM BIOS files are on the included utility disk.

## 2.20 Watchdog Timer Configuration

---

An on-board watchdog timer reduces the chance of disruptions which EMP (electro-magnetic pulse) interference can cause. This is an invaluable protective device for standalone or unmanned applications. Setup involves one jumper and running the control software (refer to Appendix A).



### **Watchdog timer action (JP7)**

When the watchdog timer activates (CPU processing has come to a halt), it can reset the system or generate an interrupt on IRQ11. This can be set via setting JP7 as shown below:

---

Table 2-23: Watchdog timer action (JP7)

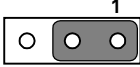
---

	*System reset	IRQ11
JP7		

---

\* default setting

## 2.21 USB Connector (CN33)

---

The POS-562/562L board provides two USB (Universal Serial Bus) interfaces which support plug and play and hot attach/detach for up to 127 external devices. The USB interfaces comply with USB specification rev. 1.0 and are fuse protected.

The USB interfaces are accessed through 10-pin (5x2) flat-cable connectors, CN33. You will need an adapter cable if you use a standard USB connector. The adapter cable has a 5-pin connector on one end and a USB connector on the other.

The USB interfaces can be disabled in the system BIOS setup.

## 2.22 IR Connector (CN25)

---

This connector supports the optional wireless infrared transmitting and receiving module. This module mounts on the system case. You must configure the setting through BIOS setup.

## 2.23 DOC® 2000 Address Setting (JP4)

Table 2-24: DOC® 2000 address setting (JP4)

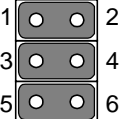
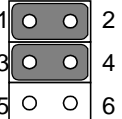
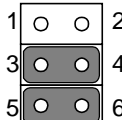
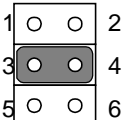
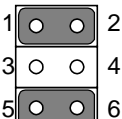
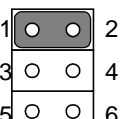
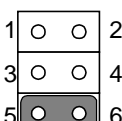
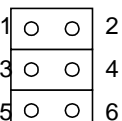
Address	JP4	Address	JP4
C800~C9FF		D800~D9FF	
CC00~CDFF		DC00~DDFF	
*D000~D1FF		E000~E1FF	
D400~D5FF		OFF	

\* default setting



## Software Configuration

This chapter details the software configuration information. It shows you how to configure the card to match your application requirements. AWARD System BIOS is covered in Chapter 4.

Sections include:

- Introduction
- VGA display software configuration
- LCD display configuration
- Connections for four standard LCDs
- Ethernet interface configuration

## 3.1 Introduction

---

The POS-562/562L system BIOS and custom drivers are located in a 128 KB, 32-pin (JEDEC spec.) Flash ROM device, designated U15. A single Flash chip holds the system BIOS, VGA BIOS, and network Boot ROM image. The display can be configured via software. This method minimizes the number of chips and eases configuration. You can change the display BIOS simply by reprogramming the Flash chip.

## 3.2 VGA Display Firmware Configuration

---

The POS-562/562L's on-board VGA interface supports a wide range of popular LCD, EL, gas plasma flat panel displays and traditional analog CRT monitors. With on-board 1 MB display memory, the interface can drive CRT displays with resolutions up to 1024 x 768 in 256 colors. It is also capable of extending up to 2 MB of display memory to provide resolutions of 1024 x 768 in 64K colors.

The VGA interface is configured completely via the software utility, so you don't have to set any jumpers. Configure the VGA display as follows:

1. Apply power to the POS-562/562L with a color TFT display attached. This is the default setting for the POS-562/562L. Ensure that the AWDFLASH.EXE and \*.BIN files are located in the working drive.

*Note:*        *Ensure that you do not run AWDFLASH.EXE while your system is operating in EMM386 mode.*

2. At the prompt, type AWDFLASH.EXE and press <Enter>. The VGA configuration program will then display the following:



*Figure 3-1: VGA setup screen*

3. At the prompt, enter the new BIN file which supports your display. When you are sure that you have entered the file name correctly press <Enter>.
4. The screen will ask “Do you want to save BIOS?” If you change your mind or have made a mistake, press N to abort and end the setup procedure. Press Y if you wish to save the existing configuration before changing it. Then type the name under which you want to save the current configuration.
5. The prompt will then ask “Are you sure to program?” Press Y if you want the new file to be written into the BIOS. Press N to exit the program.

The new VGA configuration will then write to the ROM BIOS chip. This configuration will remain the same until you run the AWDFLASH.EXE program and change the settings.

## 3.3 Connections for Four Standard LCDs

### Connections to Sharp LM64183P (640 x 480 DSTN MONO LCD)

Table 3-1: POS-562/562L connection for Sharp LM64P83  
LCD(CN12)

LM64183/64P89		POS-562/562L (CN12)	
Pin	Pin name	Pin	Pin name
CN1-1	S	36	FLM
CN1-2	CP1	38	LP
CN1-3	CP2	35	SHFCLK
CN1-4	DISP	5	+5 V
CN1-5	VDD	6	+5 V
CN1-6	VSS	3	GND
CN1-7	VEE	-	-17 V (external power)
CN1-8	DU0	12	P3
CN1-9	DU1	11	P2
CN1-10	DU2	10	P1
CN1-11	DU3	9	P0
CN1-12	DL0	16	P7
CN1-13	DL1	15	P6
CN1-14	DL2	14	P5
CN1-15	DL3	13	P4 *LM64183P -17 V

## Connections to PLANAR EL (640 x 480 AD4 EL)

Table 3-2: POS-562 connection for PLANAR EL LCD (CN12)

PLANAR 640 x 480 AD4		POS-562 (CN2)	
Pin	Pin name	Pin	Pin name
1	GND	3	GND
2	DO	21	P12
3	GND	3	GND
4	D1	22	P13
5	GND	3	GND
6	D2	23	P14
7	NC	-	-
8	D3	24	P15
9	NC	-	-
10	D4	17	P8
11	NC	-	-
12	D5	18	P9
13	NC	-	-
14	D6	19	P10
15	GND	4	GND
16	D7	20	P11
17	GND	4	GND
18	VCLK	42	ASHFCLK
19	GND	4	GND
20	/BLANK	-	-
21	GND	8	GND
22	HS	37	M
23	NC	-	-
24	VS	36	FLM
25	NC	-	-
26	SELFTTEST	39	GND
27	COLMAP	39	GND
28	ENABLE	-	-
29	RESERVED	-	-
30	/LOWPOW	-	-
31, 32	NC	-	-
33	RESERVED	-	-
34	NC	-	-

## Connections to Toshiba LTM10C042 (640 x 480 TFT color LCD)

Table 3-2: POS-562/562L connection for Toshiba LTM10C042 LCD (CN12)

LTM10C042		POS-562/562L (CN12)	
Pin	Pin name	Pin	Pin name
1	GND	3	GND
2	CLK	35	SHFCLK
3	GND	4	GND
4	R0	27	P18
5	R1	28	P19
6	R2	29	P20
7	GND	8	GND
8	R3	30	P21
9	R4	31	P22
10	R5	32	P23
11	GND	33	GND
12	G0	19	P10
13	G1	20	P11
14	G2	21	P12
15	GND	33	GND
16	G3	22	P13
17	G4	23	P14
18	G5	24	P15
19	GND	34	GND
20	ENAB	37	M
21	GND	34	GND
22	B0	11	P2
23	B1	12	P3
24	B2	13	P4
25	GND	39	GND
26	B3	14	P5
27	B4	15	P6
28	B5	16	P7
29	GND	39	GND
30	VDD	5	+5 V
31	VDD	6	+5 V

## Connections to Sharp LM64C142 (640 x 480 DSTN color LCD)

Table 3-3: POS-562/562L connection for Sharp LM64C142 LCD (CN12)

LM64C142		POS-562/562L (CN12)	
Pin	Pin name	Pin	Pin name
CN1-1	YD	36	FLM
CN1-2	LP	38	LP
CN1-3	XCX	35	SHFCLK
CN1-4	DISP	5	+5 V
CN1-5	VDD	6	+5 V
CN1-6	VSS	3	GND
CN1-7	VEE	-	+27 V (external power)
CN1-8	DU0	20	P11
CN1-9	DU1	19	P10
CN1-10	DU2	18	P9
CN1-11	DU3	17	P8
CN1-12	DU4	12	P3
CN1-13	DU5	11	P2
CN1-14	DU6	10	P1
CN1-15	DU7	9	P0
CN2-1	VSS	4	GND
CN2-2	DL0	24	P15
CN2-3	DL1	23	P14
CN2-4	DL2	22	P13
CN2-5	DL3	21	P12
CN2-6	DL4	16	P7
CN2-7	DL5	15	P6
CN2-8	DL6	14	P5
CN2-9	DL7	13	P4
CN2-10	VSS	8	GND

## 3.4 Ethernet Software Configuration

---

The POS-562/562L's on-board Ethernet interface supports all major network operating systems. To configure the medium type, to view the current configuration, or to run diagnostics, do the following:

1. Power the POS-562/562L on. Ensure that the RSET8139.EXE file is located in the working drive.
2. At the prompt type RSET8139.EXE and press <Enter>. The Ethernet configuration program will then be displayed.
3. This simple screen shows all the available options for the Ethernet interface. Just highlight the option you wish to change by using the Up and Down keys. To change a selected item, press <Enter>, and a screen will appear with the available options. Highlight your option and press <Enter>. Each highlighted option has a helpful message guide displayed at the bottom of the screen for additional information.
4. After you have made your selections and you are sure that this is the configuration you want, press ESC. A prompt will appear asking if you want to save the configuration. Press Y if you want to save.

The Ethernet Setup Menu also offers three very useful diagnostic functions. These are:

1. Run EEPROM test
2. Run Diagnostics on Board
3. Run Diagnostics on Network

Each option has its own display screen which shows the format and result of any diagnostic tests undertaken.

# CHAPTER 4

## Award BIOS Setup

This chapter describes how to set BIOS configuration data.

## 4.1 System Test and Initialization

---

These routines test and initialize board hardware. If the routines encounter an error during the tests, you will either hear a few short beeps or see an error message on the screen. There are two kinds of errors: fatal and non-fatal. The system can usually continue the boot up sequence with non-fatal errors. Non-fatal error messages usually appear on the screen along with the following instructions:

press <F1> to RESUME

Write down the message and press the F1 key to continue the bootup sequence.

### **System configuration verification**

These routines check the current system configuration against the values stored in the card's CMOS memory. If they don't match, the program outputs an error message. You will then need to run the BIOS setup program to set the configuration information in memory.

There are three situations in which you will need to change the CMOS settings:

1. You are starting your system for the first time
2. You have changed the hardware attached to your system
3. The CMOS memory has lost power and the configuration information has been erased.

The POS-562/562L's CMOS memory has an integral lithium battery backup. The battery backup should last ten years in normal service, but when it finally runs down, you will need to replace the complete unit.

## 4.2 AWARD BIOS Setup

Award's BIOS ROM has a built-in Setup program that allows users to modify the basic system configuration. This type of information is stored in battery-backed CMOS RAM so that it retains the Setup information when the power is turned off.

### Entering setup

Power on the computer and press <Del> immediately. This will allow you to enter Setup.

```
ROM PCI/ISA BIOS (2ASITAKA)
STANDARD CMOS SETUP
AWARD SOFTWARE, INC.
```

Date (mm:dd:yy) : Thu, Jan 29 1998		
Time (hh:mm:ss) : 16 : 45 : 24		
<b>HARD DISKS</b>	<b>TYPE</b> <b>SIZE</b> <b>CYLS</b> <b>HEAD</b> <b>PRECOMP</b> <b>LANDZ</b> <b>SECTOR</b> <b>MODE</b>	
Primary Master	: Auto        0        0    0    0    0    0    AUTO	
Primary Slave	: None        0        0    0    0    0    0    -----	
Secondary Master	: Auto        0        0    0    0    0    0    AUTO	
Secondary Slave	: None        0        0    0    0    0    0    -----	
Drive A : 1.44M, 3.5 in.		
Drive B : None		
Video : EGA/VGA		
Halt On : All,But Keyboard		
	Base Memory:        OK	
	Extended Memory:    OK	
	Other Memory:       512K	
	-----	
	Total Memory:      512K	
ESC : Quit	↑ ↓ → ← : Select Item	PU/PD/+/- : Modify
F1 : Help	(Shift)F2 : Change Color	

Figure 4-1: Setup program initial screen

## Standard CMOS setup

When you choose the STANDARD CMOS SETUP option from the INITIAL SETUP SCREEN menu, the screen shown below is displayed. This standard Setup Menu allows users to configure system components such as date, time, hard disk drive, floppy drive, display, and memory. Once a field is highlighted, on-line help information is displayed in the left bottom of the Menu screen.

```
ROM PCI/ISA BIOS (ZASIIAKA)
STANDARD CMOS SETUP
AWARD SOFTWARE, INC.
```

Date (mm:dd:yy) : Thu, Jan 29 1998									
Time (hh:mm:ss) : 16 : 45 : 24									
HARD DISKS	TYPE	SIZE	CYLS	HEAD	PRECOMP	L&NDZ	SECTOR	MODE	
Primary Master	: Auto	0	0	0	0	0	0	AUTO	
Primary Slave	: None	0	0	0	0	0	0	-----	
Secondary Master	: Auto	0	0	0	0	0	0	AUTO	
Secondary Slave	: None	0	0	0	0	0	0	-----	
Drive A : 1.44M, 3.5 in.									
Drive B : None									
Video : EGA/VGA									
Halt On : All,But Keyboard									
				Base Memory:		OK			
				Extended Memory:		OK			
				Other Memory:		512K			
				Total Memory:		512K			
ESC : Quit	↑ ↓ → ← : Select Item			PU/PD/+/- : Modify					
F1 : Help	(Shift)F2 : Change Color								

Figure 4-2: CMOS setup screen

## BIOS features setup

By choosing the BIOS FEATURES SETUP option from the INITIAL SETUP SCREEN menu, the screen below is displayed.

This sample screen contains the manufacturer's default values for the POS-562/562L.

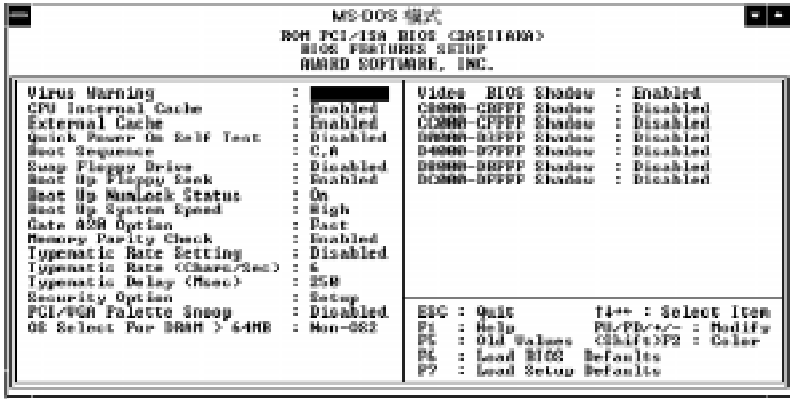

Figure 4-3: BIOS features setup screen

## CHIPSET features setup

By choosing the CHIPSET FEATURES SETUP option from the INITIAL SETUP SCREEN menu, the screen below is displayed. This sample screen contains the manufacturer's default values for the POS-562/562L.

ROM PCI/ISA BIOS (EASTMAN) CHIPSET FEATURES SETUP AWARD SOFTWARE, INC.	
Auto Configuration : Enabled	CPU to PCI Bus# Mem. WB: Disabled
LE (WB) Tag Bit Length : 8bits	ISA Bus Clock Frequency : PCCLK/4
SRAM Back-to-Back : Enabled	System BIOS Cacheable : Enabled
MBA Enable : Enabled	Video BIOS Cacheable : Enabled
Starting Point of Paging: 1T	Memory Hole at 15M-16M : Disabled
Refresh Cycle Time (ns) : 15.6	Linear Mode SRAM Support: Disabled
RAS Pulse Width Refresh : 5T	
RAS Precharge Time : 5T	
RAS to CAS Delay : 2T	
CAS# Pulse Width (FP) : 2T	
CAS# Pulse Width (MD) : 1T	
RAS# Assertion Timing : 5T	
CAS Precharge Time (FP) : 1T/2T	
CAS Precharge Time (MD) : 1T/2T	
SRAM MR Retire Rate : R-2-2-2	
SRAM Wait State Control: 1WS	
Enhanced Memory Write : Disabled	
Read Prefetch Memory RD : Enabled	
CPU to PCI Post Write : 4T	
	ESC : Quit            F10 : Select Item
	F1 : Help            F2/F3/F4/- : Modify
	F5 : Old Values    Shift+F2 : Color
	F6 : Load BIOS Defaults
	F7 : Load Setup Defaults

Figure 4-4: CHIPSET features setup screen

## Power management setup

By choosing the POWER MANAGEMENT SETUP option from the INITIAL SETUP SCREEN menu, the screen below is displayed.

This sample screen contains the manufacturer's default values for the POS-562/562L.

```
ROM PCI/ISA BIOS (2A5IIAKA)
POWER MANAGEMENT SETUP
AWARD SOFTWARE, INC.

Power Management      : Disable
PM Control by APM     : Yes
Video Off Option      : Susp,Stby -> Off
Video Off Method      : DPMS Supported
Switch Function       : Break/Wake
Doze Speed (div by):  : 2
Stdby Speed(div by):  : 3
MODEM Use IRQ        : 3
Hot Key Power Off     : Disabled

      ** PM Timers **
HDD Off After         : Disable
Doze Mode              : Disable
Standby Mode          : Disable
Suspend Mode          : Disable

      ** PM Events **
COM Ports Activity    : Enabled
LPT Ports Activity    : Enabled
HDD Ports Activity    : Enabled

VGA Activity          : Disabled
IRQ3 (COM 2)         : Enabled
IRQ4 (COM 1)         : Enabled
IRQ5 (LPT 2)         : Enabled
IRQ6 (Floppy Disk)   : Enabled
IRQ7 (LPT 1)         : Enabled
IRQ8 (RTC Alarm)     : Disabled
IRQ9 (IRQ2 Redir)    : Enabled
IRQ10 (Reserved)     : Enabled
IRQ11 (Reserved)     : Enabled
IRQ12 (PS/2 Mouse)   : Enabled
IRQ13 (Coprocessor)  : Enabled
IRQ14 (Hard Disk)    : Enabled
IRQ15 (Reserved)     : Enabled

ESC : Quit          | |< : Select Item
F1  : Help          | PU/PD/+/- : Modify
F5  : Old Values   | (Shift)F2 : Color
F6  : Load BIOS    | Defaults
F7  : Load Setup    | Defaults
```

Figure 4-5: Power management setup screen

## PnP/PCI configuration setup

By choosing the PNP/PCI CONFIGURATION option from the INITIAL SETUP SCREEN menu, the screen below is displayed. This sample screen contains the manufacturer's default values for the POS-562/562L.

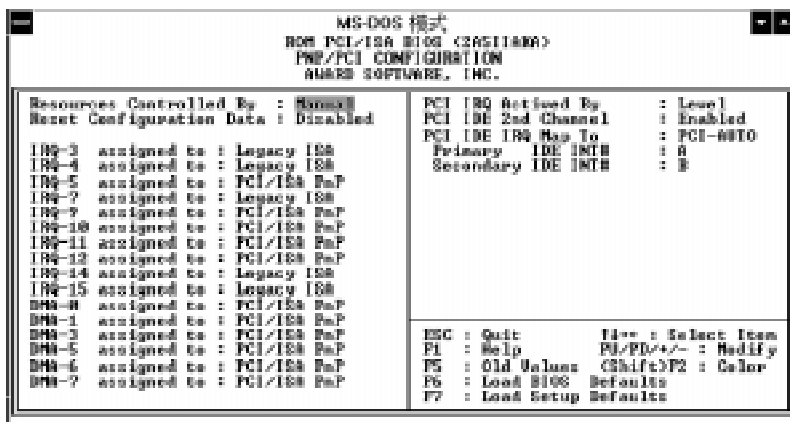

Figure 4-6: PCI configuration setup screen

## Integrated peripherals

By choosing the INTEGRATED PERIPHERALS option from the INITIAL SETUP SCREEN menu, the screen below is displayed.

This sample screen contains the manufacturer's default values for the POS-562/562L.

ROM PCI/ISA BIOS (2A5IIAKA)  
INTEGRATED PERIPHERALS  
AWARD SOFTWARE, INC.

Internal PCI/IDE : Both	Onboard Serial Port 3 : 3E8/IRQ10
IDE Primary Master PIO : Auto	Onboard Serial Port 4 : 2E8/IRQ5
IDE Primary Slave PIO : Auto	Onboard Parallel Port1 : 3F8/IRQ7
IDE Secondary Master PIO: Auto	Parallel Port Mode : ECP+EPP
IDE Secondary Slave PIO: Auto	ECP Mode Use DMA : 1
Primary Master UltraDMA: Auto	Onboard Parallel Port2 : 278/IRQ5
Primary Slave UltraDMA: Auto	Parallel Port Mode : ECP+EPP
Secondary MasterUltraDMA: Auto	ECP Mode Use DMA : 3
Secondary Slave UltraDMA: Auto	
IDE Burst Mode : Disabled	PS/2 mouse function : Enabled
IDE Data Port Post Write: Enabled	USB Controller : Disabled
IDE HDD Block Mode : Enabled	
Onboard FDC Controller : Enabled	Ethernet Boot Rom : Disabled
Onboard Serial Port 1 : 3F8/IRQ4	Panel Type : Ignore Int15 Hook
Onboard Serial Port 2 : 2F8/IRQ3	
IR Address Select : Disable	ESC : Quit ↑↓←→ : Select Item
	F1 : Help PU/PD/+/- : Modify
	F5 : Old Values (Shift)F2 : Color
	F6 : Load BIOS Defaults
	F7 : Load Setup Defaults

Figure 4-7: Integrated peripherals setup screen

## Load BIOS defaults

LOAD BIOS DEFAULTS loads the default system values directly from ROM. If the stored record created by the Setup program becomes corrupted (and therefore unusable), these defaults will load automatically when you turn the POS-562/562L on.

```
ROM PCI/ISA BIOS (2ASTIARA)
CHOS SETUP UTILITY
AWARD SOFTWARE, INC.
```

STANDARD CMOS SETUP	INTEGRATED PERIPHERALS
BIOS FEATURES SETUP	PASSWORD SETTING
CHIPSET FEATURES SETUP	IDE HDD AUTO DETECTION
POWER MANAGEMENT SETUP	SAVE & EXIT SETUP
PNP/PCI CONFIGURA	SAVING
LOAD BIOS DEFAULT	Load BIOS Default (Y/N)? Y
LOAD SETUP DEFAULTS	

```
Esc : Quit                ↑ ↓ → ← : Select Item
F10 : Save & Exit Setup   (Shift)F2 : Change Color
```

Figure 4-8: Load BIOS defaults screen

## Change password

To change the password, choose the PASSWORD SETTING option from the Setup main menu and press <Enter>.

1. If the CMOS is bad or this option has never been used, there is default password which is stored in the ROM. The screen will display the following messages:

### Enter Password:

Press <Enter>.

2. If the CMOS is good or this option has been used to change the default password, the user is asked for the password stored in the CMOS. The screen will display the following message:

### Confirm Password:

Enter the current password and press <Enter>.

3. After pressing <Enter> (ROM password) or the current password (user-defined), you can change the password stored in the CMOS. The password can be at most 8 characters long.

Remember - to enable this feature, you must first select either Setup or System in the BIOS FEATURES SETUP.

## Auto detect hard disk

The IDE HDD AUTO DETECTION utility can automatically detect the IDE hard disk installed in your system. You can use it to self-detect and/or correct the hard disk type configuration.

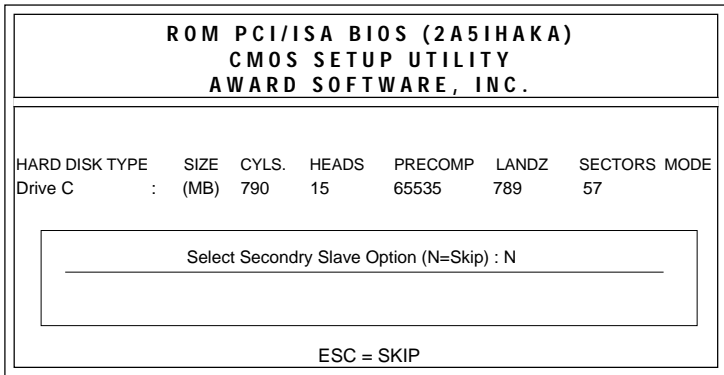

Figure 4-9: IDE HDD auto detection screen

## Save & exit setup

If you select this option and press <Enter>, the values entered in the setup utilities will be recorded in the chipset's CMOS memory. The microprocessor will check this every time you turn your system on and compare this to what it finds as it checks the system. This record is required for the system to operate.

## Exit without saving

Selecting this option and pressing <Enter> lets you exit the Setup program without recording any new values or changing old ones.

# CHAPTER 5

## **PCI SVGA Setup**

The POS-562/562L features an on-board PCI flat panel/VGA interface. This chapter provides instructions for installing and operating the software drivers on the included display driver diskette.

## 5.1 Before You Begin

---

To facilitate the installation of the enhanced display device drivers and utility software, you should read the instructions in this chapter carefully, before you attempt installation. The enhanced display drivers for the POS-562/562L board are located on the software installation diskette. You must install the drivers and utility software by using the supplied SETUP program for DOS drivers.

*Note: The files on the software installation diskette are compressed. Do not attempt to install the drivers by copying the files manually. You must use the supplied SETUP program to install the drivers.*

Before you begin, it is important to note that most display drivers need to have the relevant software application already installed in the system prior to installing the enhanced display drivers. In addition, many of the installation procedures assume you are familiar with both the relevant software applications and operating system commands. Review the relevant operating system commands and the pertinent sections of your application software's user's manual before performing the installation.

## 5.2 Installation

---

Disk 1: Windows 3.1, Windows 95 and Windows NT drivers

Disk 2: OS/2 drivers

## 5.3 Simultaneous Display Mode

---

The 65555/69000 VGA BIOS supports monochrome LCD, EL, color TFT and STN LCD flat panel displays. It also supports interlaced and non-interlaced analog monitors (VGA color and VGA monochrome) in high-resolution modes while maintaining complete IBM VGA compatibility. Digital monitors (i.e. MDA, CGA, and EGA) are NOT supported. Multiple frequency (multisync) monitors are supported as analog monitors.

Both CRT and panel displays can be used simultaneously. The POS-562/562L can be set in one of three configurations: on a CRT, on a flat panel display, or on both simultaneously. The system is initially set to simultaneous display mode. In the utility diskette, there are three .COM files which can be used to select the display. Simply type the filename at the DOS prompt:

**CT.COM** Enables CRT display only

**FP.COM** Enables panel display only

**SM.COM** Enables both displays at the same time.

## 5.4 Sleep Mode

---

The display driver diskette contains two files that support sleep mode. Simply type the filename at the DOS prompt:

**ON.COM** switches to normal display mode.

**OFF.COM** switches to sleep mode.

## 5.5 Driver Installation

---

### **Necessary prerequisites**

The instructions in this manual assume that you understand elementary concepts of MS-DOS and the IBM Personal Computer. Before you attempt to install any driver or utility you should: know how to copy files from a floppy disk to a directory on the hard disk, understand the MS-DOS directory structure, and know how to format a floppy disk. If you are uncertain about any of these concepts, please refer to the DOS or Windows user reference guides for more information before you proceed with the installation.

### **Before you begin**

Before you begin installing software drivers, you should make a backup copy of the display driver diskette and store the original in a safe place. The display driver diskette contains drivers for several versions of certain applications. You must install the correct version in order for the driver to work properly so make sure you know which version of the application you have.

## Windows setup

These drivers are designed to work with Microsoft Windows 3.1. You may install these drivers through Windows or in DOS.

**Step 1:** Install Windows as you normally would for a VGA display. Run Windows to make sure that it is working correctly.

**Step 2:** Place the display driver diskette in drive A. In Windows Program Manager, choose **File** from the Options Menu. Then from the pull-down menu, choose **Run . . .**. At the command line prompt, type **A:\SETUP**. Press the <ENTER> key or click **OK** to begin the installation. At this point the setup program locates the directory where Windows is installed. For proper operation, the drivers must be installed in the Windows subdirectory. Press <ENTER> to complete the installation. Once completed, the Display Driver Control Panel appears on the screen. This Control Panel allows you to select and load the installed drivers.

Another method of installing these drivers is through the File Manager. Click on **Drive A:**. Then double-click on **SETUP.EXE** to begin installation.

### Changing display drivers in Windows

To change display drivers in Windows, select the **Windows Setup** icon from the Main window. You will be shown the current setup configuration. Select **Change System Settings** from the Option menu. Click on the arrow at the end of the Display line. You will be shown a list of display drivers. Click on the driver you want. Then click on the **OK** button. Follow the directions to complete the setup.

### Changing color schemes

After you change display drivers, you may notice that the color scheme used by Windows looks strange. This is because different drivers have different default colors. To change the color scheme, select the **Control Panel** from the Main window. Select the **Color** icon. You will be shown the current color scheme. Choose a new color scheme and click the **OK** button.

## DOS setup

**Step 1:** Install Windows as you normally would for a VGA display. Run Windows to make sure that it is working correctly. Then exit Windows.

**Step 2:** Place the display driver diskette in drive A. Type **A:** <ENTER> to make this the default drive. Type **SETUP** <ENTER> to run the driver SETUP program. Press any key to get to the applications list. Using the arrow keys, select **Windows Version 3.1** and press the <ENTER> key. Press the <ENTER> key to select **All Resolutions**, and then press <END> to begin the installation. At this point you will be asked for the path to your Windows System directory (default C:\WINDOWS). When the installation is complete, press any key to continue. Press <ESC> followed by Y to exit to DOS.

**Step 3:** Change to the directory where you installed Windows (usually C:\WINDOWS).

**Step 4:** Type **SETUP** <ENTER> to run the Windows Setup program. It will show the current Windows configuration. Use the up arrow key to move to the Display line and press <ENTER>. A list of display drivers will be shown. Use the arrow keys to select one of the drivers starting with an asterisk (\*) and press <ENTER>.

**Step 5:** Follow the directions on the screen to complete the setup. In most cases, you may press <ENTER> to accept the suggested option. When Setup is done, it will return to DOS. Type **WIN** <ENTER> to start Windows with the new display driver.

### **Changing display drivers in DOS**

To change display drivers from DOS, change to the Windows directory and run Setup, repeating steps 4 and 5 from the previous page. Besides the special display drivers marked by an asterisk (\*), you should be able to use the following standard drivers:

VGA	640x480, 16 colors
Super VGA	800x600, 16 colors

### **Panning drivers**

Special panning drivers are provided to allow high-resolution modes to be displayed on a flat panel or CRT. These drivers will show a section of a larger screen and will automatically pan, or scroll, the screen horizontally and vertically when the mouse reaches the edge of the display.

### **Linear acceleration drivers**

A special high-performance linear acceleration driver is provided for 256-color modes. This driver may require special hardware and may not be supported on all systems. It is only available for Windows3.1.

## **5.6 Windows 95 Drivers Setup Procedure**

---

1. Boot your system with VGA or SuperVGA driver.
2. Select Properties from a menu after right button press.
3. Select Display.
4. Select Change Display.
5. Select Change Monitor.
6. Select Change Adapter.
7. Select Have Disk.

## 5.7 Windows NT Drivers Setup Procedure

---

### Step 1

1. Install Windows NT as you normally would for a VGA display.
2. Click the Start button, choose Settings and click on Control Panel.
3. Choose the Display icon and click on the icon.
4. In the Display Properties window, click on the Settings tab.
5. Click on Change Display Type. In the Change Display Type window, click on the Change button under Adapter Type. This will bring up the Select Device window.

### Step 2

1. In the Select Device window, click on the Other button. Enter source directory where the Windows NT driver files are located.
2. Press <ENTER> and the name of the Chips and Technologies Video Accelerator driver will appear at the end of the Models list box. Scroll to the end of the list box and double click on the driver.
3. Once the installation is complete, the system must be restarted.

### Step 3

1. Upon restarting your computer, select the desired display settings from the Display property dialog box.
2. Click on Test to test the newly selected graphics mode. A color test screen should appear, followed by the Testing Mode window.
3. Click on Yes to continue. The Display Settings Change window will appear.
4. Click on Restart Now for the new settings to take effect.

## 5.8 OS/2 Drivers Setup Procedure

---

### Preliminary steps

The following steps must be performed before you install the 65555/69000 display driver:

1. OS/2 DOS Support must be installed.
2. If you previously installed SVGA support, you must reset the system to VGA mode. VGA is the default video mode enabled when OS/2 is installed.

To restore VGA mode, use Selective Install and select VGA for Primary Display. For more information on this procedure, see the section on Changing Display Adapter Support in the OS/2 User's Guide.

### Installing from diskette

To install this driver, do the following steps:

1. Open an OS/2 full screen or windowed session.
2. Place the 65555/69000 PCI Display Driver Diskette in drive A.
3. At the OS/2 command prompt, type the following commands to copy the files to the OS/2 drive:

Type:

```
A: <ENTER> to make this the default drive.
```

```
SETUP A: C: <ENTER>
```

where A: is the floppy disk drive and  
C: is the hard disk partition containing \OS2

When the Setup Program is completed, you will need to perform a shutdown and then restart the system in order for changes to take effect.

A log of the information output during the install can be found in  
<root>:\OS2\INSTALL\DISPLAY.LOG

4. After restarting the system, perform the following steps:

- 1) Open the OS/2 System folder.
- 2) Open the System Setup folder.
- 3) Open the Display Driver Install Object

This step will execute the Display Driver Installation (DSPIN-STL) utility program to finish installation of the new drivers.

- 4) When the Display Driver Install window appears, select Primary Display and then select OK.
- 5) When The Primary Display Driver List window appears, select "Chips and Technologies 65555/554" from the list of adapter types, then select OK to install the video driver.
- 6) When the installation is complete, you will need to shutdown and then restart the system for the changes to take effect. Be sure to remove the installation diskette before restarting the system.

When the system has restarted, the display driver will be initialized for 640x480 at 256 colors, 60 Hz refresh. To switch to a different video resolution color depth, or refresh rate, follow the steps below.

## Selecting monitor type

Monitor type is initially set to DEFAULT. This DEFAULT setting may not allow you to select all resolution/refresh combinations that are available for your monitor. The following steps can be done to select monitor type. This section applies only after installation, or when a different monitor is used.

1. Open the OS/2 System folder.
2. Open the System Setup folder.
3. Open the System object.
4. When the System - Settings notebook appears, select the Screen tab. This will take you to page 2 of the settings.
5. On Screen page 2, select your monitor type from the Display Name list. If your monitor is not listed, select DEFAULT. Return to Screen page 1.

It may be necessary to restart your system to have all refresh rate options available.

## Selecting screen resolution/refresh rate

To switch to a different video resolution, color depth or refresh rate, follow the steps below.

1. Open the OS/2 System folder.
2. Open the System Setup folder.
3. Open the System object.
4. From the selection windows provided, select a new Screen Resolution and Screen refresh rate.

Please note, refresh rates, other than 60 Hz, are only valid when the display is switched to CRT only display mode.

5. Close the System-Settings notebook.
6. Perform a shutdown and restart for the changes to take effect.

## Installation notes

1. During the installation of this driver, DISPLAY.LOG and DSPINSTL.LOG files are created in \OS2\INSTALL directory. These files identify the OS/2 system files that were updated, and indicate whether the installation was successful. The DISPLAY.LOG file also contains a string that identifies the version of driver that was installed. This information may be important when reporting an installation problem.
2. During installation, DSPINSTL will invoke the SVGA Configuration program SVGA.EXE to determine the hardware configuration, and create the file: \OS2\INSTALL\SVGADATA.PMI. If this file is not created, the adapter will not be supported. When this step is done, the display will be blanked, and you may see a series of flashes on the display and/or what appears to be a “corrupted” display. This is normal, as the configuration process is doing Video BIOS mode sets to determine which screen resolutions BIOS supports. This configuration information is then used to provide the System-Settings Resolution and Refresh selections.

## Audio Setup

The POS-562 is equipped with an audio interface that records and plays back CD-quality audio. This chapter provides instructions for installing the software drivers on the included audio driver diskettes.

## 6.1 Introduction

---

The POS-562 on board audio interface provides high-quality stereo sound and FM music synthesis (ESFM) by using the ES1869 audio controller from ESS Technology, Inc. The audio interface can record, compress, and play back voice, sound, and music with built-in mixer control.

The POS-562 on board audio interface also supports the Plug and Play (PnP) standard and provides PnP configuration for the audio, FM, and MPU-104 logical devices. It is compatible with Sound Blaster™; Sound Blaster Pro™ version 3.01, voice and music functions. The ESFM synthesizer is register compatible with the OPL3 and has extended capabilities.

## 6.2 DOS Utilities

---

The ES1869 audio controller supports PC games and applications for Sound Blaster™ and Sound Blaster™ with no needs of device driver in DOS environment. The default setting for audio controller in DOS are listed as follows.

```
Address : 220H
IRQ      : 9
DMA      : 1
MPU-401 : Disabled
```

### Changing setting in DOS

The audio controller setting can be changed in DOS environment by using the DOS SETUP utility located in the UTILITY subdirectory of audio driver diskette.

To change the setting, simply type the **DOSSET** at the DOS prompt. Follow the instructions on screen to choose the new setting for the ES1869 audio controller.

### Controlling volume in DOS

The ES1869 audio controller provides software control on the setting of audio volumes. The **VOLUME CONTROL** utility located in the **UTILITY** subdirectory of audio driver diskette is used to control the volume setting in DOS.

To control the volume setting, simply type the **ESSVOL** at the DOS prompt with appropriate parameters. The syntax of **ESSVOL** is shown as follows.

**ESSVOL** [/?] [/v:xx] [/l:xx] [/w:xx] [/m:xx] [/c:xx] [/s:xx] [/a:xx]

no option	Display all volume settings.
/?	Display this message.
/v	Change master volume.
/l	Change line volume.
/w	Change wave volume.
/m	Change microphone volume.
/c	Change CD volume.
/s	Change Synthesizer volume.
/a	Change AuxB volume.
/p	Change PC Speaker volume.
xx	Volume. Note: no xx means 0 The value range of volume is 0 - 15. [PC Speaker volume range is 0 - 7]

## 6.3 Driver Installation

---

### Before you begin

To facilitate the installation of the audio drivers, you should read the instructions in this chapter carefully before you attempt installation. The audio drivers for the POS-562 board are located on the audio driver diskettes. You must install the drivers by using the supplied SETUP program.

**Note:** *The files on the software installation diskette are compressed. Do not attempt to install the drivers by copying the files manually. You must use the supplied SETUP program to install the drivers.*

### Windows 3.1 drivers

These drivers are designed to work with Microsoft Windows 3.1. You may install these drivers through Windows.

1. Run Windows to make sure that it is working correctly.
2. Place the audio driver diskette in drive A. In the Windows Program Manager, choose **File** from the Options Menu. Then from the pull-down menu, choose **Run . . .** At the command line prompt, type **A:\WIN31\SETUP**. Press the <ENTER> key or click **OK** to begin the installation.
3. Click **Continue** when the “AudioDrive Setup” screen show up. Click the **Driver Installation** button to choose installing the audio driver.
4. At this point, the setup program displays the “Set Hardware Setting” screen, which allows you to change the hardware setting of audio controller in Windows. For proper operation, make sure the address, IRQ, and DMA settings are not used by other hardware. Press <ENTER> key or click **OK** to complete the installation.

Once completed, you can change the settings or remove the audio driver by using Windows' Control Panel program.

## Windows 95 drivers

1. Boot your system and place the audio driver diskette in drive A.
2. Select **Add New Hardware** from Windows' Control Panel.
3. Click **Next** to bring up the Windows search for new hardware setup screen.
4. Select **No** and click **Next** button.
4. Select **Sound, video and game controllers** from the **Hardware types** list and click **Next** button.
5. Click **Have Disk**, type **A:\WIN95** and press <ENTER> at the prompt.
6. Select **ES1869 Control Interface** and **ES1869 Plug and Play AudioDrive**. Press the <ENTER> key or click **OK** to begin the installation.
7. Restart your computer after the installation completed.



# APPENDIX **A**

## **Programming the Watchdog Timer**

The POS-562/562L is equipped with a watchdog timer that resets the CPU or generates an interrupt if processing comes to a standstill for whatever reason. This feature ensures system reliability in industrial standalone, or unmanned, environments.

## A.1 Programming the Watchdog Timer

---

In order to program the watchdog timer, you must write a program which writes I/O port address 443 (hex). The output data is a value of time interval. The value range is from 01(hex) to 3F(hex), and the related time interval is 1 sec. to 63 sec.

<b>Data</b>	<b>Time Interval</b>
01	1 sec.
02	2 sec.
03	3 sec.
04	4 sec.
.	.
.	.
3F	63 sec.

After data entry, your program must refresh the watchdog timer by rewriting the I/O port 443 (hex) while simultaneously setting it.

When you want to disable the watchdog timer, your program should read I/O port 443 (hex).

The following example shows how you might program the watchdog timer in BASIC:

```
10  REM  Watchdog timer example program
20  OUT &H443, data  REM  Start and restart the
    watchdog
30  GOSUB 1000  REM  Your application task #1
40  OUT &H443, data  REM  Reset the timer
50  GOSUB 2000  REM  Your application task #2
60  OUT &H443, data  REM  Reset the timer

70  X=INP (&H443) REM  Disable the watchdog timer
80  END

1000 REM  Subroutine #1, your application task
    .
    .
    .
1070 RETURN
2000 REM  Subroutine #2, your application task
    .
    .
    .
2090 RETURN
```

# APPENDIX **B**

## Pin Assignments

This appendix contains information of a detailed or specialized nature. It includes:

- Internal CRT display connector
- CRT display connector
- Flat panel display connector
- Flat panel display connector extension
- LVDS interface connector
- USB connector
- Fan power connector
- LAN LED connector
- HDD LED connector
- Speaker connector
- CD audio in connector
- ATX power connector
- ATX power control switch
- Ethernet RJ-45 connector
- IR connector
- Audio connector
- Main power connector
- PS/2 keyboard connector
- PS/2 mouse connector
- COM2 serial port connectors
- COM1, 3, 4 connections
- PCI/ISA slot
- IDE hard drive connector
- Floppy drive connector
- Parallel port connectors
- System I/O ports
- 1st MB memory map
- DMA channel assignments
- IRQ mapping chart

## Internal CRT display connector (CN31)

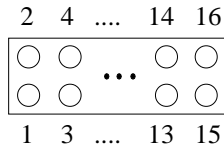

Table B-1: POS-562 internal CRT VGA connector (CN31)

Pin	Signal	Pin	Signal
1	RED	9	GND
2	DATA	10	H-SYNC
3	GREEN	11	SIGNAL GND
4	GND	12	V-SYNC
5	BLUE	13	SIGNAL GND
6	CLOCK	14	N/C
7	N/C	15	SIGNAL GND
8	N/C	16	N/C

## CRT display connector (CN30)

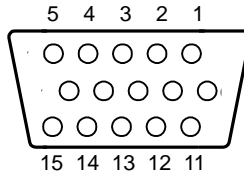

Table B-2: POS-562 CRT VGA connector (CN30)

Pin	Signal	Pin	Signal
1	RED	9	N/A
2	GREEN	10	GND
3	BLUE	11	N/A
4	NC	12	N/A
5	GND	13	HSYNC
6	GND	14	VSYNC
7	GND	15	N/A
8	GND		

## Flat panel display connector (CN29)

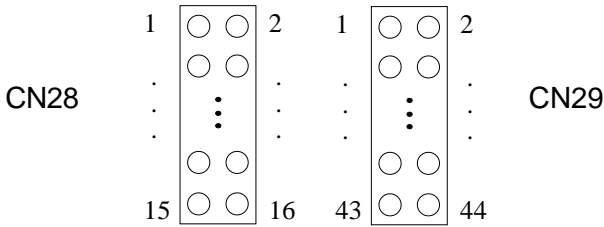

Table B-1: POS-562 flat panel display connector (CN29)

Pin	Signal	Pin	Signal
1	+12 V	2	+12 V
3	GND	4	GND
5	V <sub>CC</sub> (3.3 V/5 V)	6	V <sub>CC</sub> (3.3 V/5 V)
7	ENAVEE*	8	GND
9	P0	10	P1
11	P2	12	P3
13	P4	14	P5
15	P6	16	P7
17	P8	18	P9
19	P10	20	P11
21	P12	22	P13
23	P14	24	P15
25	P16	26	P17
27	P18	28	P19
29	P20	30	P21
31	P22	32	P23
33	GND	34	GND
35	SHFCLK/ASHFCLK	36	FLM
37	M	38	LP
39	GND	40	ENABKL*
41	N.C.	42	N.C.
43	N.C.	44	N.C.

\* Low active

*Note:* Pin 35 "SHFCLK /ASHFCLK" can be set by JP20.

*Note:* Pin 5 and Pin 6 "3.3V / 5V" can be set by JP21.

## Flat panel display connector extension (CN28)

Table B-4: POS-562 flat panel display connector extension (CN28)

Pin	Function	Pin	Function
1	3.3/5 V	2	+5 V ( $V_{cc}$ )
3	P24	4	P25
5	P26	6	P27
7	P28	8	P29
9	P30	10	P31
11	P32	12	P33
13	P34	14	P35
15	GND	16	GND

Note: Pin1 "3.3/5 V" can be set by JP21.

## LVDS interface connector (CN26)

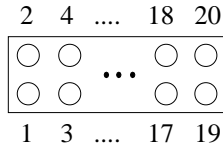

Table B-5: POS-562 LVDS interface connector (CN26)

Pin	Signal	Pin	Signal
1	VDD	2	VDD
3	VDD	4	VDD
5	GND	6	GND
7	GND	8	GND
9	TX0+	10	TX0+
11	GND	12	TX1-
13	TX1+	14	GND
15	TX2-	16	TX2+
17	GND	18	TXCK-
19	TXCK+	20	GND

## Universal serial bus (USB) connector (CN33)

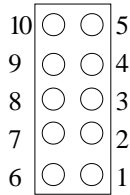

Table B-6: POS-562 universal serial bus (USB) connector (CN33)

Pin	Function	Pin	Function
1	+5 V	6	+5 V
2	UV-	7	UV-
3	UV+	8	UV+
4	GND	9	GND
5	N.C.	10	N.C.

## Fan power connector (CN27)

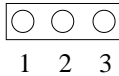

Table B-7: POS-562 fan power connector (CN27)

Pin	Signal
1	+5 V
2	GND
3	+12 V

## LAN LED connector (CN10)

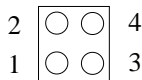

Table B-8: POS-562 LAN LED (CN10)

Pin	Signal
1	LED1+ (Tx/Rx)
2	LED1- (Tx/Rx)
3	LED0+ (Link)
4	LED0- (Link)

## HDD LED connector (CN4)



Table B-9: POS-562 HDD LED connector (CN4)

Pin	Signal
1	HDD LED+ ( $V_{CC}$ )
2	HDD LED- (HARD DISK ACTIVE)

## Speaker connector (CN32)

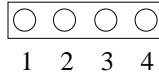

Table B-10: POS-562 speaker connector (CN32)

Pin	Signal
1	Speaker- (GND)
2	Speaker- (GND)
3	Speaker- (GND)
4	Speaker+

## CD audio in connector (CN6)

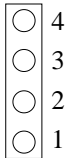

Table B-11: POS-562 CD audio in connector (CN6)

Pin	Signal
1	CD AUDIO L
2	GND
3	CD AUDIO R
4	GND

## ATX power connector (CN8)

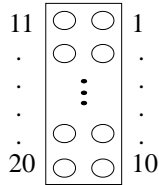

Table B-12: POS-562 ATX power connector (CN8)

Pin	Function	Pin	Function
1	3.3 V	11	3.3 V
2	3.3 V	12	-12 V
3	GND	13	GND
4	+5 V	14	PS ON
5	GND	15	GND
6	+5 V	16	GND
7	GND	17	GND
8	POWER OK	18	-5 V
9	5 V SB	19	+5 V
10	+12 V	20	+5 V

## ATX power control switch (CN14)

Table B-13: POS-562 ATX power control switch (CN14)

Pin	Signal
1	SWITCH ON
2	GND
3	GND (Reserve)
4	BUTTON ON (Reserve)

## Ethernet RJ-45 connector (CN11)

Table B-14: POS-562 Ethernet RJ-45 connector (CN11)

Pin	Function	Pin	Function
1	TD+	5	NC
2	TD-	6	RD-
3	RD+	7	NC
4	NC	8	NC

## IR connector (CN25)

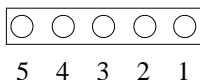

Table B-15: POS-562 IR connector (CN25)

Pin	Signal
1	$V_{CC}$
2	VIO (Reserve)
3	IR IN
4	GND
5	IR OUT

## Audio connector (CN5)

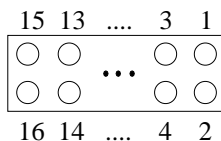

Table B-16: POS-562 audio connector (CN5)

Pin	Signal	Pin	Signal
1	SPEAKER OUT R+	2	GND
3	SPEAKER OUT L+	4	GND
5	LINE OUT R	6	LINE OUT L
7	GND	8	GND
9	LINE IN R	10	LINE IN L
11	GND	12	GND
13	NC	14	NC
15	MIC IN	16	GND

## Main power connector (CN2)



Table B-17: POS-562 main power connector (CN2)

Pin	Signal	Pin	Signal
1	NC	7	GND
2	+5 V	8	GND
3	+12 V	9	-5 V
4	-12 V	10	+5 V
5	GND	11	+5 V
6	GND	12	+5 V

## PS/2 keyboard connector (CN1)

Table B-18: POS-562 PS/2 keyboard connector (CN1)

Pin	Signal
1	KB_DT
2	NC
3	GND
4	+5 V
5	KB_CK
6	NC

## PS/2 mouse connector (CN9)

Table B-19: POS-562 PS/2 mouse connector (CN9)

Pin	Signal
1	MS_DT
2	NC
3	GND
4	+5 V
5	MS_CK
6	NC

## COM2 RS-232/422/485 serial port connectors (CN17, CN20)

Table B-20: POS-562 COM2 RS-232/422/485 serial port (CN17, CN20)

Pin	RS-232 port	RS-422 port	RS-485 port
1	DCD	TXD-	DATA-
2	RX	NC	NC
3	TX	TXD+	DATA+
4	DTR	NC	NC
5	GND	RXD+	NC
6	DSR	NC	NC
7	RTS	RXD-	NC
8	CTS	NC	NC
9	RI/+5 V/+12 V	NC	NC
10	NC	NC	NC

## COM1, COM3, COM4 RS-232 connections (COM1: CN19/CN22, COM3: CN18, COM4: CN15)

Different devices implement the RS-232 standard in different ways. If you are having problems with a serial device, be sure to check the pin assignments for the connector. The following table shows the pin assignments for the board's RS-232 port.

Table B-21: POS-562 COM1, 3, 4 RS-232 serial ports (CN15, CN18, CN19, CN22)

Pin	Signal
1	DCD
2	RX
3	TX
4	DTR
5	GND
6	DSR
7	RTS
8	CTS
9	RI/+5 V/+12 V

Note: Pin 10 on internal COM 1-4 are all NC.

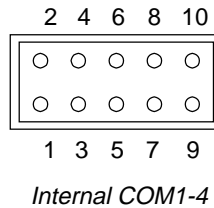
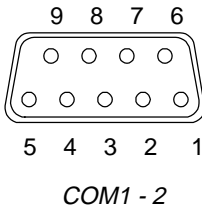

## PCI/ISA slot (component side view) (slot 1)

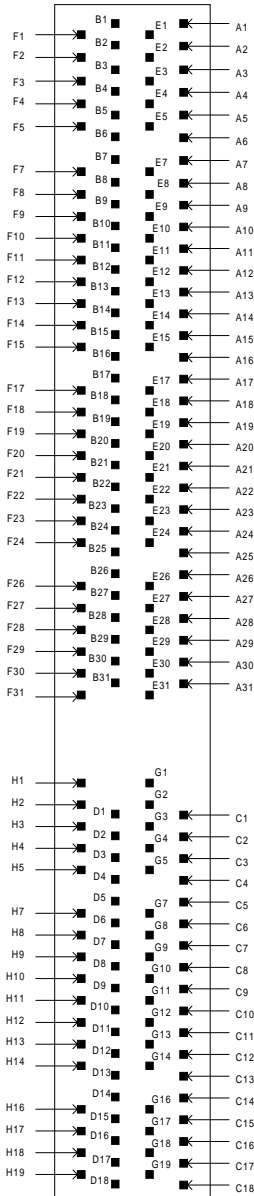

Table B-22: POS-562 PCI/ISA slot pin assignments (pins A and B)

<b>Pin</b>	<b>Signal</b>	<b>Pin</b>	<b>Signal</b>
A1	IOCHK	B1	GND
A2	SD7	B2	RST
A3	SD6	B3	VCC
A4	SD5	B4	IRQ9
A5	SD4	B5	-5 V
A6	SD3	B6	DRQ2
A7	SD2	B7	-12 V
A8	SD1	B8	OWS
A9	SD0	B9	+ 12 V
A10	IORDY	B10	GND
A11	AEN	B11	SMW
A12	SA19	B12	SMR
A13	SA18	B13	IOW
A14	SA17	B14	IOR
A15	SA16	B15	DACK3
A16	SA15	B16	DRQ3
A17	SA14	B17	DACK1
A18	SA13	B18	DRQ1
A19	SA12	B19	REF
A20	SA11	B20	SCLK
A21	SA10	B21	IRQ7
A22	SA9	B22	IRQ6
A23	SA8	B23	IRQ5
A24	SA7	B24	IRQ4
A25	SA6	B25	IRQ3
A26	SA5	B26	DACK2
A27	SA4	B27	TC
A28	SA3	B28	ALE
A29	SA2	B29	VCC
A30	SA1	B30	OSC
A31	SA0	B31	GND

Table B-23 POS-562 PCI/ISA slot pin assignments (pins C and D)

<b>Pin</b>	<b>Signal</b>	<b>Pin</b>	<b>Signal</b>
C1	SBHE	D1	MEM16
C2	LA23	D2	IO16
C3	LA22	D3	IRQ10
C4	LA21	D4	IRQ11
C5	LA20	D5	IRQ12
C6	LA19	D6	IRQ15
C7	LA18	D7	IRQ14
C8	LA17	D8	DACK0
C9	MEMR	D9	DRQ0
C10	MEMW	D10	DACK5
C11	SD8	D11	DRQ5
C12	SD9	D12	DACK6
C13	SD10	D13	DRQ6
C14	SD11	D14	DACK7
C15	SD12	D15	DRQ7
C16	SD13	D16	VCC
C17	SD14	D17	MASTER
C18	SD15	D18	GND

Table B-24 POS-562 PCI/ISA slot pin assignments (pins E and F)

<b>Pin</b>	<b>Signal</b>	<b>Pin</b>	<b>Signal</b>
E1	GND	F1	GND
E2	GND	F2	GND
E3	INT 1	F3	INT3
E4	INT 2	F4	INT4
E5	VCC	F5	VCC
E6	---	F6	---
E7	VCC	F7	VCC
E8	RST	F8	PCLKF
E9	GNT0	F9	GND
E10	REQ0	F10	GND
E11	GND	F11	GNT1
E12	PCLKE	F12	REQ1
E13	GND	F13	AD31
E14	AD30	F14	AD29
E15	NC	F15	NC
E16	---	F16	---
E17	NC	F17	NC
E18	AD28	F18	AD27
E19	AD26	F19	AD25
E20	AD24	F20	CBE3
E21	AD22	F21	AD23
E22	AD20	F22	AD21
E23	AD18	F23	AD19
E24	NC	F24	NC
E25	---	F25	---
E26	IDSEL1	F26	NC
E27	AD16	F27	AD17
E28	FRAME	F28	IRDY
E29	CBE2	F29	DEVSEL
E30	TRDY	F30	LOCK
E31	STOP	F31	PERR

Table B-25: POS-562 PCI/ISA slot pin assignments (pins G and H)

<b>Pin</b>	<b>Signal</b>	<b>Pin</b>	<b>Signal</b>
G1	SDONE	H1	SERR
G2	SBO	H2	AD15
G3	CBE1	H3	AD14
G4	PAR	H4	AD12
G5	GND	H5	GND
G6	---	H6	KEY
G7	GND	H7	GND
G8	AD13	H8	AD10
G9	AD11	H9	AD8
G10	AD9	H10	AD7
G11	CBEO	H11	AD5
G12	AD6	H12	AD3
G13	AD4	H13	AD1
G14	AD2	H14	AD0
G15	---	H15	KEY
G16	VCC	H16	VCC
G17	VCC	H17	VCC
G18	GND	H18	GND
G19	GND	H19	GND

## IDE hard drive connector (CN16, CN13)

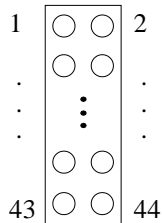

Table B-26: POS-562 IDE hard drive connector (CN16, CN13)

Pin	Signal	Pin	Signal
1	IDE RESET*	2	GND
3	DATA7	4	DATA8
5	DATA6	6	DATA9
7	DATA5	8	DATA10
9	DATA4	10	DATA11
11	DATA3	12	DATA12
13	DATA2	14	DATA13
15	DATA1	16	DATA14
17	DATA0	18	DATA15
19	SIGNAL GND	20	N/C
21	HDD 0	22	GND
23	IO WRITE	24	GND
25	IO READ	26	GND
27	HD READY	28	N/C
29	HDACK 0*	30	GND
31	IRQ14	32	N/C
33	ADDR 1	34	N/C
35	ADDR 0	36	ADDR 2
37	HDD SELECT 0*	38	HDD SELECT 1*
39	IDE ACTIVE 0*	40	GND
41	VCC (CN13 only)	42	VCC (CN13 only)
43	GND (CN13 only)	44	N/C (CN13 only)

\* Low active

## Floppy drive connector (CN12)

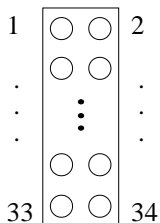

Table B-27: POS-562 floppy drive connector (CN12)

Pin	Signal	Pin	Signal
1	GND	2	DENSITY SELECT*
3	GND	4	N/C
5	GND	6	DRIVE TYPE
7	GND	8	INDEX*
9	GND	10	MOTOR 0*
11	GND	12	DRIVE SELECT 1*
13	GND	14	DRIVE SELECT 2*
15	GND	16	MOTOR 1*
17	GND	18	DIRECTION*
19	GND	20	STEP*
21	GND	22	WRITE DATA*
23	GND	24	WRITE GATE*
25	GND	26	TRACK 0*
27	GND	28	WRITE PROTECT*
29	GND	30	READ DATA*
31	GND	32	HEAD SELECT*
33	GND	34	DISK CHANGE*

\* Low active

## Parallel port connectors (CN21, CN23)

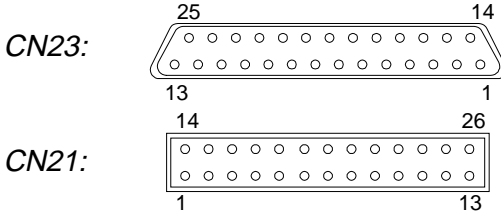

Table B-28: POS-562 parallel port connector (CN21, CN23)

Pin	Signal	Pin	Signal
1	STROBE*	2	AUTOFD*
3	D0	4	ERR
5	D1	6	INIT*
7	D2	8	SLCTINI*
9	D3	10	GND
11	D4	12	GND
13	D5	14	GND
15	D6	16	GND
17	D7	18	GND
19	ACK*	20	GND
21	BUSY	22	GND
23	PE	24	GND
25	SLCT	26	N/C

\* Low active

## System I/O ports

Table B-29: POS-562 system I/O ports

Addr. range (Hex)	Device
000-01F	DMA controller
020-021	Interrupt controller 1, master
022-023	Chipset address
040-05F	8254 timer
060-06F	8042 (keyboard controller)
070-07F	Real-time clock, non-maskable interrupt (NMI) mask
080-09F	DMA page register,
0A0-0BF	Interrupt controller 2
0C0-0DF	DMA controller
0F0	Clear math co-processor
0F1	Reset math co-processor
0F8-0FF	Math co-processor
1F0-1F8	Fixed disk
200-207	Game I/O
278-27F	Parallel printer port 2 (LPT 3)
2E8-2EF	Serial port 4
2F8-2FF	Serial port 2
300-31F	Prototype card
360-36F	Reserved
378-37F	Parallel printer port 1 (LPT 2)
380-38F	SDLC, bisynchronous 2
3A0-3AF	Bisynchronous 1
3B0-3BF	Monochrome display and printer adapter(LPT1)
3C0-3CF	Reserved
3D0-3DF	Color/graphics monitor adapter
3E8-3EF	Serial port 3
3F0-3F7	Diskette controller
3F8-3FF	Serial port 1
443	Watchdog timer

\* PNP audio I/O map range from 220 ~ 250H (16 bytes)  
 MPU-401 select from 300 ~ 330H (2 bytes)

## 1st MB memory map

Table B-30: POS-562 1st MB memory map

Addr. range (Hex)	Device
F000h - FFFFh	System ROM
DC00h - EFFFh	Unused
* D000h - D400h	DOC <sup>®</sup> 2000
**CC00h - DBFFh	Ethernet ROM
C000h - CBFFh	Expansion ROM
B800h - BFFFh	CGA/EGA/VGA text
B000h - B7FFh	Unused
A000h - AFFFh	EGA/VGA graphics
0000h - 9FFFh	Base memory

\* Default setting

\*\* If Ethernet Boot ROM enabled

## DMA channel assignments

Table B-31: POS-562 DMA channel assignments

Channel	Function
0	Available
1	Available
2	Floppy disk (8-bit transfer)
3	Available
4	Cascade for DMA controller 1
5	Available
6	Available
7	Available

\* Audio DMA select 0, 1 or 3

## IRQ mapping chart

Table B-32: POS-562 IRQ mapping chart

IRQ	Function
0	Interval timer
1	Keyboard
2	Interrupt from controller 2
3	COM2
4	COM1
5	COM4 / LPT2
6	FDD
7	LPT1
8	RTC
9	Unused
10	COM3
11	Watchdog timer
12	PS/2 mouse
13	INT from co-processor
14	Primary IDE
15	Secondary IDE

\* Ethernet interface IRQ select: 9, 11, 12

\* PnP audio IRQ select: 9, 11, 12

\* PnP USB IRQ select: 9, 11, 12

## **DOC<sup>®</sup> 2000 Installation Guide**

This appendix contains information on the DiskOnChip<sup>®</sup> 2000 quick installation guide. It includes:

- DiskOnChip<sup>®</sup> 2000 installation instructions
- Additional information and assistance

# DiskOnChip® 2000 Quick Installation Guide

---

## DiskOnChip® 2000 installation instructions

1. Make sure the target platform is powered OFF.
2. Plug the DiskOnChip® 2000 device into its socket. Verify the direction is correct (pin 1 of the DiskOnChip® 2000 is aligned with pin 1 of the socket).
3. Power up the system.
4. During power up you may observe the messages displayed by the DiskOnChip® 2000 when its drivers are automatically loaded into the system's memory.
5. At this stage the DiskOnChip® 2000 can be accessed as any disk in the system.
6. If the DiskOnChip® 2000 is the only disk in the system, it will appear as the first disk (drive C: in DOS).
7. If there are more disks besides the DiskOnChip 2000, the DiskOnChip® 2000 will appear by default as the last drive, unless it was programmed as the first drive. (Please refer to the DiskOnChip® 2000 utilities user manual.)
8. If you want the DiskOnChip® 2000 to be bootable:
  - a. Copy the operating system files into the DiskOnChip® by using the standard DOS command (for example: sys d:).
  - b. The DiskOnChip® should be the only disk in the systems or would be configured as the first disk in the system (c:) using the DUPDATE utility.

```
DUPDATE D /S: DOC104.EXB /FIRST (set as c:)
DUPDATE C /S: DOC104.EXB (set as d:)
```

## **Additional information and assistance**

1. Visit M-Systems' web site at [www.m-sys.com](http://www.m-sys.com) where you can find a Utilities Manual, Data Sheet and Application Notes. In addition, you can find the latest DiskOnChip® 2000 S/W Utilities.
2. Contact your dealer for technical support if you need additional assistance, and have the following information ready:
  - Product name and serial number.
  - Description of your computer hardware (manufacturer, model, attached devices, etc.)
  - Description of your software (operating system, version, application software, etc.)
  - A complete description of the problem.
  - The exact wording of any error messages.



## POS-562/562L User's Note

---

1. POS-562/562L has very powerful functions, so when using IRQs, take special care. If you would like to use extra add-on cards, please make sure that the IRQs do not conflict.

### IRQ Table

IRQ-00	Systems timer
IRQ-01	Standard 101/102 keyboard
IRQ-02	Programmable interrupt controller
IRQ-03	COM2
IRQ-04	COM1
IRQ-05	Realtek RTL8029 PCI/Ethernet
IRQ-06	Floppy controller
IRQ-07	LPT1
IRQ-08	RTC
IRQ-09	COM4
IRQ-10	COM3
IRQ-11	LPT2
IRQ-12	PS/2 mouse
IRQ-13	Floating point processor
IRQ-14	Primary IDE controller
IRQ-15	Secondary IDE controller

2. Our R&D unit has found that DIMM modules may have some compatibility problems. Currently, the following modules have been approved (updates will be provided in the future).
  - NEC (Japan)
  - Mitsubishi
3. DIMM and SIMM modules should not be used concurrently. Such use could lead to instability.