



User Manual

AIMB-288E

**1U THIN Motherboard 12th Gen
Intel[®] Core[™] Processor
LGA1700 NVIDIA[®] Quadro[®]
Embedded T1000**

ADVANTECH

Enabling an Intelligent Planet

Copyright

The documentation and the software included with this product are copyrighted 2023 by Advantech Co., Ltd. All rights are reserved. Advantech Co., Ltd. reserves the right to make improvements in the products described in this manual at any time without notice. No part of this manual may be reproduced, copied, translated, or transmitted in any form or by any means without the prior written permission of Advantech Co., Ltd. The information provided in this manual is intended to be accurate and reliable. However, Advantech Co., Ltd. assumes no responsibility for its use, nor for any infringements of the rights of third parties that may result from its use.

Acknowledgments

IBM and PC are trademarks of International Business Machines Corporation. Intel® Core™ i9/i7/i5/i3, Pentium®, and Celeron® are trademarks of the Intel Corporation. All other product names or trademarks are properties of their respective owners.

Product Warranty (2 years)

Advantech warrants the original purchaser that each of its products will be free from defects in materials and workmanship for two years from the date of purchase.

This warranty does not apply to any products that have been repaired or altered by persons other than repair personnel authorized by Advantech, or products that have been subject to misuse, abuse, accident, or improper installation. Advantech assumes no liability under the terms of this warranty as a consequence of such events.

Because of Advantech's high quality-control standards and rigorous testing, most customers never need to use our repair service. If an Advantech product is defective, it will be repaired or replaced free of charge during the warranty period. For out-of-warranty repairs, customers will be billed according to the cost of replacement materials, service time, and freight. Please consult your dealer for more details.

If you believe your product to be defective, follow the steps outlined below.

1. Collect all the information about the problem encountered. (For example, CPU speed, Advantech products used, other hardware and software used, etc.) Note anything abnormal and list any onscreen messages displayed when the problem occurs.
2. Call your dealer and describe the problem. Please have your manual, product, and any helpful information readily available.
3. If your product is diagnosed as defective, obtain a return merchandise authorization (RMA) number from your dealer. This allows us to process your return more quickly.
4. Carefully pack the defective product, a completed Repair and Replacement Order Card, and a proof of purchase date (such as a photocopy of your sales receipt) into a shippable container. Products returned without a proof of purchase date are not eligible for warranty service.
5. Write the RMA number clearly on the outside of the package and ship the package prepaid to your dealer.

A Message to the Customer

Advantech Customer Services

Each and every Advantech product is built to the most exacting specifications to ensure reliable performance in the harsh and demanding conditions typical of industrial environments. Whether your new Advantech equipment is destined for the laboratory or the factory floor, you can be assured that your product will provide the reliability and ease of operation for which the name Advantech has come to be known. Your satisfaction is our primary concern. Here is a guide to Advantech's customer services. To ensure you get the full benefit of our services, please follow the instructions below carefully.

Technical Support

We want you to get the maximum performance from your products. So if you run into technical difficulties, we are here to help. For the most frequently asked questions, you can easily find answers in your product documentation. These answers are normally a lot more detailed than the ones we can give over the phone.

So please consult this manual first. If you still cannot find the answer, gather all the information or questions that apply to your problem, and with the product close at hand, call your dealer. Our dealers are well trained and ready to give you the support you need to get the most from your Advantech products. In fact, most problems reported are minor and are able to be easily solved over the phone.

In addition, free technical support is available from Advantech engineers every business day. We are always ready to give advice on application requirements or specific information on the installation and operation of any of our products.

Declaration of Conformity

FCC Class B

This equipment has been tested and found to comply with the limits for a Class B digital device, pursuant to part 15 of the FCC Rules. These limits are designed to provide reasonable protection against harmful interference in a residential installation. This equipment generates, uses, and can radiate radio frequency energy and, if not installed and used in accordance with the instruction manual, may cause harmful interference to radio communications. However, there is no guarantee that interference will not occur in a particular installation. If this equipment does cause harmful interference to radio or television reception, which can be determined by turning the equipment off and on, the user is encouraged to try to correct the interference by one or more of the following measures:

- Reorient or relocate the receiving antenna.
- Increase the separation between the equipment and receiver.
- Connect the equipment into an outlet on a circuit different from that to which the receiver is connected.
- Consult the dealer or an experienced radio/TV technician for assistance.

CPU Compatibility

Processor Number	Max_TDP	Code Name	Cores/Threads	S-Spec
i9-12900	65W	Alder Lake	8P+8E/24T	SRL4K
i9-12900E	65W	Alder Lake	8P+8E/24T	QYMF
i9-12900TE	35W	Alder Lake	8P+8E/24T	SRL6C
i7-12700	65W	Alder Lake	4P+8E/20T	SRL4Q
i7-12700E	65W	Alder Lake	8P+8E/24T	SRL6D
i7-12700TE	35W	Alder Lake	8P+8E/24T	SRL6E
i5-12500	65W	Alder Lake	6P+6E/12T	SRL5V
i5-12500E	65W	Alder Lake	6P+6E/12T	SRL6W
i5-12500TE	35W	Alder Lake	6P+6E/12T	SRL6V
i5-12400	65W	Alder Lake	6P+6E/12T	SRL5Y
i3-12100	60W	Alder Lake	4P+4E/8T	SRL62
i3-12100E	60W	Alder Lake	4P+4E/8T	SRL6U
i3-12100TE	35W	Alder Lake	4P+4E/8T	SRL6T
G7400E	46W	Alder Lake	2P+2E/4T	SRL6R
G7400TE	35W	Alder Lake	2P+2E/4T	SRL6S
G6900E	46W	Alder Lake	2P+2E/4T	SRL6Q
G6900TE	35W	Alder Lake	2P+2E/2T	SRL6P

Memory Compatibility

Category	Speed	Capacity	Vendor	Chip P/N	ADVANTECH P/N	ECC
DDR5	4800	32 GB	Advantech	IVA45 D8BNJ	SQR-SD5N32G4K8MNAB	N
DDR5	4800	16 GB	Advantech	2AA45 D8BNJ	SQR-SD5N16G4K8MNAB	N

M.2 SSD Compatibility

Dimension	Interface	Bandwidth Performance	Vendor Category	Vendor	Model	ADVANTECH P/N
2280	M.2 Key B+M	PCIe v3.1	NVMe PCIe SSD	Advantech	SQF-C8BV4-2TDEDC	SQF-C8BV4-2TDEDC
2242	M.2 Key M	PCIe v3.1	NVMe PCIe SSD	Advantech	SQF-C4MV4-2TDEDC	SQF-C4MV4-2TDEDC
2280	M.2 Key B+M	SATA3	SSD	Advantech	SQF-SM8V4-1TCSBC	SQF-SM8V4-1TCSBC
2280	M.2 Key M	PCIe v3.0	NVMe PCIe SSD	WD	WDSN850500GBP-CleM.2SSD	N/A
2260	M.2 Key B+M	SATA3	SSD	Advantech	SQF-SM8V4-1K9GD-SCC	SQF-SM8V4-1K9GD-SCC
2280	M.2 Key B+M	SATA3	SSD	Advantech	SQF-S8BV4-2TDSDC	SQF-S8BV4-2TDSDC
2242	M.2 Key B+M	SATA3	SSD	Advantech	SQF-SM4Z2-128GCSBE	SQF-SM4Z2-128GCSBE
2242	M.2 Key B+M	SATA3	SSD	Advantech	SQF-SM4Z2-128GCSBC	SQF-SM4Z2-128GCSBC
2280	M.2 Key B+M	SATA3	SSD	Advantech	SQF-SM8Z4-256GCSBE	SQF-SM8Z4-256GCSBE
2280	M.2 Key M	PCIe v3.1	NVMe PCIe SSD	Advantech	SQF-C8MV4-2TCEDC	SQF-C8MV4-2TCEDC
3042	M.2 Key B	USB 3.1 Gen1	4G LTE	Sierra Wireless	EM7455	N/A

Ordering Information

P/N	GPU	DP	eDP	GbE	COM	SATA3	USB3	M.2 M-Key	M.2 B-Key	TPM 2.0	AMP
AIMB-288EH-00A1	Nvidia T1000 (w/ Cooler)	2	1	2	2	1	6	1	1	1	(0)

P/N	GPU	GPU	Memory	Storage	DP	GbE	COM	SATA3	USB3	M.2 B-Key	TPM 2.0	Cooler
AIMB-288EH-K1A1	I3-12100E	Nvidia T1000	32 GB DDR5	512G NVMe	2	2	2	1	6	1	1	THIN Cooler

* () is not populated when MP.

Initial Inspection

Before you begin installing your motherboard, please make sure that the following materials have been shipped:

- 1 x AIMB-288E Intel® LGA1700 Core™ i9/i7/i5/i3 THIN AI motherboard
- 1 x SATA HDD cable
- 1-to-2 serial port cables, 22 cm
- 1 x SATA power cable
- 1 x I/O port bracket
- 1 x startup manual
- 1 x warranty card

If any of these items are missing or damaged, contact your distributor or sales representative immediately. We have carefully inspected the AIMB-288E mechanically and electrically before shipment. It should be free of marks and scratches and in perfect working order upon receipt. As you unpack the AIMB-288E, check it for signs of shipping damage. (For example, damaged box, scratches, dents, etc.) If it is damaged or it fails to meet the specifications, notify our service department or your local sales representative immediately. Also notify the carrier. Retain the shipping carton and packing material for inspection by the carrier. After inspection, we will make arrangements to repair or replace the unit.

Contents

Chapter 1 General Introduction1

1.1	Introduction	2
1.2	Features	2
1.3	Specifications	2
1.3.1	System	2
1.3.2	Memory	2
1.3.3	Input/Output	2
1.3.4	Graphics	2
1.3.5	Ethernet LAN	3
1.3.6	Industrial Features	3
1.3.7	Mechanical and Environmental Specifications	3
1.4	Jumpers and Connectors	4
	Table 1.1: Connector and Header List	4
1.5	Board Layout: Jumper and Connector Locations	5
	Figure 1.1 Jumper and Connector Locations (Top Side)	5
	Figure 1.2 Jumper and Connector Locations (Bottom Side)	5
1.6	AIMB-288E Board Diagram	6
	Figure 1.3 AIMB-288E Board Diagram	6
1.7	Safety Precautions	6
1.8	Jumper Settings	7
1.8.1	How to Set Jumpers	7
1.8.2	Clear CMOS (JCMOS1)	7
	Table 1.2: CMOS1	7
1.8.3	Watchdog Timer Output and OBS Beep (JWDT1+JOBS1)	8
	Table 1.3: Watchdog Timer Output and OBS Beep (JWDT1+JOBS1)	8
1.8.4	ATX/AT Mode Selection (PSON1)	8
	Table 1.4: ATX/AT Mode Selection (PSON1)	8
1.8.5	eDP Panel Voltage Selection (JLVDS1)	8
	Table 1.5: eDP Panel Voltage Selection (JLVDS1)	8
1.8.6	COM1 RI# Pin RI# / 5V/12V Select (JSETCOM1_V1)	9
	Table 1.6: COM1 RI# Pin RI# / 5V/12V Select (JSETCOM1_V1)	9
1.9	System Memory	9
1.10	Memory Installation Procedures	9
1.11	Cache Memory	9
1.12	Processor Installation	10

Chapter 2 Connecting Peripherals11

2.1	Introduction	12
2.2	DC Input Connector (DCIN1)	12
2.3	DisplayPort Connector #1 / #2 (DP12)	12
2.4	LAN1/2 (RJ-45)	13
2.5	USB 3.1 Gen1 1/2/3/4 (USB12/34)	13
2.6	HD Audio Interface (Line-Out) (Audio1)	14
2.7	Front Panel Audio Header (JFPAUD1)	14
2.8	Amplifier Connector (AMP1)	15
2.9	USB 3.1 Gen1 5/6 (USB56)	15
2.10	Serial ATA Interface Connector #1 (SATA1)	15
2.11	Serial ATA Interface Power Connector (SATAPWR1)	16
2.12	Embedded DisplayPort Connector (EDP1)	16
2.13	EDP Backlight Inverter Power Connector (INV1)	16
2.14	NGFF M.2 M-Key Connector for 2280 Module (M2M1)	17
2.15	NGFF M.2 E-Key Connector for 3042 Module (M2B1)	18

2.16	MXM Connector (MXM1)	19
2.17	COM Port Pin Header #1/#2 (COM12)	22
2.18	DDR5 SODIMM Socket A1 / B1 (DIMMA1/B1).....	23
2.19	CPU FAN Connector (CPUFAN1)	23
2.20	System Fan #1 Connector / System Fan #2 Connector (SYSFAN1/2)...	23
2.21	SIM Card Socket (SIM1)	24
2.22	LED Port 80 Connector (LED_P80).....	24
2.23	Voltage Selection for EDP1 Connector (JEDP1)	25
2.24	CMOS Battery Connector (BAT1).....	25
2.25	RTC Reset Pin Header (JCMOS1)	25
2.26	PWRBTN# / RESET# / HDD LED / SM bus (JFP1).....	25
2.27	Power LED Pin Header (JFP2)	26
2.28	AT/ATX Mode Selection (PSON1).....	26
Chapter 3	BIOS Operation	27
3.1	Introduction	28
3.2	BIOS Setup	28
3.2.1	Main Menu	29
3.2.2	Advanced BIOS Features	30
3.2.3	Chipset Configuration Setting	54
3.2.4	Security.....	69
3.2.5	Boot Settings	70
3.2.6	Save & Exit Configuration.....	71
Chapter 4	Software Introduction & Service	73
4.1	Introduction	74
4.2	Value-Added Software Services	74
4.2.1	Software API.....	74
4.2.2	Software Utility.....	76
Chapter 5	Chipset Software Installation Utility	77
5.1	Before You Begin.....	78
5.2	Introduction	78
Chapter 6	VGA Setup	79
6.1	Introduction	80
6.2	Windows 10 T1000 Driver Installation	80
Chapter 7	LAN Configuration	81
7.1	Introduction	82
7.2	Features	82
7.3	Installation.....	82
7.4	Windows® 10 Driver Setup (Intel® i219LM & Intel® i226V)	83

Chapter 1

General Introduction

1.1 Introduction

AIMB-288E is designed with the Intel® H610E PCH and NVIDIA Quadro GPU to accelerate edge AI deployment. The motherboard supports Intel® desktop Core i9/i7/i5/i3/Pentium®/Celeron® processors, up to 30 MB SmartCache, and 2 x DDR5 4800MHz SODIMM, up to 64 GB in two 262-pin SODIMM sockets. Multiple I/O connectivity of 2 x serial ports, 6 x USB 3.2 (Gen1), 2 x GbE LAN, 1 x SATA III, 1 x M.2 B-Key and 1 x M.2 M-Key connectors are also supported.

1.2 Features

- **I/O connectivity:** 2 x serial ports, 6 x USB 3.2 (Gen1), 1 x SATA III, 1 M.2 B-Key & 1 M.2 M-Key, 2 GbE LAN.
- **Industrial motherboard features NVIDIA Quadro GPU:** The AIMB-288E leverages an ultra-slender design to deliver outstanding computing power and superior graphics performance to visual computing in edge intelligence.
- **Wide selection of storage devices:** SATA HDD, M.2 (B-Key and M-Key), customers benefit from the flexibility of using the most suitable storage device for larger capacity.
- **Chipset for data processing:** Discrete GPU through MXM module, supports NVIDIA® Quadro® Embedded T1000.

1.3 Specifications

1.3.1 System

- **CPU:** LGA1700 Intel® desktop Core™ i9/i7/i5/i3/Pentium®/Celeron® processor compliant
- **BIOS:** AMI EFI 256 Mbit SPI BIOS.
- **System chipset:** Intel® H610E.
- **SATA hard disk drive interface:**
 - One on-board SATA connector with data transmission rate up to 600 MB/s
 - One M.2 M-Key slot (2280), supports NVMe SSD
 - One M.2 B-Key slot (3042/2242), supports 4G/LTE and storage.

1.3.2 Memory

- **RAM:** 2 x 262-pins SODIMM socket support dual channel DDR5 4800MHz SDRAM, up to 64 GB Max.

1.3.3 Input/Output

- **Serial ports:** Two serial ports support 2 x RS-232. (RS-422/485 support by BOM option.).
- **USB port:** Supports up to six USB 3.2 (Gen 1) ports.
- **GPIO connector:** 8-bit general purpose Input/Output.

1.3.4 Graphics

- **Chipset for data processing:** Intel® Iris® Xe graphics.
- **eDP1.4:** Supports max. resolution 3840 x 2160 @ 60Hz.
- **DP1.4:** Supports max. resolution 4096 x 2160 @ 60Hz.

1.3.5 Ethernet LAN

- Supports dual 10/100/1000 Mbps Ethernet port (s) via PCI Express x1 bus which provides 500 MB/s data transmission rates.
- **Controller:**
 - GbE LAN1: Intel® i219LM
 - GbE LAN2: Intel® i226V

1.3.6 Industrial Features

- Watchdog timer: It can generate a system reset. The watchdog timer is programmable, with each unit equal to one second or one minute (255 levels).

1.3.7 Mechanical and Environmental Specifications

- **Operating temperature:** 0 ~ 60 °C (32 ~ 140 °F, with 1U cooler).
- **Storage temperature:** -40 ~ 85 °C (-40 ~ 185 °F).
- **Humidity:** 5 ~ 95% non-condensing.
- **Power supply voltage:** +24V ~ +19V
- **Power consumption:**
Intel® Core™ i9-12900E 5.0 GHz, 2 pcs 32 GB DDR5 4800 MHz SDRAM
Typical: 104 W; Turbo: 135 W (CPU+T000 GPU).
Measure the maximum current value which system under maximum load (CPU: Top speed, RAM & Graphics: Full loading).
- **Board size:** 170 mm x 190 mm (6.69" x 7.48").
- **Board weight:** 0.365 kg.

1.4 Jumpers and Connectors

Connectors on the AIMB-288E motherboard link it to devices such as hard disk drives and a keyboard. In addition, the board has a number of jumpers used to configure the system for your application.

The tables below list the function of each of the board jumpers and connectors. Later sections in this chapter give instructions on setting jumpers. Chapter 2 gives instructions for connecting external devices to your motherboard.

Table 1.1: Connector and Header List

	Description	Part Reference
1	Direct Current input connector	DCIN1
2	DisplayPort connector #1 / #2	DP12
3	RJ-45 #1 / #2	LAN12
4	USB 3.1 Gen1 Connector #1 / #2	USB12
5	USB 3.1 Gen1 Connector #3 / #4	USB34
6	HD Audio Interface (Line-Out)	AUDIO1
7	Front panel audio header	JFPAUD1
8	Amplifier connector	AMP1
9	USB 3.1 Gen1 pin header #5 / #6	USB56
10	Serial ATA interface connector #1	SATA1
11	Serial ATA interface power connector	SATAPWR1
12	Embedded DisplayPort connector	eDP1
13	EDP Backlight inverter power connector	INV1
14	NGFF M.2 M-Key connector for 2280 module	M2M1
15	NGFF M.2 B-Key connector for 3042 module	M2B1
16	MXM connector	MXM1
17	COM port pin header #1 / #2	COM12
18	DDR5 SODIMM socket A1 / B1	DIMMA1/B1
19	CPU FAN connector	CPUFAN1
20	System Fan #1 connector / System Fan #2 connector	SYSFAN1/2
21	SIM card socket	SIM1
22	LED port 80 connector	LED_P80
23	Voltage selection for EDP1 connector	JEDP1
24	CMOS battery connector	BAT1
25	RTC reset pin header	JCMOS1
26	PWRBTN# / RESET# /HDD LED / SM bus	JFP1
27	Power LED pin header	JFP2
28	AT/ATX Mode selection	PSON1

1.5 Board Layout: Jumper and Connector Locations

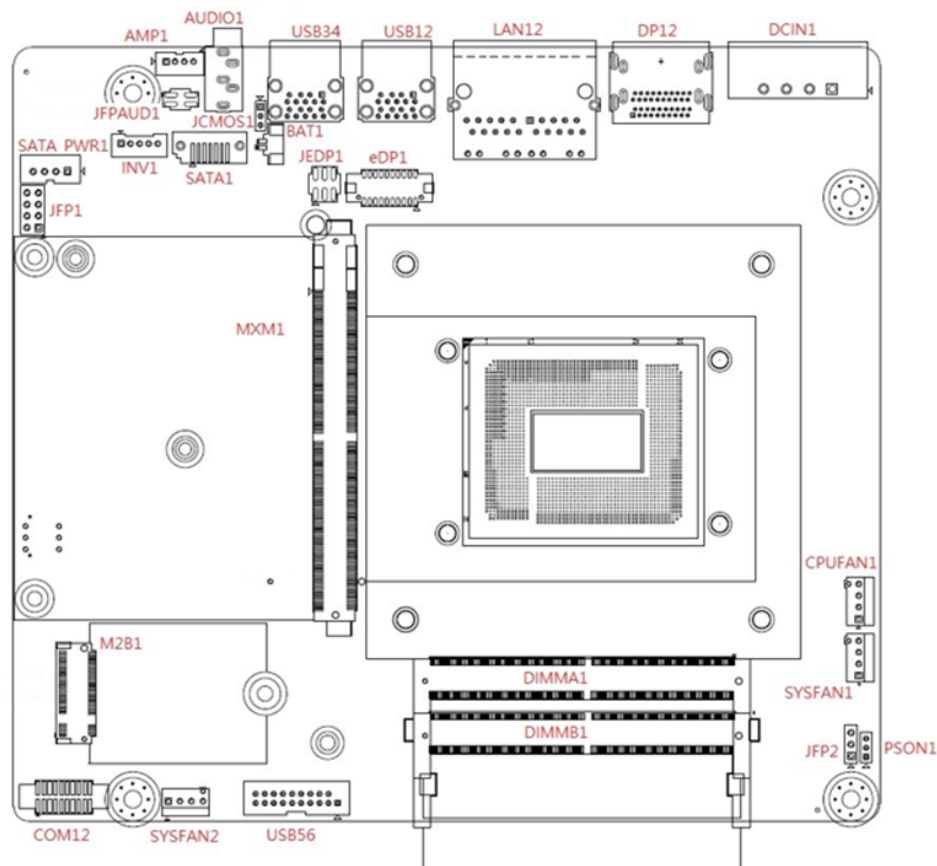

Figure 1.1 Jumper and Connector Locations (Top Side)

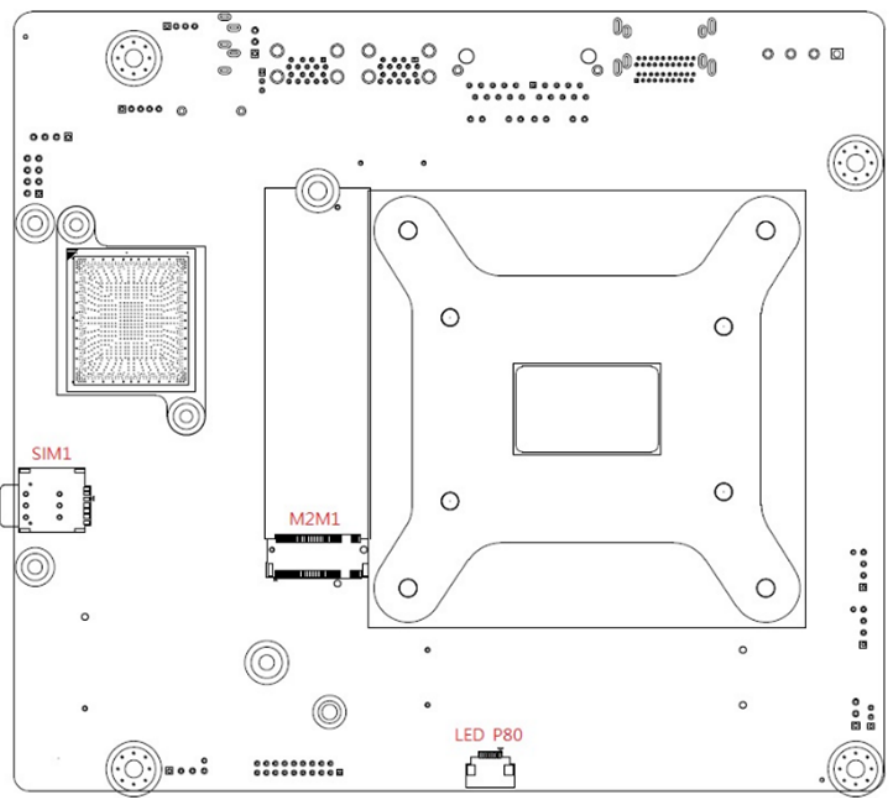

Figure 1.2 Jumper and Connector Locations (Bottom Side)

1.6 AIMB-288E Board Diagram

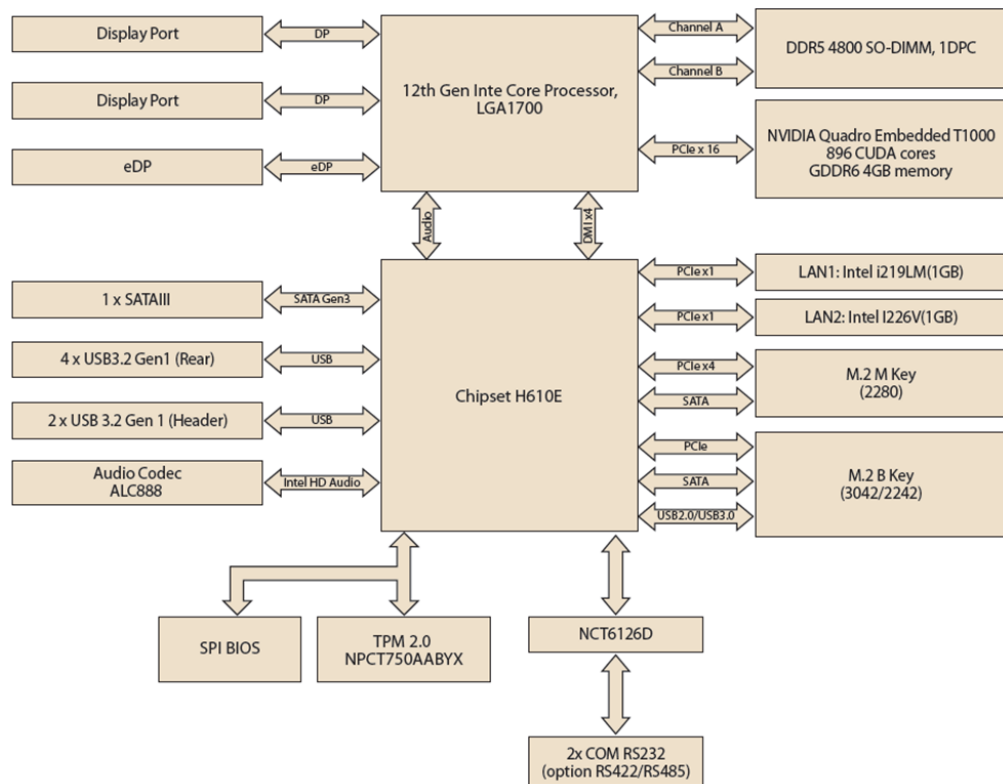

Figure 1.3 AIMB-288E Board Diagram

1.7 Safety Precautions

Warning! Always completely disconnect the power cord from the chassis whenever you work with the hardware. Do not make connections while the power is on. Sensitive electronic components can be damaged by sudden power surges. Only experienced electronics personnel should open the PC chassis.



Caution! Always ground yourself to remove any static charge before touching the motherboard. Modern electronic devices are very sensitive to electrostatic discharges. As a safety precaution, use a grounding wrist strap at all times. Place all electronic components on a static-dissipative surface or in a static-shielded bag when they are not in the chassis.



Caution! The computer is provided with a battery-powered real-time clock circuit. There is a danger of explosion if the battery is incorrectly replaced. Replace only with the same or equivalent type recommended by the manufacturer. Discard used batteries according to the manufacturer's instructions.



Caution! *There is a danger of a new battery exploding if it is incorrectly installed. Do not attempt to recharge, force open, or heat the battery. Replace the battery only with the same or equivalent type recommended by the manufacturer. Discard used batteries according to the manufacturer's instructions.*



1.8 Jumper Settings

This section provides instructions on how to configure your motherboard by setting the jumpers. It also includes the motherboard's default settings and your options for each jumper.



1.8.1 How to Set Jumpers

You can configure your motherboard to match the needs of your application by setting the jumpers. A jumper is a metal bridge that closes an electrical circuit. It consists of two metal pins and a small metal clip (often protected by a plastic cover) that slides over the pins to connect them. To "close" (or turn ON) a jumper, you connect the pins with the clip. To "open" (or turn OFF) a jumper, you remove the clip. Sometimes a jumper consists of a set of three pins, labeled 1, 2, and 3. In this case you connect either pins 1 and 2, or 2 and 3. A pair of needle-nose pliers may be useful when setting jumpers.

1.8.2 Clear CMOS (JCMOS1)

The AIMB-288E motherboard contains a jumper that can erase CMOS data and reset the system BIOS information. Normally this jumper should be set with pins 1-2 closed. If you want to reset the CMOS data, set CMOS1 to 2-3 closed for just a few seconds, and then move the jumper back to 1-2 closed. This procedure will reset the CMOS to its default setting.

Table 1.2: CMOS1

Function	Jumper Settings
Keep CMOS data (Default)	<div style="text-align: center;"> 1 2 3  1-2 </div>
Clear CMOS data	<div style="text-align: center;"> 1 2 3  2-3 </div>

1.8.3 Watchdog Timer Output and OBS Beep (JWDT1+JOBS1)

Table 1.3: Watchdog Timer Output and OBS Beep (JWDT1+JOBS1)

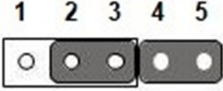
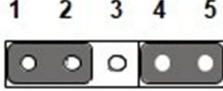
Function	Jumper Setting
Watchdog Timer Output (2-3) OBS BEEP(4-5) (Default)	 <p>(2 and 3)+(4 and 5)</p>
Watchdog Timer Disable (1-2) OBS BEEP(4-5) (Default)	 <p>(1 and 2)+(4 and 5)</p>

1.8.4 ATX/AT Mode Selection (PSON1)

Table 1.4: ATX/AT Mode Selection (PSON1)

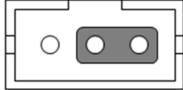
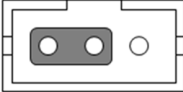
Function	Jumper Setting
AT Mode	 <p>1 2 3</p>
ATX Mode (Default)	 <p>1 2 3</p>

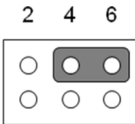
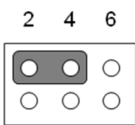
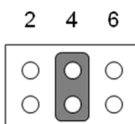

1.8.5 eDP Panel Voltage Selection (JLVDS1)

Table 1.5: eDP Panel Voltage Selection (JLVDS1)

Function	Jumper Setting
Jumper position for +3.3V (Default)	 <p>2 4 6</p> <p>1 3 5</p>
Jumper position for +5V	 <p>2 4 6</p> <p>1 3 5</p>
Jumper position for +12V	 <p>2 4 6</p> <p>1 3 5</p>

1.8.6 COM1 RI# Pin RI# / 5V/12V Select (JSETCOM1_V1)

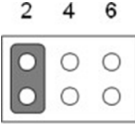
Table 1.6: COM1 RI# Pin RI# / 5V/12V Select (JSETCOM1_V1)

Function	Jumper Setting
Jumper position for RI# (default)	 <p>2 4 6</p> <p>1 3 5</p>
Jumper position for +5V	 <p>2 4 6</p> <p>1 3 5</p>
Jumper position for +12V	 <p>2 4 6</p> <p>1 3 5</p>

1.9 System Memory

AIMB-288E has two sockets for a 262-pin DDR5 SODIMM. These sockets use a 1.2 V unbuffered double data rate synchronous DRAM (DDR SDRAM). DRAM is available in capacities of 4 GB, 8 GB, 16 GB, and 32 GB. The sockets can take any combination with SODIMMs of any size, giving a total memory size between 4 GB, 8 GB, 16 GB, and up to a max of 64 GB. AIMB-288E does NOT support error checking and correction (ECC).

1.10 Memory Installation Procedures

To install SODIMMs, first make sure the two handles of the SODIMM socket are in the “open” position, i.e., the handles lean outward. Slowly slide the SODIMM module along the plastic guides on both ends of the socket. Then firmly but gently (avoid pushing down too hard) press the SODIMM module well down into the socket, until you hear a click when the two handles have automatically locked the memory module into the correct position of the SODIMM socket. To remove the memory module, just push both handles outward, and the memory module will be ejected by the mechanism.

1.11 Cache Memory

The AIMB-288E supports a CPU with one of the following built-in full-speed last level caches:

30 MB for Intel® Core™ i9-12900E/i9-12900TE 25 MB for Intel® Core™ i7-12700E/i7-12700TE 18 MB for Intel® Core™ i5-12500E/i7-12500TE 12 MB for Intel® Core™ i3-12100E/i7-12100TE 2.5 MB Pentium® G7400E/G7400TE

The built-in second-level cache in the processor yields much higher performance than conventional external cache memory.

1.12 Processor Installation

The AIMB-288E is designed to support 12th Gen Intel® LGA1700, Core™ i9/Core™ i7/ Core™ i5/Core™ i3, Pentium®, Celeron® processors.

Chapter 2

Connecting
Peripherals

2.1 Introduction

You can access most of the connectors from the top of the board as it is being installed in the chassis. If you have a number of cards installed or have a packed chassis, you may need to partially remove the card to make all the connections.

2.2 DC Input Connector (DCIN1)

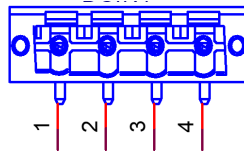

Pin	Signal
1	GND
2	19V ~ 24V
3	19V ~ 24V
4	GND

2.3 DisplayPort Connector #1 / #2 (DP12)

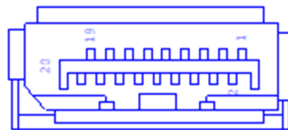

Pin	Signal	Pin	Signal
1	D0+	2	GND
3	D0-	4	D1+
5	GND	6	D1-
7	D2+	8	GND
9	D2-	10	D3+
11	GND	12	D3-
13	DP_AUX_E#	14	GND
15	AUX+	16	GND
17	AUX-	18	HPD
19	GND	20	+3.3V

2.4 LAN1/2 (RJ-45)

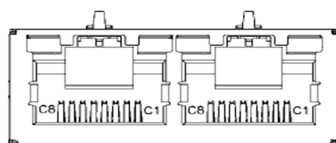

Pin	Signal
C1	MDI0+
C2	MDI0-
C3	MDI1+
C4	MDI2+
C5	MDI2-
C6	MDI1-
C7	MDI3+
C8	MDI3-

2.5 USB 3.1 Gen1 1/2/3/4 (USB12/34)

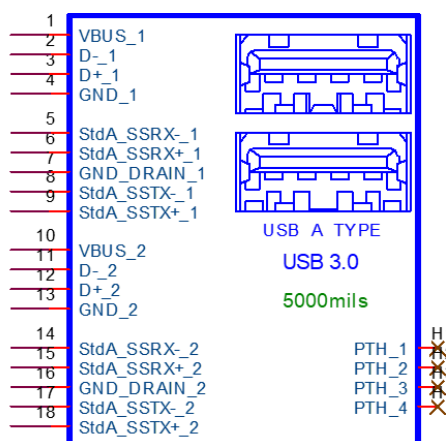

Pin	Signal	Pin	Signal
1	VBUS	10	VBUS
2	D1-	11	D2-
3	D1+	12	D2+
4	GND	13	GND
5	RX1-	14	RX2-
6	RX1+	15	RX2+
7	GND	16	GND
8	TX1-	17	TX2-
9	TX1+	18	TX2+

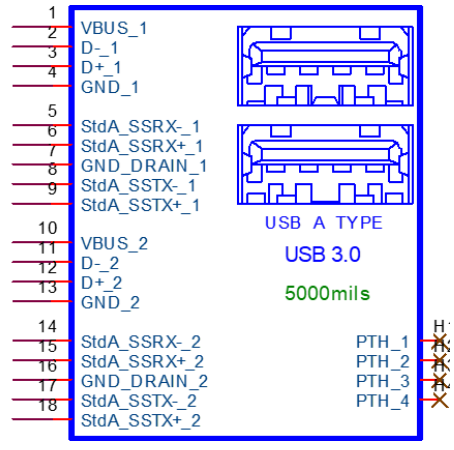

Pin	Signal	Pin	Signal
1	VBUS	10	VBUS
2	D1-	11	D2-
3	D1+	12	D2+
4	GND	13	GND
5	RX1-	14	RX2-
6	RX1+	15	RX2+
7	GND	16	GND
8	TX1-	17	TX2-
9	TX1+	18	TX2+

2.6 HD Audio Interface (Line-Out) (Audio1)

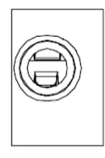

Pin	Signal
1	LINE OUT - L
2	LINE OUT - R

2.7 Front Panel Audio Header (JFPAUD1)

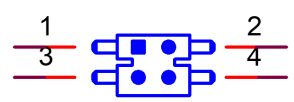

Pin	Signal	Pin	Signal
1	MIC-L	2	MIC-R
3	AGND	4	Jack Detect

2.8 Amplifier Connector (AMP1)

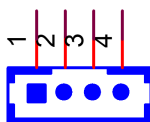

Pin	Signal
1	R+
2	R-
3	L-
4	L+

2.9 USB 3.1 Gen1 5/6 (USB56)

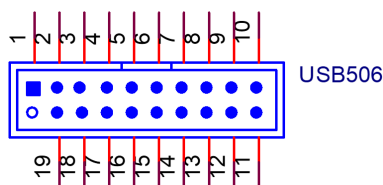

Pin	Signal	Pin	Signal
1	VBUS	11	D2+
2	RX1-	12	D2-
3	RX1+	13	GND
4	GND	14	TX2+
5	TX1-	15	TX2-
6	TX1+	16	GND
7	GND	17	RX2+
8	D1-	18	RX2-
9	D1+	19	VBUS
10	NC		

2.10 Serial ATA Interface Connector #1 (SATA1)

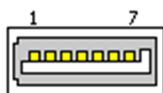

Pin	Signal
1	GND
2	TX+
3	TX-
4	GND
5	RX-
6	RX+
7	GND

2.11 Serial ATA Interface Power Connector (SATAPWR1)

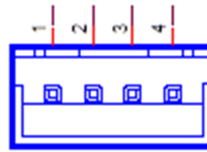

Pin	Signal
1	+5V
2	GND
3	GND
4	+12V

2.12 Embedded DisplayPort Connector (EDP1)

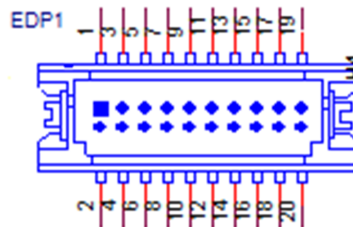

Pin	Signal	Pin	Signal
1	GND	2	GND
3	TX0-	4	TX3-
5	TX0+	6	TX3+
7	GND	8	NC
9	TX1-	10	GND
11	TX1+	12	AUX-
13	GND	14	AUX+
15	TX2-	16	GND
17	TX2+	18	HPD
19	+VDD_EDP	20	+VDD_EDP

2.13 EDP Backlight Inverter Power Connector (INV1)

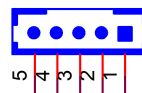

Pin	Signal
1	+V12
2	GND
3	Enable backlight
4	Brightness control
5	+V5

2.14 NGFF M.2 M-Key Connector for 2280 Module (M2M1)

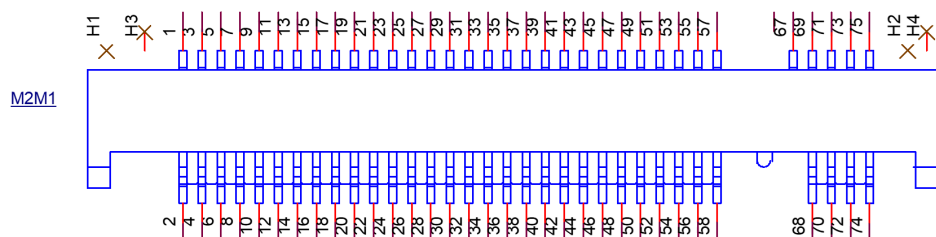

Pin	Signal	Pin	Signal
1	GND	2	+3.3V
3	GND	4	+3.3V
5	PCIE_RX-	6	NC
7	PCIE_RX+	8	NC
9	GND	10	NC
11	PCIE_TX-	12	+3.3V
13	PCIE_TX+	14	+3.3V
15	GND	16	+3.3V
17	PCIE_RX-	18	+3.3V
19	PCIE_RX+	20	NC
21	GND	22	NC
23	PCIE_TX-	24	NC
25	PCIE_TX+	26	NC
27	GND	28	NC
29	PCIE_RX-	30	NC
31	PCIE_RX+	32	NC
33	GND	34	NC
35	PCIE_TX-	36	NC
37	PCIE_TX+	38	DEVSLP
39	GND	40	NC
41	PCIE_RX0- / SATA_RX+	42	NC
43	PCIE_RX0+ / SATA_RX-	44	NC
45	GND	46	NC
47	PCIE_TX0- / SATA_TX-	48	NC
49	PCIE_TX0+ / SATA_TX+	50	PLTRST#
51	GND	52	CLKREQ#
53	PCIE_CLK-	54	PCIEWAKE#
55	PCIE_CLK+	56	NC
57	GND	58	NC
	KEY		KEY
67	NC	68	SUSCLK
69	SATA/PCIE DETECT	70	+3.3V
71	GND	72	+3.3V
73	GND	74	+3.3V
75	GND		

2.15 NGFF M.2 E-Key Connector for 3042 Module (M2B1)

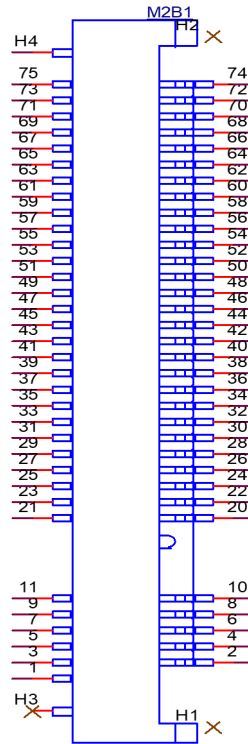

Pin	Signal	Pin	Signal
1	CFG3	2	+3.3V
3	GND	4	+3.3V
5	GND	6	FULL_CARD_OFF#
7	USB_D+	8	W_DISABLE1#
9	USB_D-	10	LED1#
11	GND		KEY
	KEY	20	NC
21	CFG0	22	NC
23	WAKE_WWAN#	24	NC
25	DPR	26	W_DISABLE2#
27	GND	28	NC
29	USB3_RX-	30	UIM_RESET
31	USB3_RX+	32	UIM_CLK
33	GND	34	UIM_DATA
35	USB3_TX-	36	UIM_PWR
37	USB3_TX+	38	DEVSLP
39	GND	40	NC
41	PCIERX- / SATARX+	42	NC
43	PCIERX+/SATARX-	44	NC
45	GND	46	NC
47	PCIE_CLK-	48	NC
49	PCIE_CLK+	50	PLTRST#

51	GND	52	CLKREQ#
53	PCIE_CLKREQ#	54	PCIE_WAKE#
55	PCIE_WAKE#	56	NC
57	GND	58	NC
59	LAA_TXEN	60	NC
61	NC	62	WLAN_TXEN
63	NC	64	NC
65	NC	66	SIMDET
67	RESET#	68	SUSCLK
69	CFG1	70	+3.3V
71	GND	72	+3.3V
73	GND	74	+3.3V
75	CFG2		

2.16 MXM Connector (MXM1)

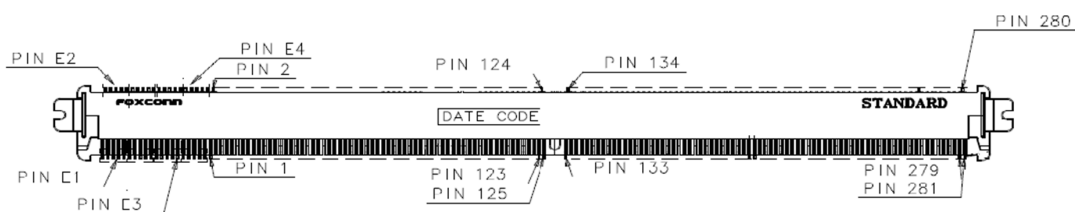

Pin	Signal	Pin	Signal
E1	+12V	E2	+12V
E3	GND	E4	GND
1	+5V	2	PRESENT#
3	+5V	4	PCIE_WAKE#
5	+5V	6	MXM_PWRGD
7	+5V	8	NC
9	+5V	10	NC
11	GND	12	GND
13	GND	14	NC
15	GND	16	NC
17	GND	18	MXM_PWR_LEVEL
19	NC	20	MXM_TH_OVERT#
21	NC	22	MXM_TH_ALERT#
23	NC	24	NC
25	NC	26	NC
27	NC	28	NC
29	NC	30	NC
31	NC	32	SMB_DAT
33	NC	34	SMB_CLK
35	NC	36	GND
37	GND	38	NC
39	NC	40	NC
41	NC	42	NC

43			
	NC	44	NC
45	NC	46	GND
47	GND	48	PCIE_TX0-
49	PCIE_RX0-	50	PCIE_TX0+
51	PCIE_RX0+	52	GND
53	GND	54	PCIE_TX1-
55	PCIE_RX1-	56	PCIE_TX1+
57	PCIE_RX1+	58	GND
59	GND	60	PCIE_TX2-
61	PCIE_RX2-	62	PCIE_TX2+
63	PCIE_RX2+	64	GND
65	GND	66	PCIE_TX3-
67	PCIE_RX3-	68	PCIE_TX3+
69	PCIE_RX3+	70	GND
71	GND	72	PCIE_TX4-
73	PCIE_RX4-	74	PCIE_TX4+
75	PCIE_RX4+	76	GND
77	GND	78	PCIE_TX5-
79	PCIE_RX5-	80	PCIE_TX5+
81	PCIE_RX5+	82	GND
83	GND	84	PCIE_TX6-
85	PCIE_RX6-	86	PCIE_TX6+
87	PCIE_RX6+	88	GND
89	GND	90	PCIE_TX7-
91	PCIE_RX7-	92	PCIE_TX7+
93	PCIE_RX7+	94	GND
95	GND	96	PCIE_TX8-
97	PCIE_RX8-	98	PCIE_TX8+
99	PCIE_RX8+	100	GND
101	GND	102	PCIE_TX9-
103	PCIE_RX9-	104	PCIE_TX9+
105	PCIE_RX9+	106	GND
107	GND	108	PCIE_TX10-
109	PCIE_RX10-	110	PCIE_TX10+
111	PCIE_RX10+	112	GND
113	GND	114	PCIE_TX11-
115	PCIE_RX11-	116	PCIE_TX11+
117	PCIE_RX11+	118	GND
119	GND	120	PCIE_TX12-
121	PCIE_RX12-	122	PCIE_TX12+
123	PCIE_RX12+	124	GND
125	GND		KEY
	KEY	134	GND
133	GND	136	PCIE_TX13-
135	PCIE_RX13-	138	PCIE_TX13+
137	PCIE_RX13+	140	GND
139	GND	142	PCIE_TX14-

141	PCIE_RX14-	144	PCIE_TX14+
143	PCIE_RX14+	146	GND
145	GND	148	PCIE_TX15-
147	PCIE_RX15-	150	PCIE_TX15+
149	PCIE_RX15+	152	GND
151	GND	154	MXM_CLKREQ#
153	PCIE_CLK-	156	MXM_RST#
155	PCIE_CLK+	158	NC
157	GND	160	NC
159	NC	162	NC
161	NC	164	NC
163	NC	166	GND
165	NC	168	NC
167	NC	170	NC
169	NC	172	NC
171	NC	174	GND
173	GND	176	NC
175	NC	178	NC
177	NC	180	GND
179	GND	182	NC
181	NC	184	NC
183	NC	186	GND
185	GND	188	NC
187	NC	190	NC
189	NC	192	GND
191	GND	194	NC
193	NC	196	NC
195	NC	198	GND
197	GND	200	NC
199	NC	202	NC
201	NC	204	GND
203	GND	206	NC
205	NC	208	NC
207	NC	210	GND
209	GND	212	NC
211	NC	214	NC
213	NC	216	GND
215	GND	218	NC
217	NC	220	NC
219	NC	222	GND
221	GND	224	NC
223	NC	226	NC
225	NC	228	GND
227	NC	230	NC
229	NC	232	NC
231	NC	234	NC
233	NC	236	NC
235	NC	238	NC

237	NC	240	+3.3V
239	NC	242	+3.3V
241	NC	244	GND
243	NC	246	NC
245	NC	248	NC
247	NC	250	GND
249	NC	252	NC
251	GND	254	NC
253	NC	256	GND
255	NC	258	NC
257	GND	260	NC
259	NC	262	GND
261	NC	264	NC
263	GND	266	NC
265	NC	268	GND
267	NC	270	NC
269	GND	272	NC
271	NC	274	NC
273	NC	276	NC
275	GND	278	+3.3V
277	NC	280	+3.3V
279	NC		
281	MXM_PRSENT#		

2.17 COM Port Pin Header #1/#2 (COM12)

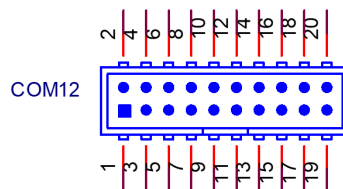

Pin	Signal	Pin	Signal
1	COM1_DCD#	2	COM1_DSR#
3	COM1_SIN	4	COM1_RTS#
5	COM1_SOUT	6	COM1_CTS#
7	COM1_DDTR#	8	COM1_RI#
9	GND	10	GND
11	COM2_DCD#	2	COM2_DSR#
13	COM2_SIN	4	COM2_RTS#
15	COM2_SOUT	6	COM2_CTS#
17	COM2_DDTR#	8	COM2_RI#
19	GND	20	GND

2.18 DDR5 SODIMM Socket A1 / B1 (DIMMA1/B1)

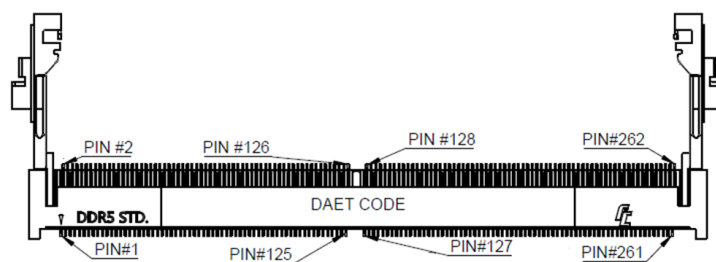

Please see JEDEC STANDARD

2.19 CPU FAN Connector (CPUFAN1)

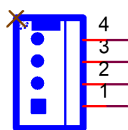

Pin	Signal
1	GND
2	VCC
3	FAN SPEED
4	PWM

2.20 System Fan #1 Connector / System Fan #2 Connector (SYSFAN1/2)

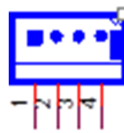
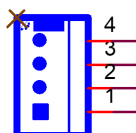

Pin	Signal
1	GND
2	VCC
3	FAN SPEED
4	PWM

2.21 SIM Card Socket (SIM1)

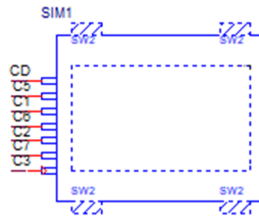

Pin	Signal
C1	UIM_PWR
C2	UIM_RESET
C3	UIM_CLK
C5	GND
C6	UIM_VPP
C7	UIM_DATA
C8	SIM_DET

2.22 LED Port 80 Connector (LED_P80)

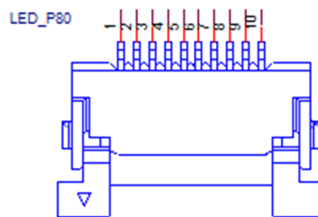

Pin	Signal
1	GND
2	LED_A
3	LED_B
4	LED_C
5	LED_D
6	LED_E
7	LED_F
8	LED_G
9	DGH0#
10	DGL0#

2.23 Voltage Selection for EDP1 Connector (JEDP1)

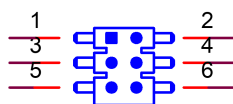

Pin	Signal	Pin	Signal
1	NC	2	+V5
3	+V12	4	+VDD_EDP
5	NC	6	+V3.3

2.24 CMOS Battery Connector (BAT1)

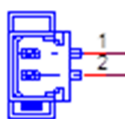

Pin	Signal
1	+VBAT
2	GND

2.25 RTC Reset Pin Header (JCMOS1)

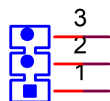

Pin	Signal
1	N.C.
2	RTC RESET#
3	GND

2.26 PWRBTN# / RESET# / HDD LED / SM bus (JFP1)

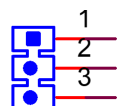

Pin	Signal	Pin	Signal
1	HDD_LED+	2	PWRBTN#
3	HDD_LED-	4	GND
5	SMB_DAT	6	SYS_RESET#
7	SMB_CLK	8	GND

2.27 Power LED Pin Header (JFP2)

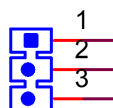

Pin	Signal
1	PWR_LED+
2	N.C.
3	PWR_LED-

2.28 AT/ATX Mode Selection (PSON1)

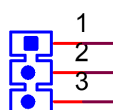

Pin	Signal
1	VCCAT
2	+3.3V
3	VCCATX

Chapter 3

BIOS Operation

3.1 Introduction

With the AMI BIOS setup program, you can modify BIOS settings and control the special features of your computer. The setup program uses a number of menus for making changes and turning special features on or off. This chapter describes the basic navigation of the AIMB-286 setup screens.

3.2 BIOS Setup

The AIMB-288E Series system has AMI BIOS built in, with a CMOS SETUP utility that allows users to configure required settings or to activate certain system features. The CMOS SETUP saves the configuration in the CMOS RAM of the motherboard. When the power is turned off, the battery on the board supplies the necessary power to preserve the CMOS RAM.

When the power is turned on, press the button during the BIOS POST (Power-On Self Test) to access the CMOS SETUP screen.

Control Keys	
< ↑ >< ↓ >< ← >< → >	Move to select item
<Enter>	Select item
<Esc>	Main Menu - Quit without saving changes to the CMOS Sub-Menu - Exit the current page and return to the Main Menu
<Page Up/+>	Increase the numeric value or make changes
<Page Down/->	Decrease the numeric value or make changes
<F1>	General help, for Setup sub-menu
<F2>	Loads previous values
<F3>	Loads optimized defaults
<F4>	Save and Exit

3.2.1 Main Menu

Press to enter the AMI BIOS CMOS Setup Utility. The Main Menu will appear on the screen. Use the arrow keys to select among the items and press <Enter> to accept or enter the sub-menu.

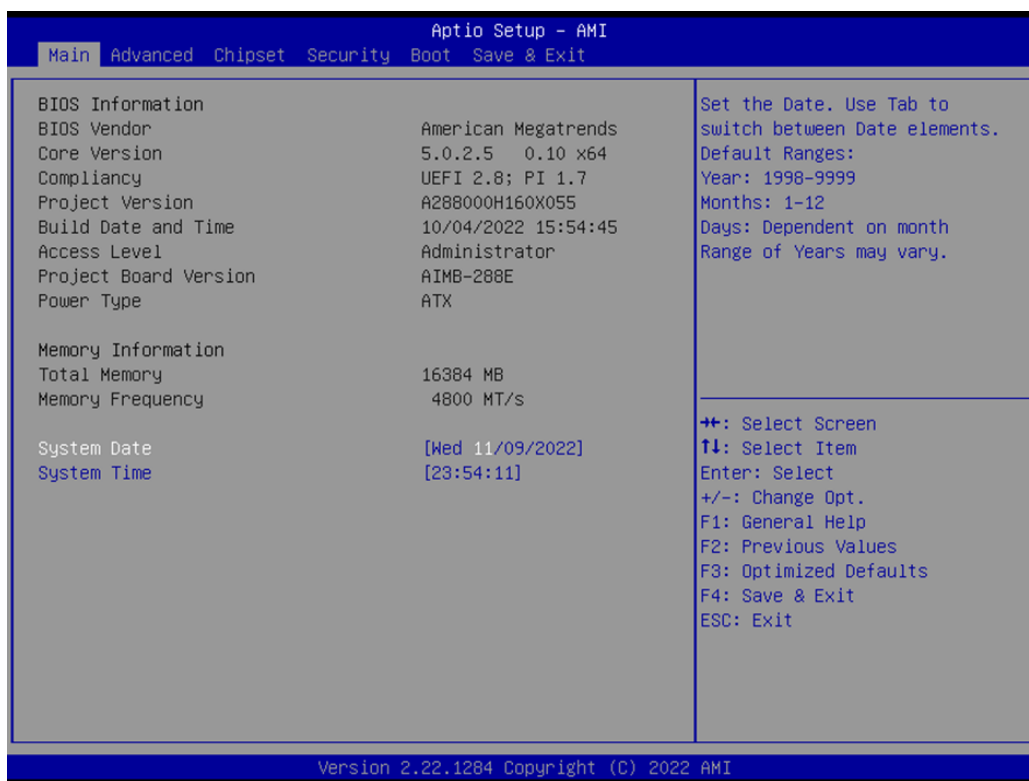

The Main BIOS setup screen has two main frames. The left frame displays all the options that can be configured. Grayed-out options cannot be configured; options in blue can. The right frame displays the legend.

Above the legend is an area reserved for a text message. When an option is selected in the left frame, it is highlighted in white. Often a text message will accompany it.

■ System Time / System Date

Use this option to change the system time and date. Highlight the System Time or System Date using the <Arrow> keys. Enter new values via the keyboard.

Press the <Tab> or <Arrow> keys to move between fields. The date must be entered in MM/DD/YY format. The time must be entered in HH:MM:SS format.

3.2.2 Advanced BIOS Features

Select the Advanced tab from the AIMB-288E setup menu to enter the Advanced BIOS setup page. Users can select any item in the left frame of the screen, such as CPU configuration. Select an Advanced BIOS setup option by highlighting the text using the <Arrow> keys. All Advanced BIOS setup options are described in this section. The Advanced BIOS setup menu screen is shown below. The sub-menus are described in the following pages.

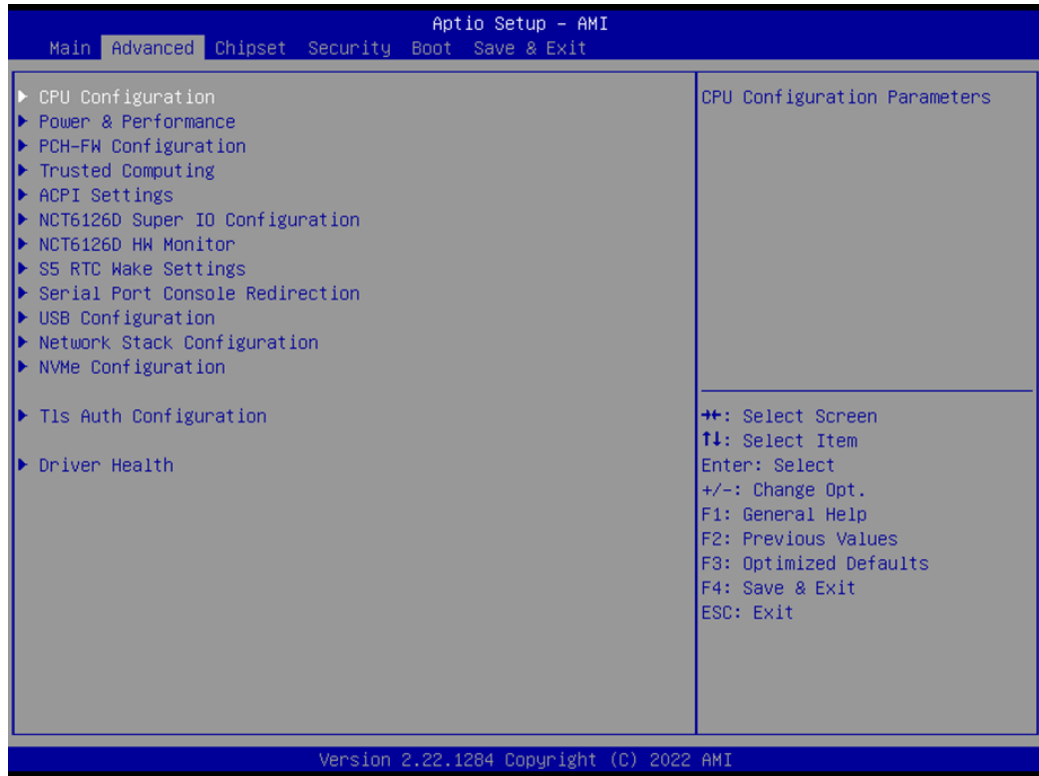

3.2.2.1 CPU Configuration

Advanced → CPU Configuration

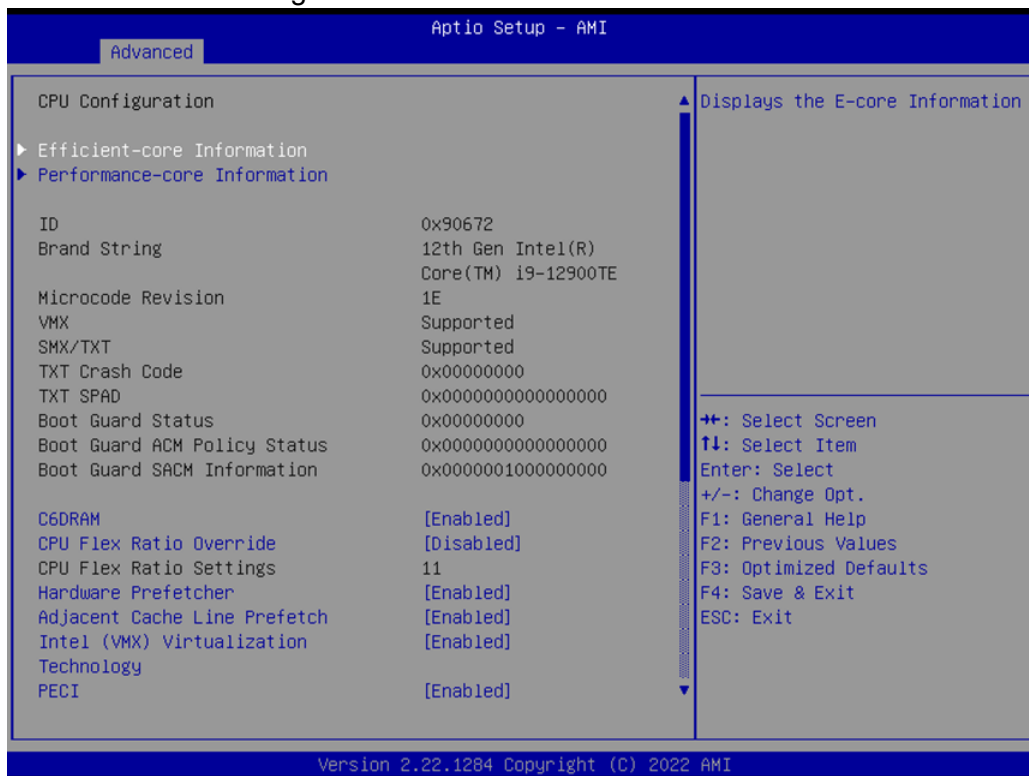

Efficient-core Information

Advanced → CPU Configuration → Efficient-core Information



Performance-core Information

Advanced → CPU Configuration → Performance-core Information

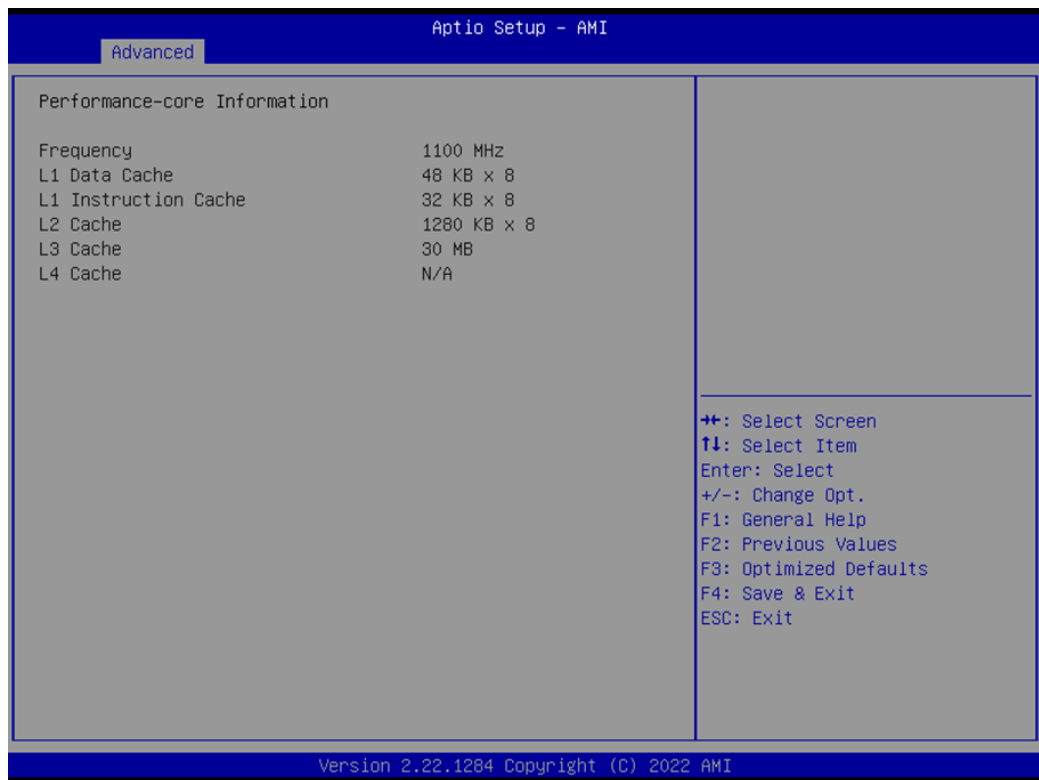

CPU SMM Enhancement

Advanced → CPU SMM Enhancement



3.2.2.2 Power & Performance

Advanced → Power & Performance



CPU – Power Management Control

Advanced → Power & Performance → CPU – Power Management Control

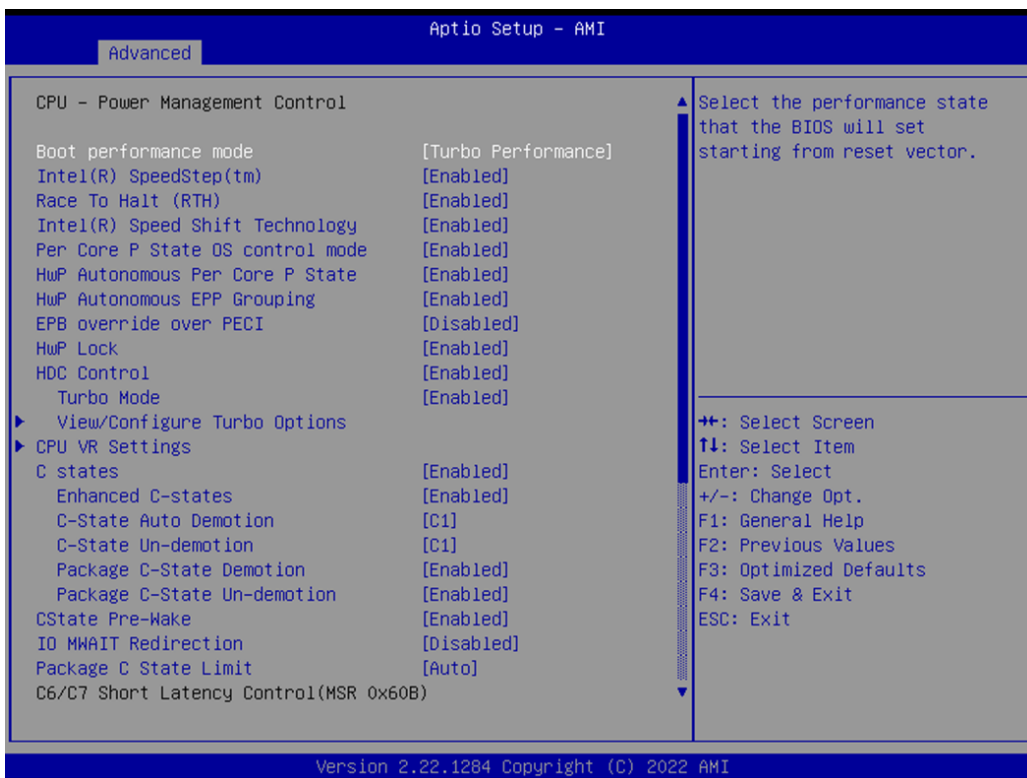

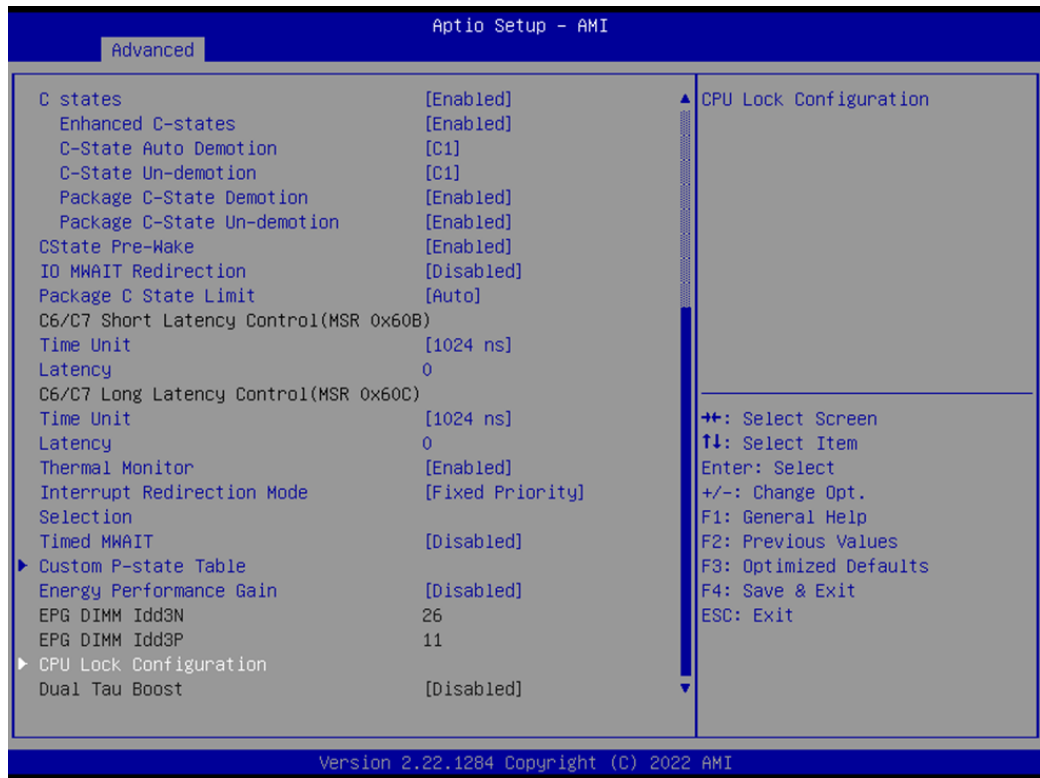

Current Turbo Settings

Advanced → Power & Performance → CPU – Power Management Control → View/Configure Turbo Ratio

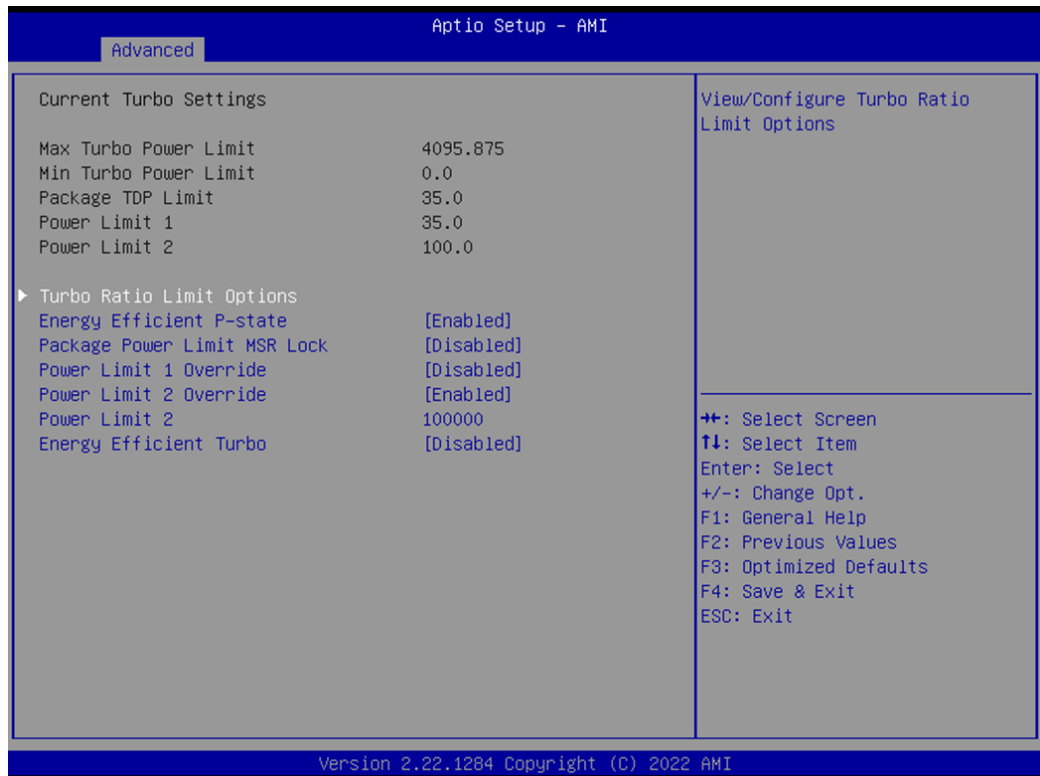

Turbo Ratio Limit Options

Advanced → Power & Performance → CPU – Power Management Control → View/
Configure Turbo Ratio → Turbo Ratio Limit Options

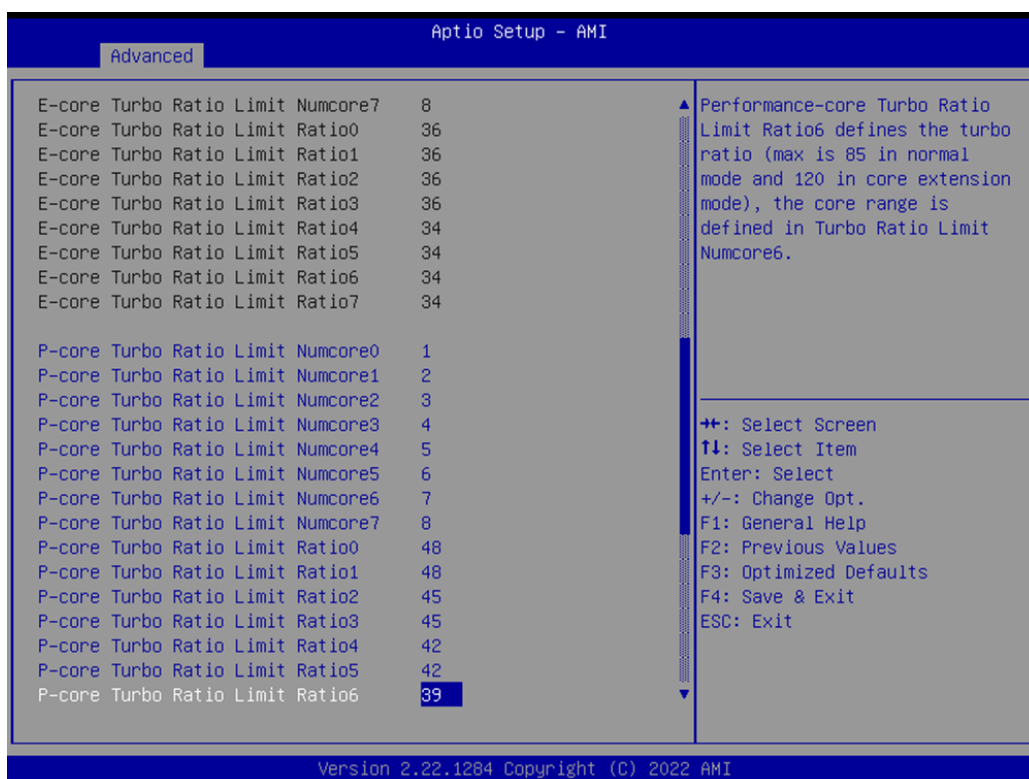
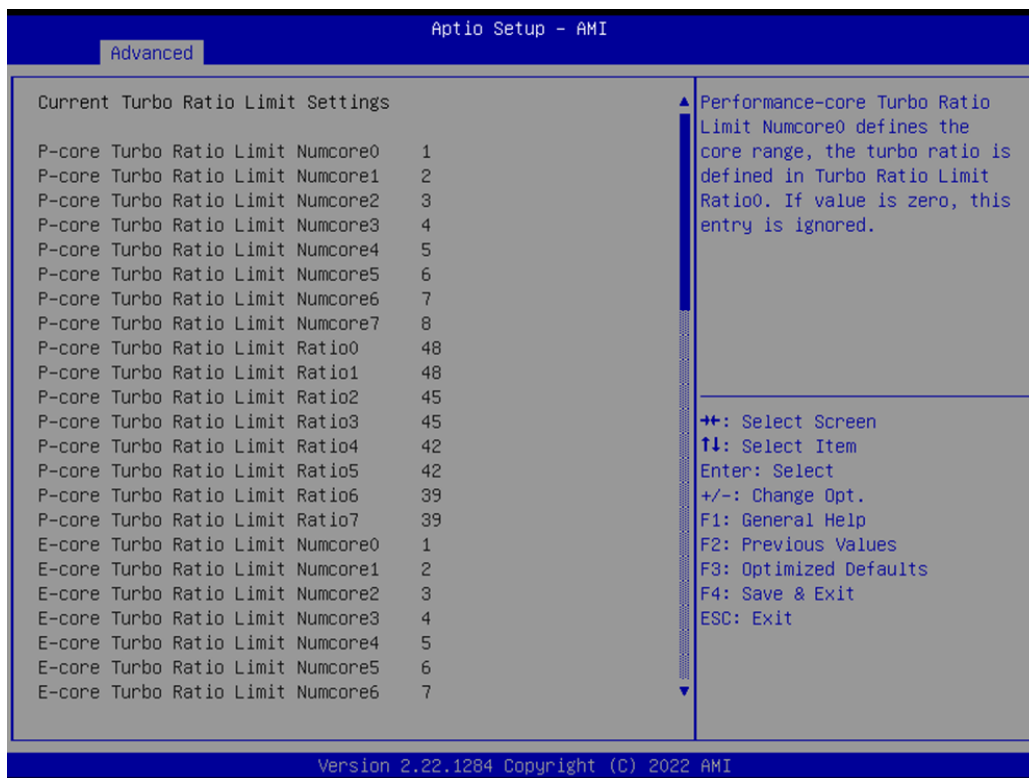



CPU VR Settings

Advanced → Power & Performance → CPU – Power Management Control → CPU VR Settings

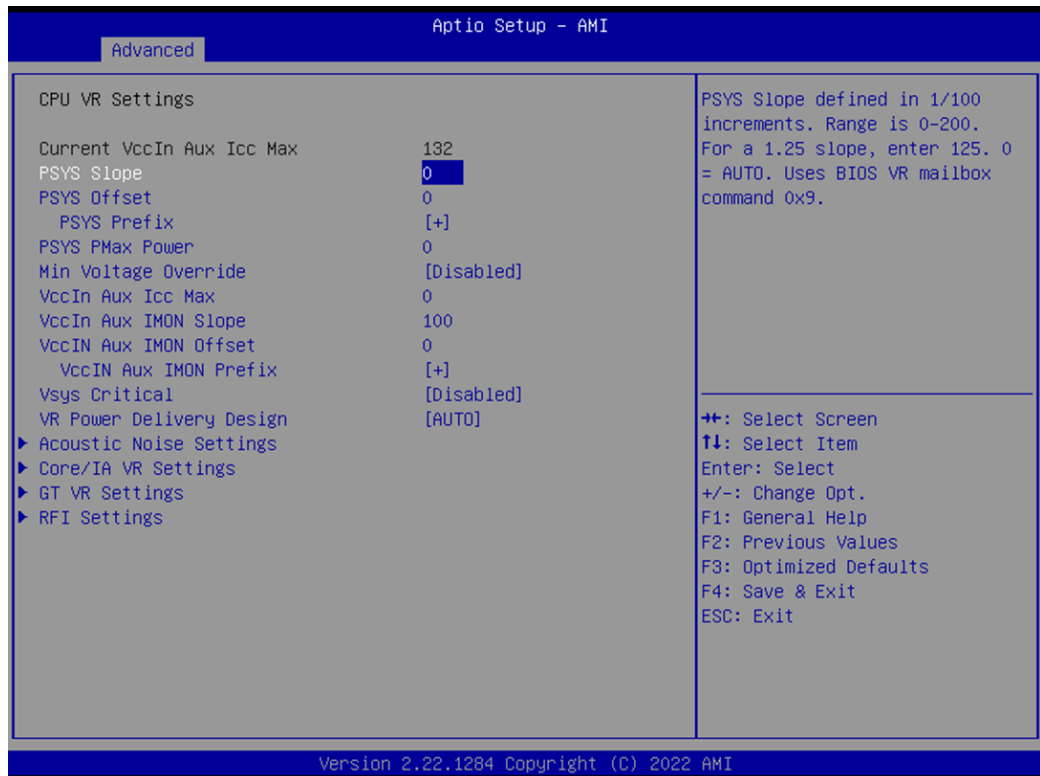

Acoustic Noise Settings

Advanced → Power & Performance → CPU – Power Management Control → CPU VR Settings → Acoustic Noise Settings



Core/IA VR Settings

Advanced → Power & Performance → CPU – Power Management Control → CPU VR Settings → Core/IA Settings

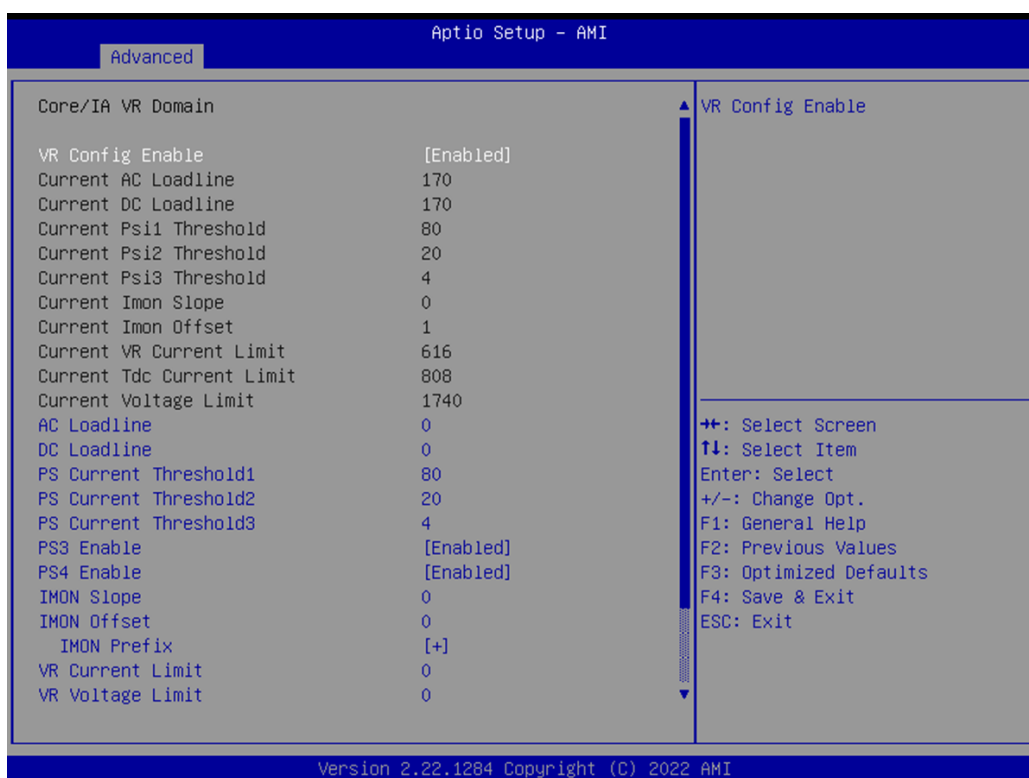



GT VR Settings

Advanced → Power & Performance → CPU – Power Management Control → CPU VR Settings → GT VR Settings

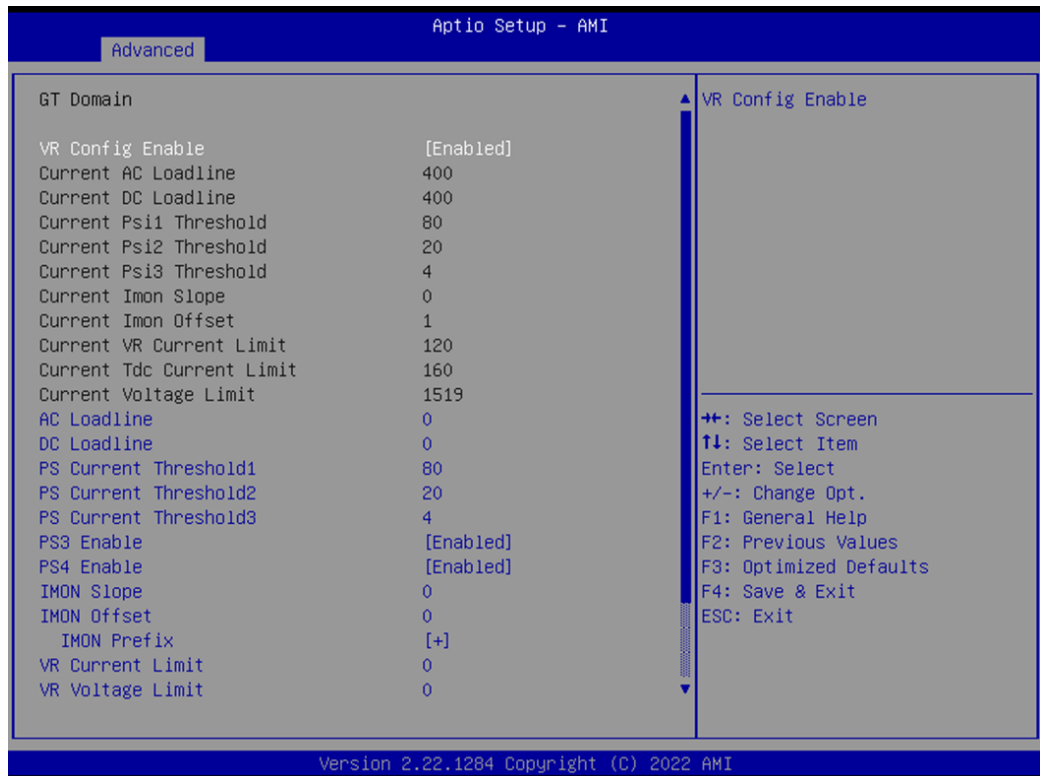

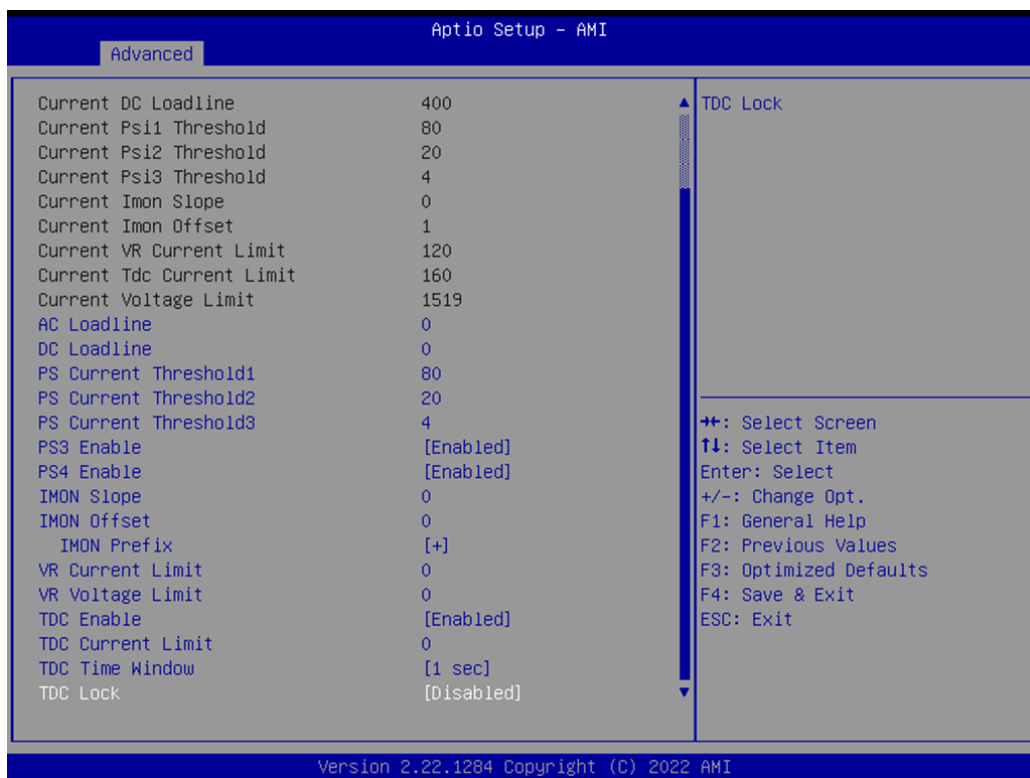

RFI Settings

Advanced → Power & Performance → CPU – Power Management Control → CPU VR Settings → RFI Settings



Custom P-state Table

Advanced → Power & Performance → CPU – Power Management Control → Custom P-state Table

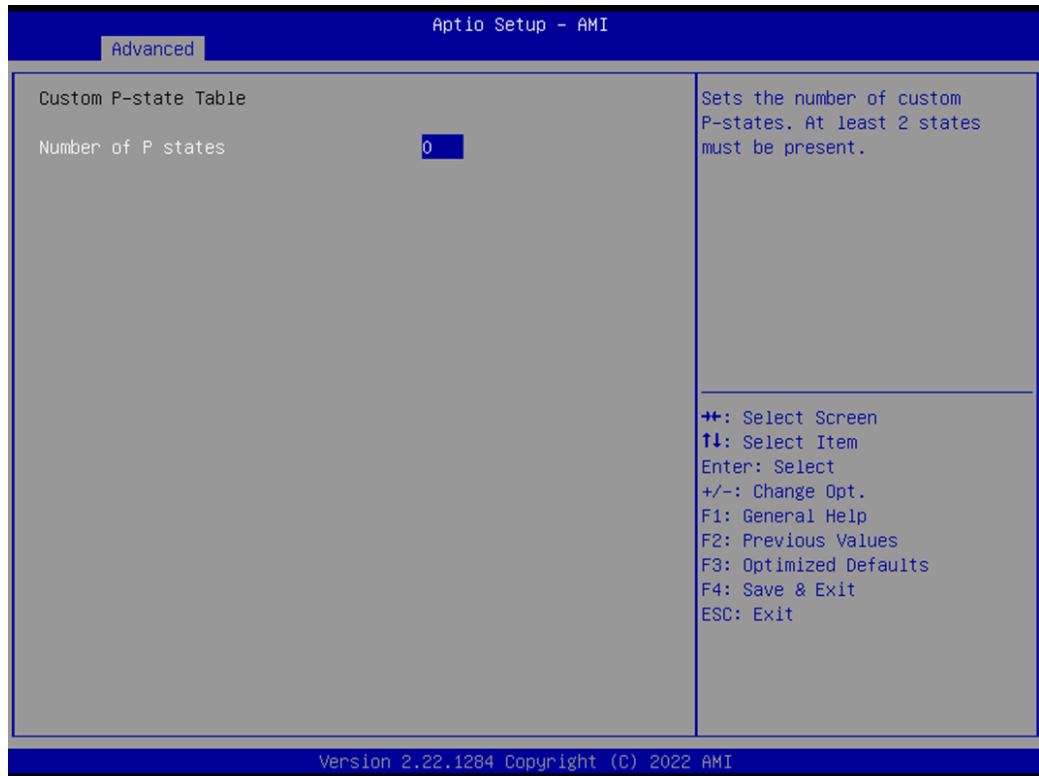

CPU Lock Configuration

Advanced → Power & Performance → CPU – Power Management Control → CPU Lock Configuration



GT – Power Management Control

Advanced → Power & Performance → GT – Power Management Control

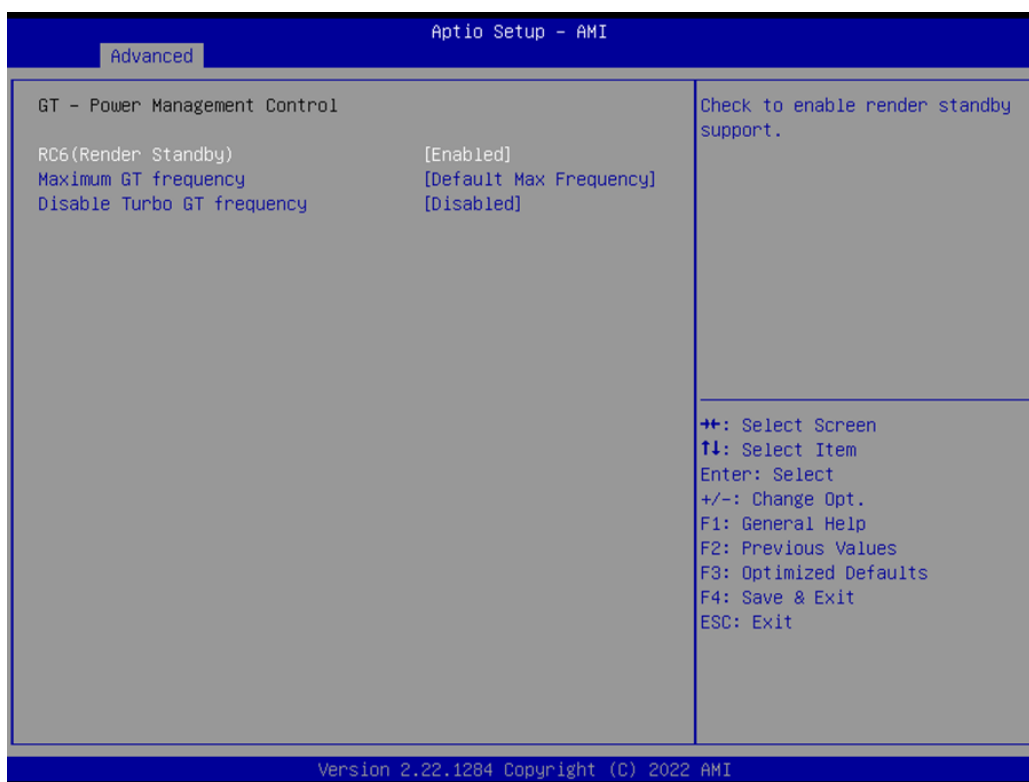

3.2.2.3 PCH-FW Configuration

Advanced → PCH-FW Configuration

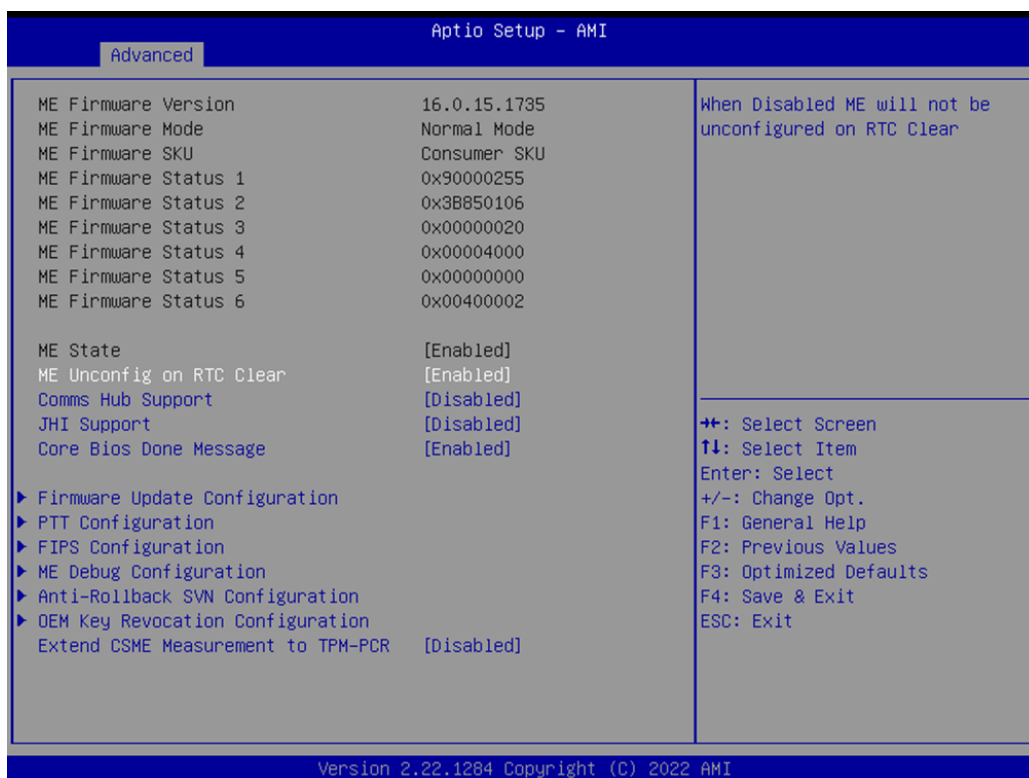

Firmware Update Configuration

Advanced → PCH-FW Configuration → Firmware Update Configuration

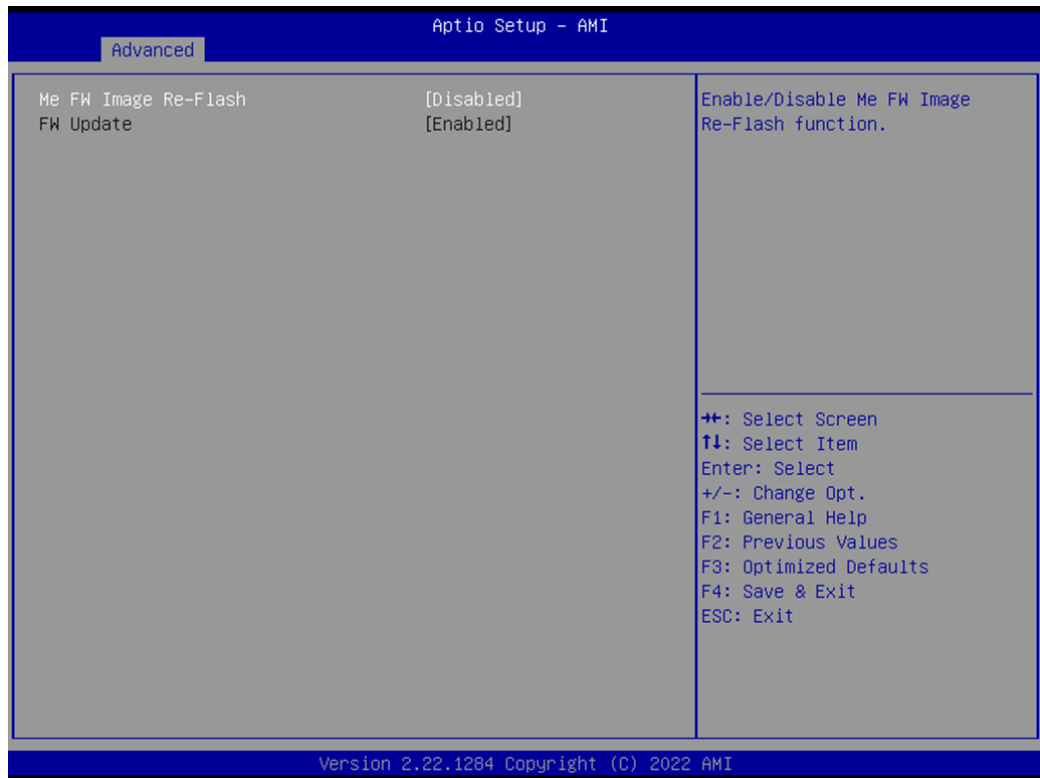

PTT Configuration

Advanced → PCH-FW Configuration → PTT Configuration

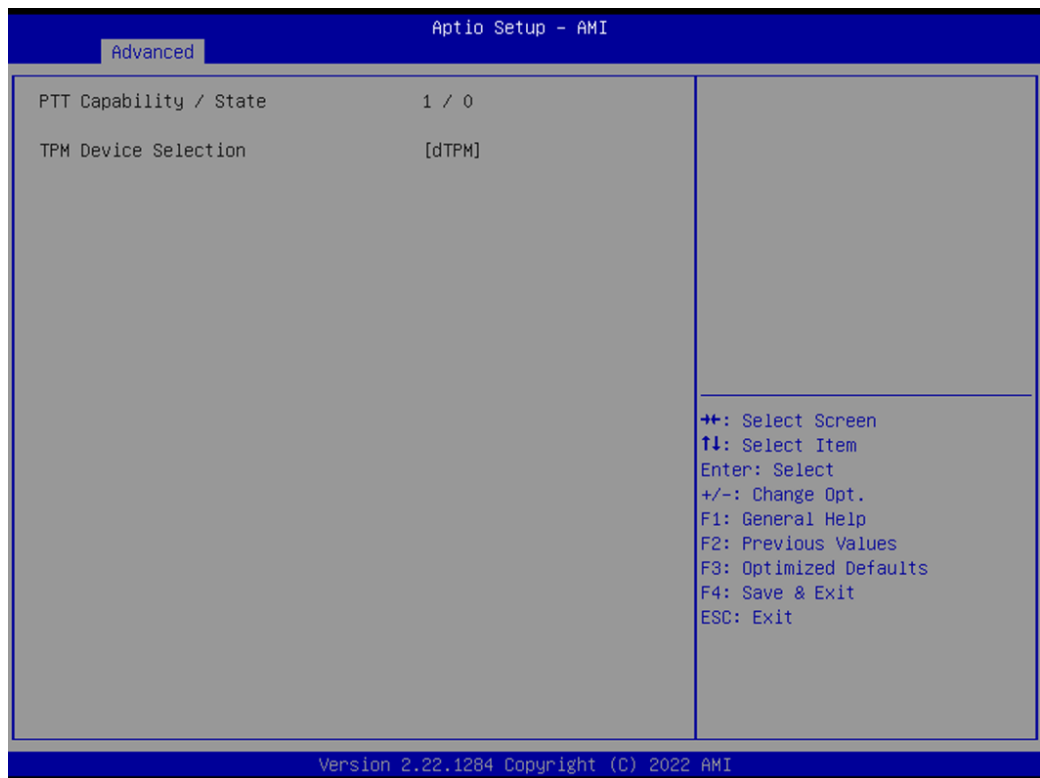

FIPS Configuration

Advanced → PCH-FW Configuration → FIPS Configuration

**ME debug Configuration**

Advanced → PCH-FW Configuration → ME debug Configuration

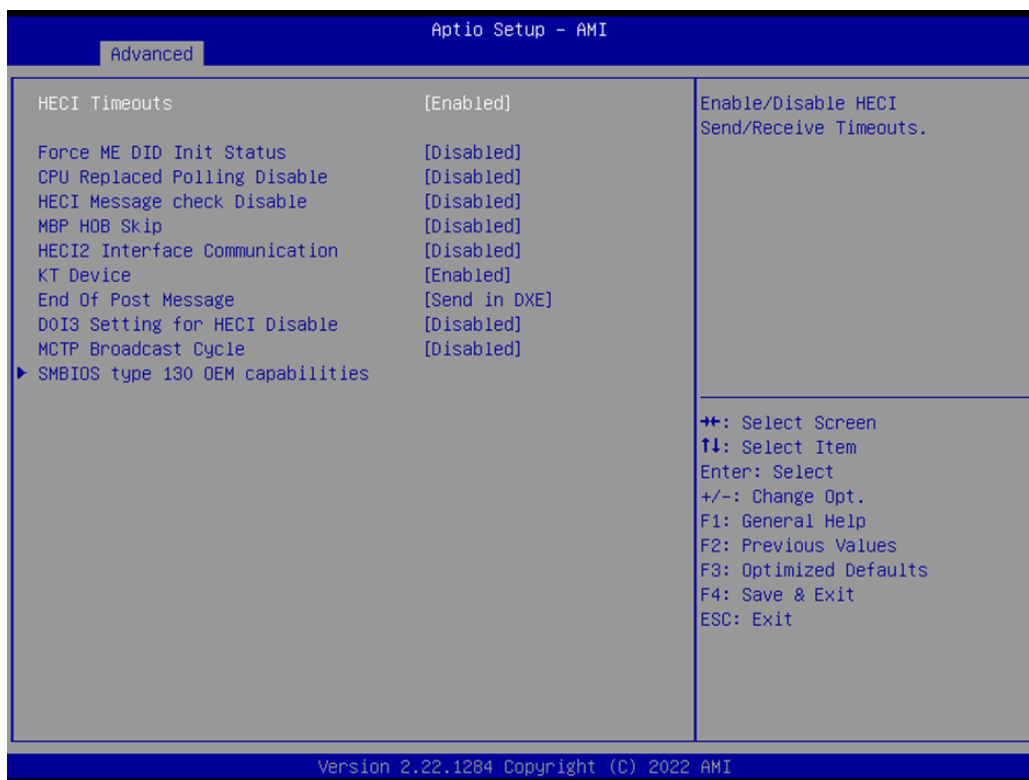

SMBIOS Type 130 OEM Capabilities

Advanced → PCH-FW Configuration → ME Debug Configuration → SMBIOS Type 130 OEM Capabilities



Anti-Rollback SVN Configuration

Advanced → PCH-FW Configuration → Anti-Rollback SVN Configuration



OEM Key Revocation Configuration

Advanced → PCH-FW Configuration → OEM Key Revocation Configuration

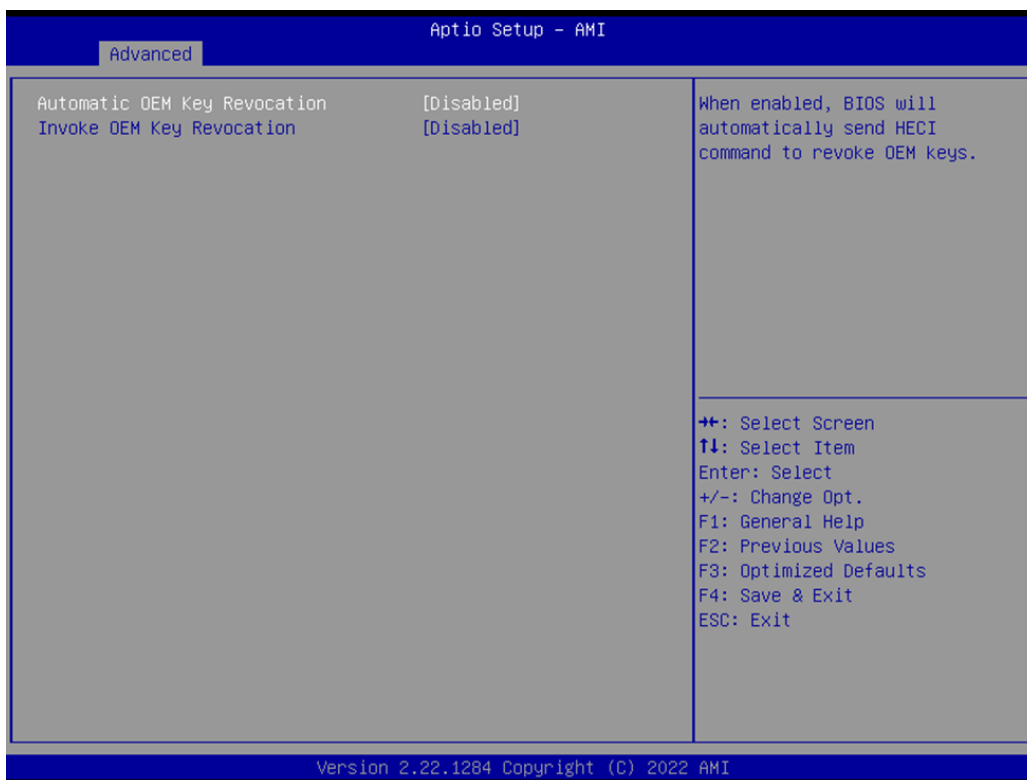

3.2.2.4 Trusted Computing Settings

Advanced → Trusted Computing

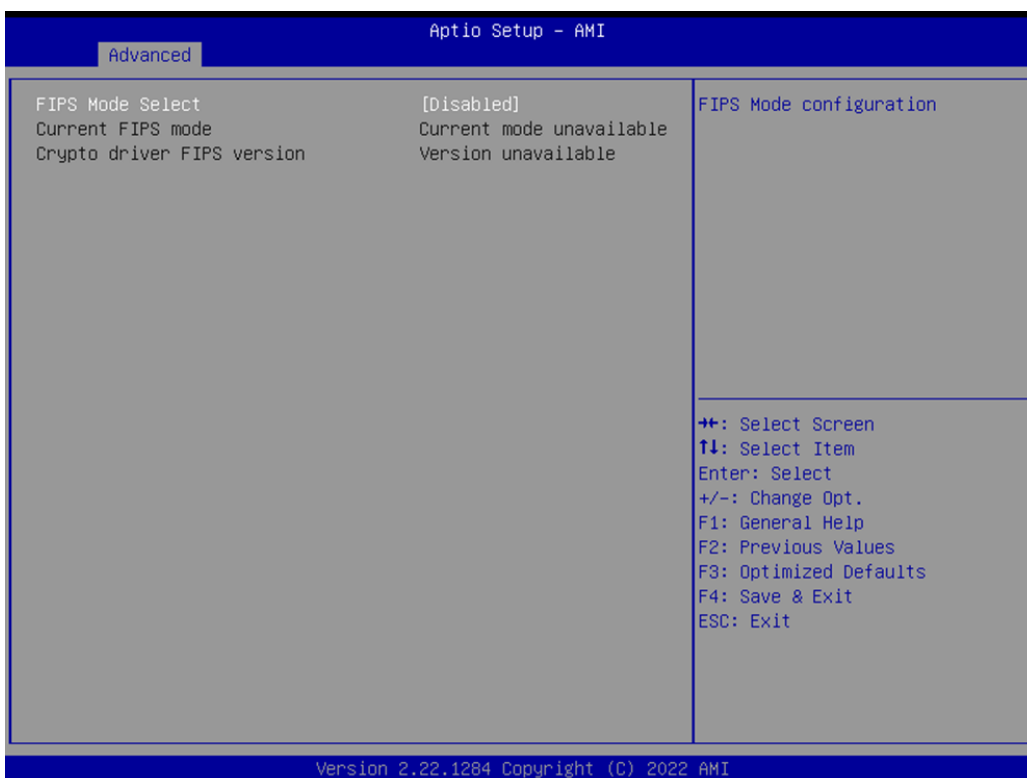

3.2.2.5 ACPI Settings

Advanced → ACPI Settings

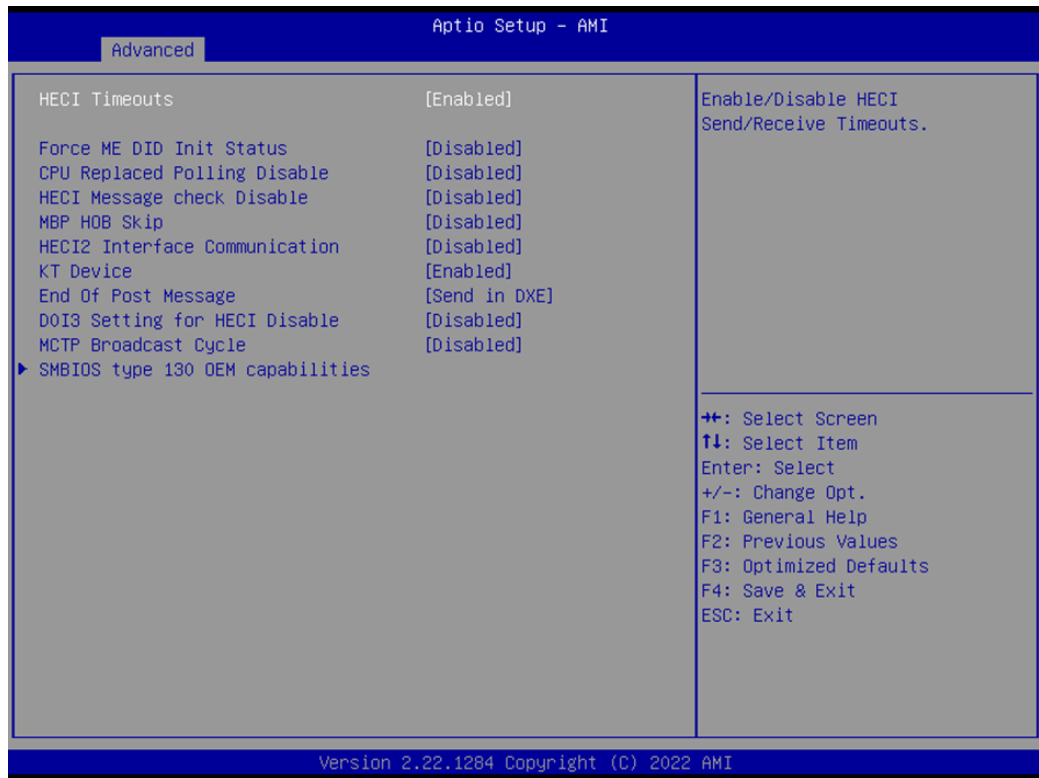

3.2.2.6 NCT6126D Super IO configuration

Advanced → NCT6126D Super IO Configuration

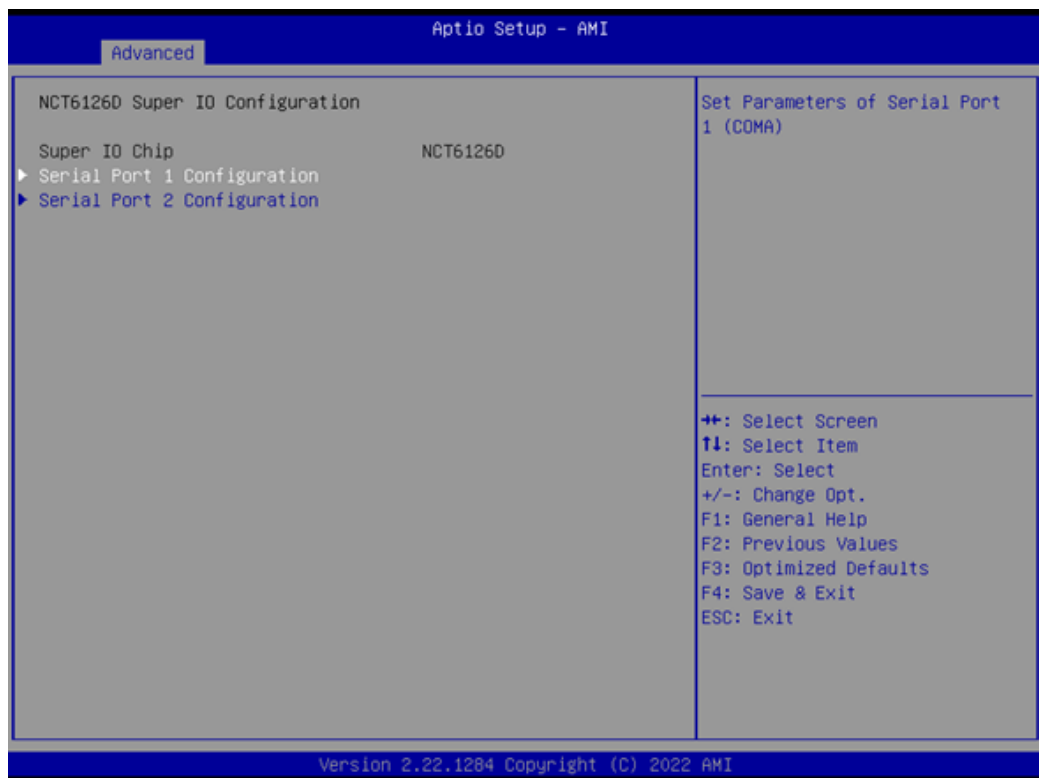

Serial Port 1 Configuration

Advanced → NCT6126D Super IO Configuration → Serial Port 1 Configuration

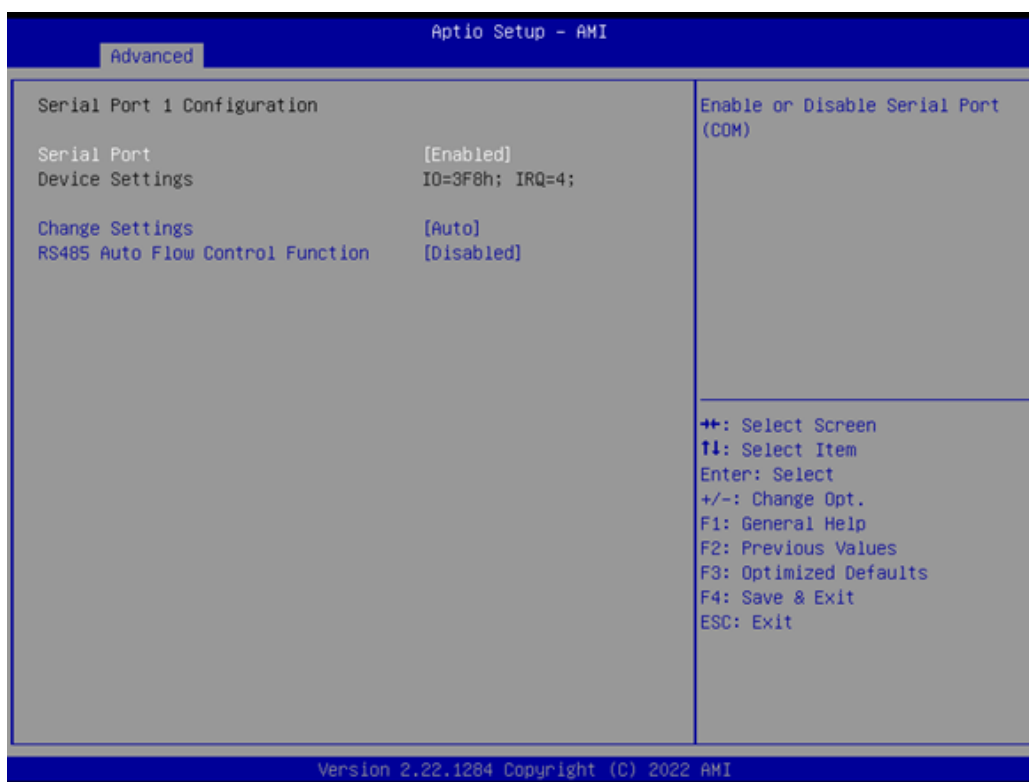

Serial Port 2 Configuration

Advanced → NCT6126D Super IO Configuration → Serial Port 2 Configuration

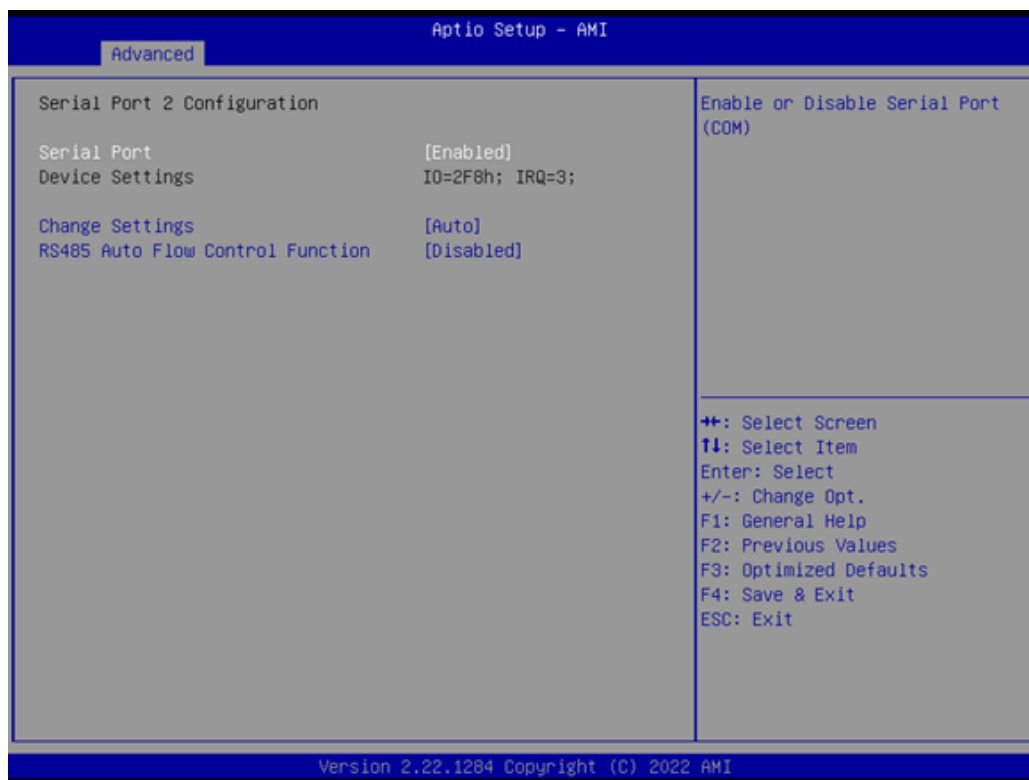

3.2.2.7 NCT6126D HW Monitor

Advanced → NCT6126D HW Monitor

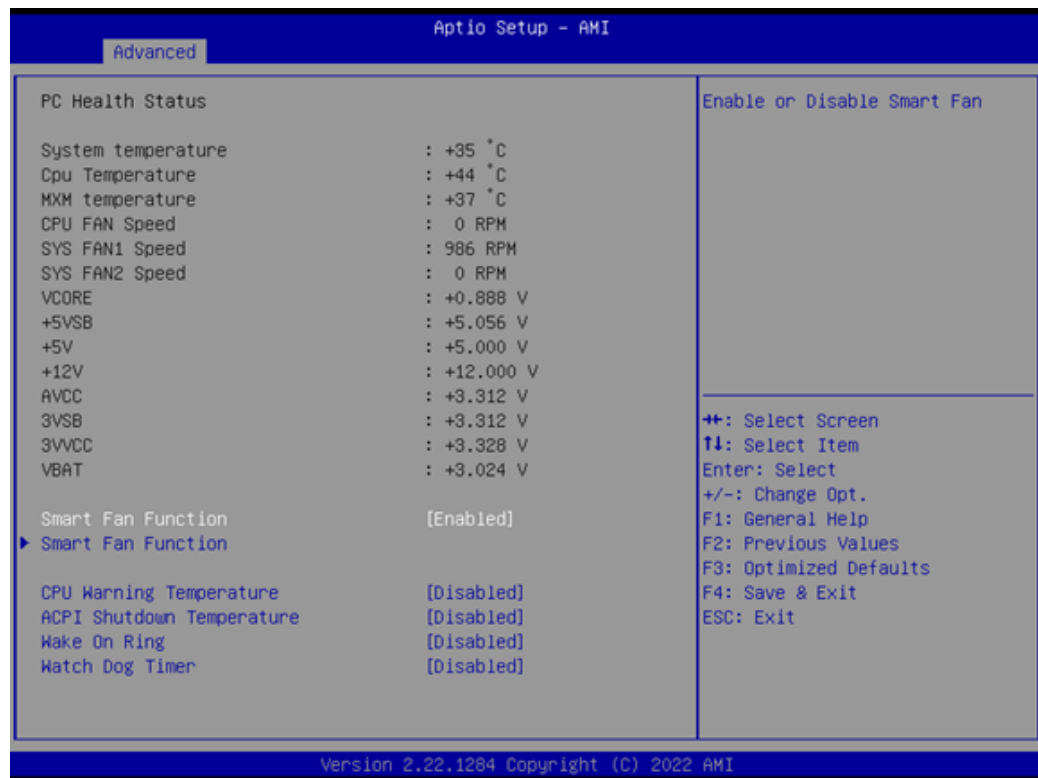

Smart Fan Function

Advanced → NCT6126D HW Monitor → Smart Fan Function

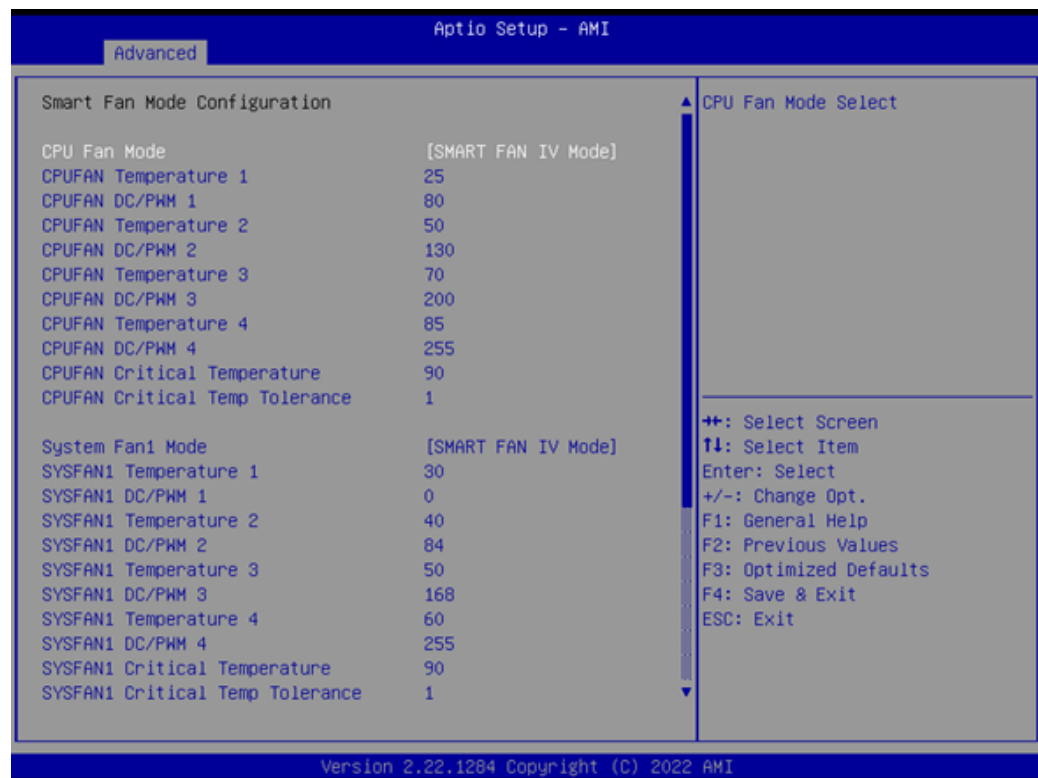

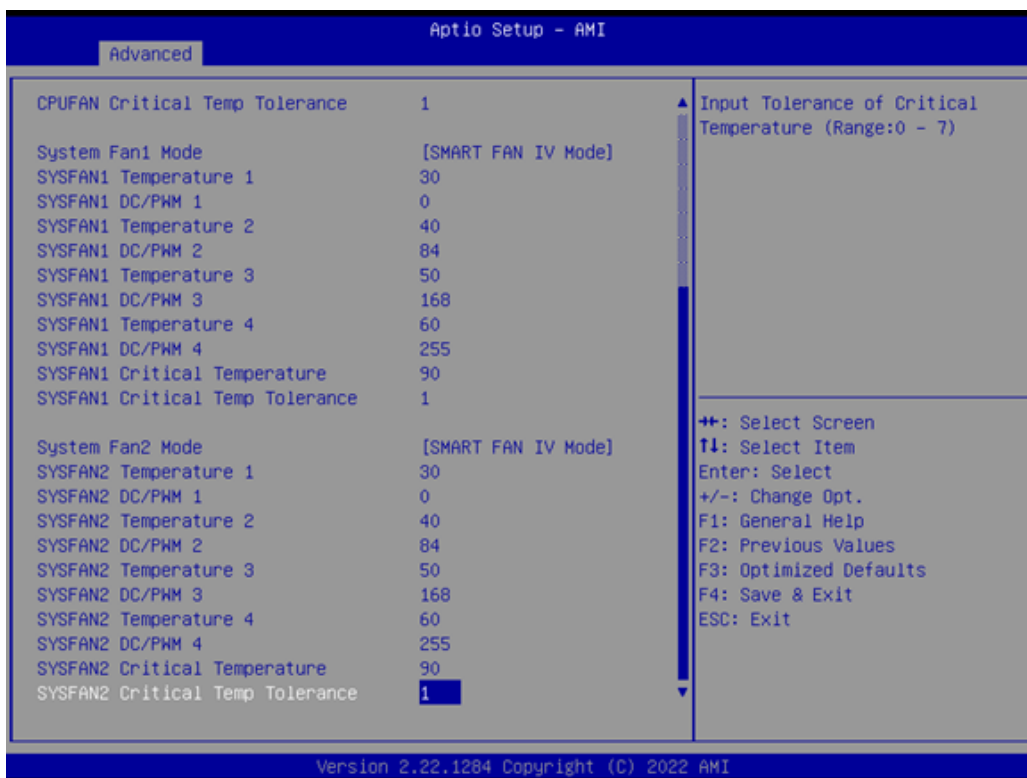

3.2.2.8 S5 RTC Wake Settings

Advanced → S5 RTC Wake Settings



3.2.2.9 Serial Port Console Redirection

Advanced → Serial Port Console Redirection



Legacy Console Redirection Settings

Advanced → Serial Port Console Redirection → Legacy Console Redirection Settings



3.2.2.10 USB Configuration

Advanced → USB Configuration

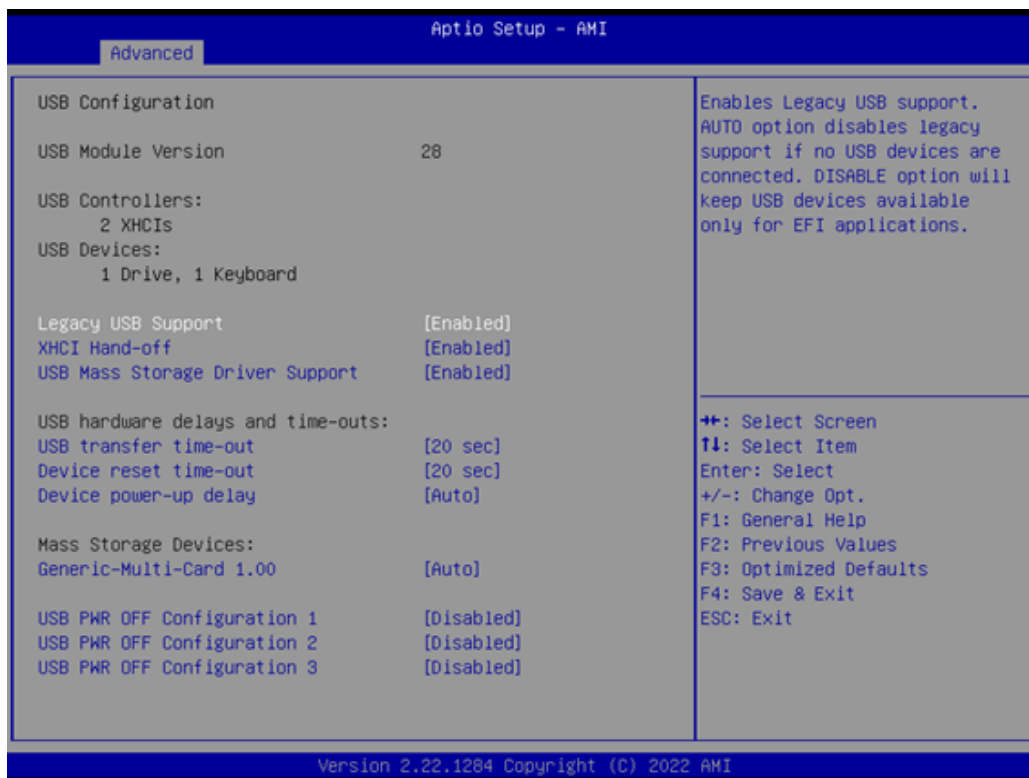

3.2.2.11 Network Stack Configuration

Advanced → Network Stack Configuration



3.2.2.12 NVMe Configuration

Advanced → NVMe Configuration



3.2.2.13 TLS Auth Configuration

Advanced → TLS Auth Configuration



3.2.2.14 Driver Health

Advanced → Driver Health



3.2.3 Chipset Configuration Setting

Select the chipset tab from the BIOS setup screen to enter the Chipset Setup screen. Users can select any item in the left frame of the screen, such as PCI Express Configuration, to go to the sub-menu for that item. Users can display a Chipset Setup option by highlighting it using the <Arrow> keys. All Chipset Setup options are described in this section. The Chipset Setup screens are shown below. The sub-menus are described on the following pages.



3.2.3.1 System Agent (SA) Configuration

Chipset → System Agent (SA) Configuration

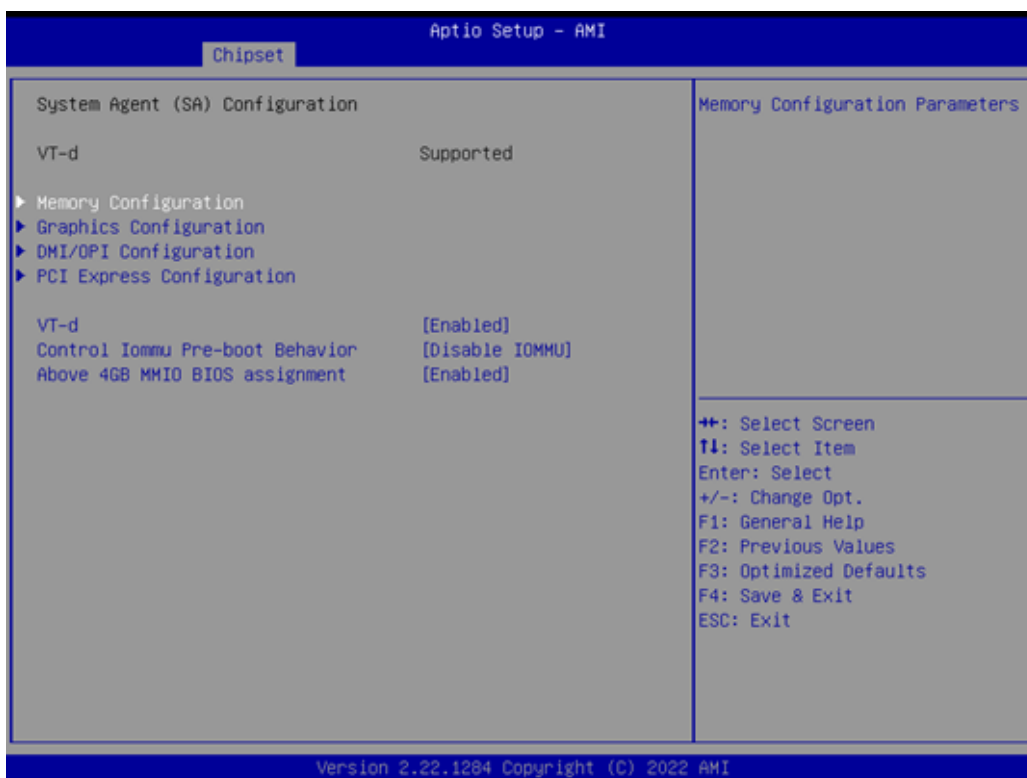

Memory Configuration

Chipset → System Agent (SA) Configuration → Memory Configuration

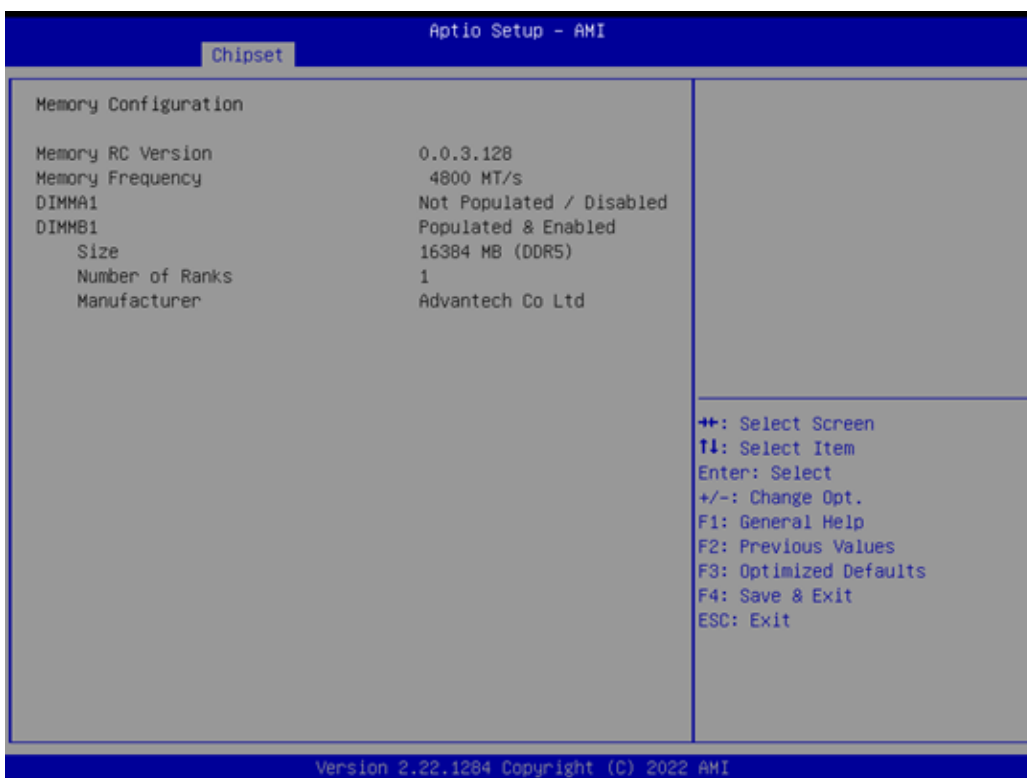

Graphics Configuration

Chipset → System Agent (SA) Configuration → Graphics Configuration

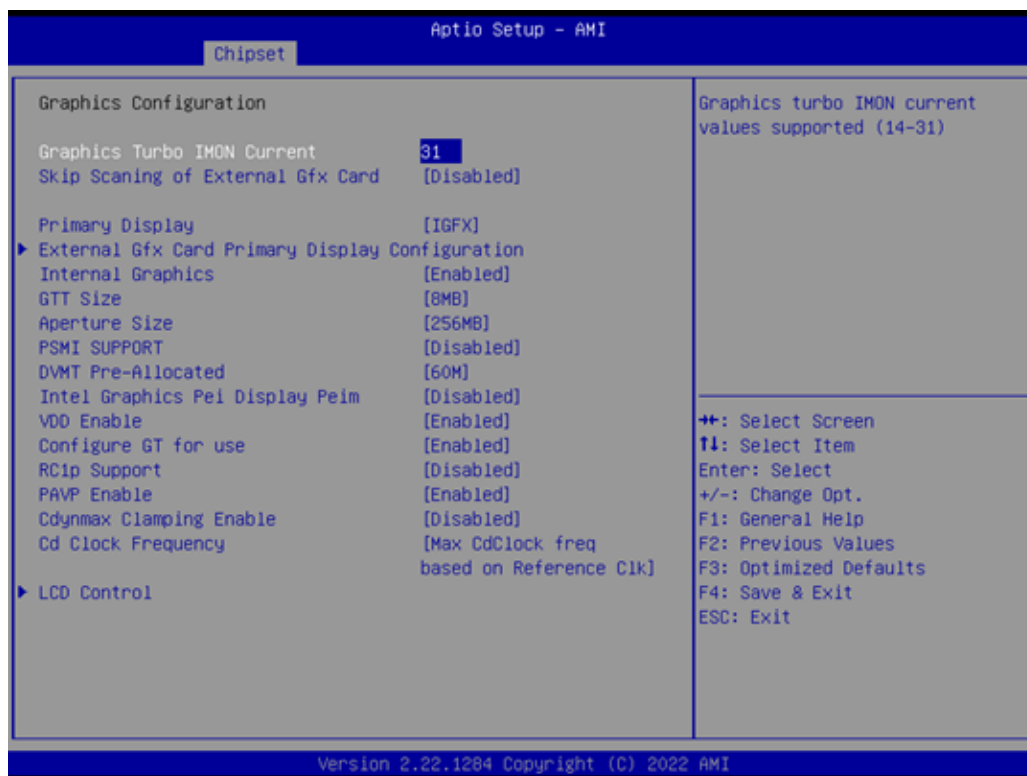

External Gfx Card Primary Display Configuration

Chipset → System Agent (SA) Configuration → Graphics Configuration → External Gfx Card Primary Display Configuration



LCD Control

Chipset → System Agent (SA) Configuration → Graphics Configuration → LCD Control



DMI/OPI Configuration

Chipset → System Agent (SA) Configuration → DMI/OPI Configuration



DMI Advanced Menu

Chipset → System Agent (SA) Configuration → DMI/OPI Configuration → DMI Advanced Menu

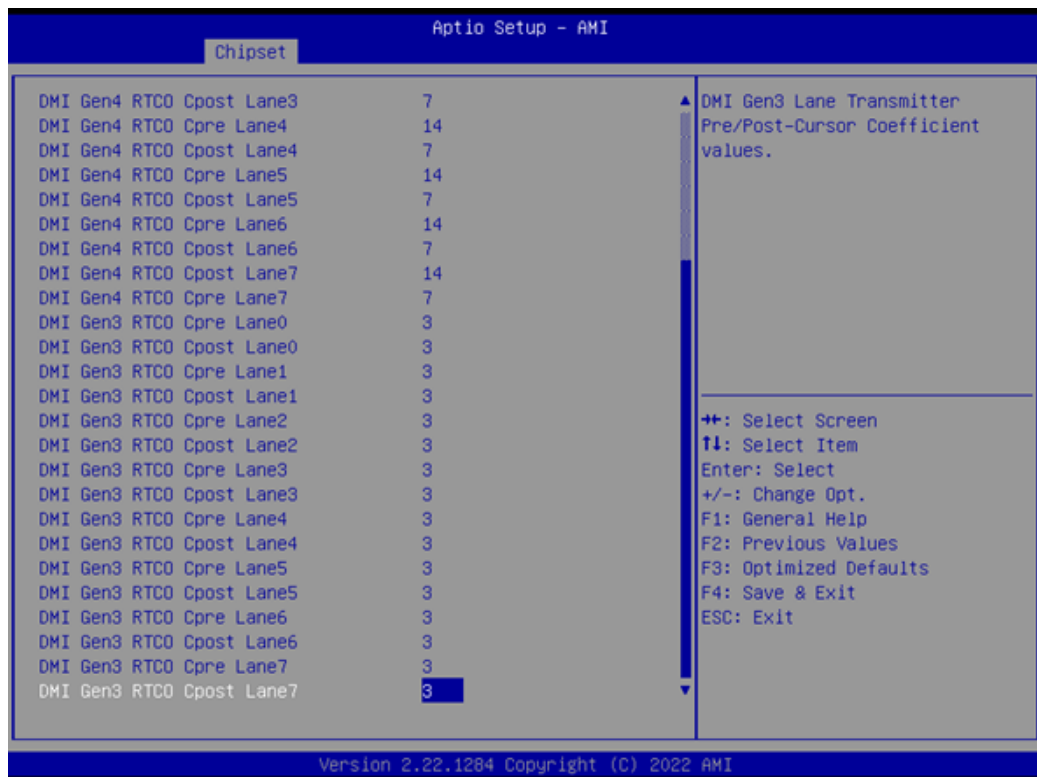
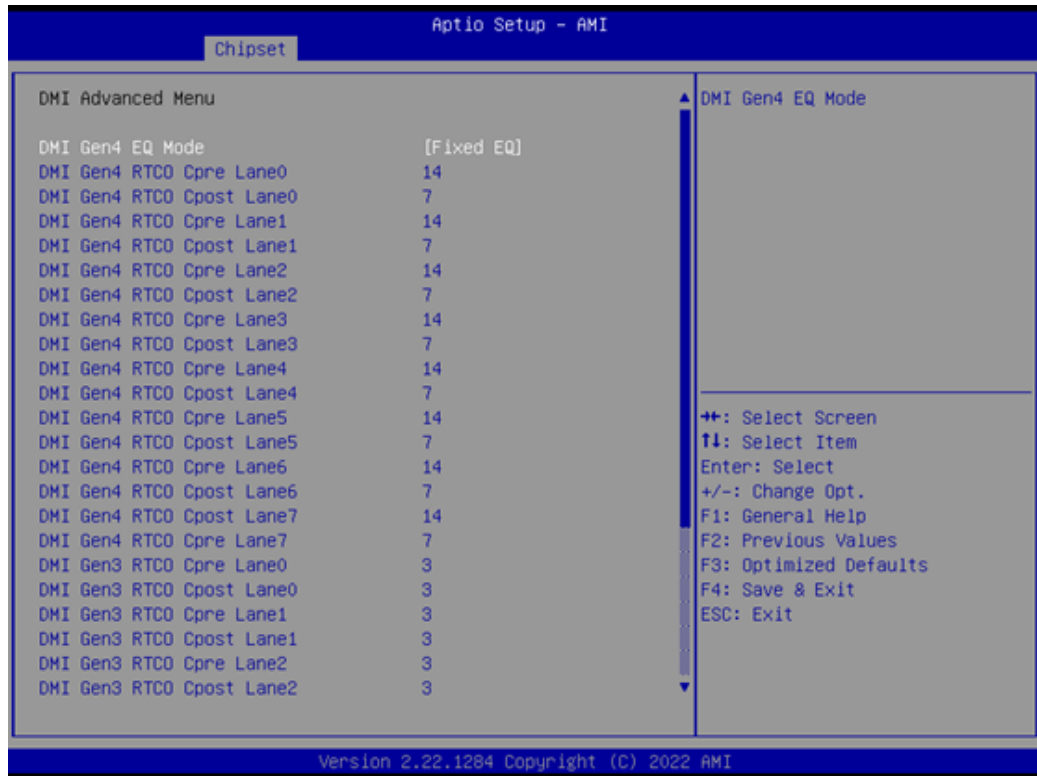

PCI Express Configuration

Chipset → System Agent (SA) Configuration → PCI Express Configuration



MXM 3.1 (3D) Controller

Chipset → System Agent (SA) Configuration → PCI Express Configuration → MXM 3.1 (3D) Controller

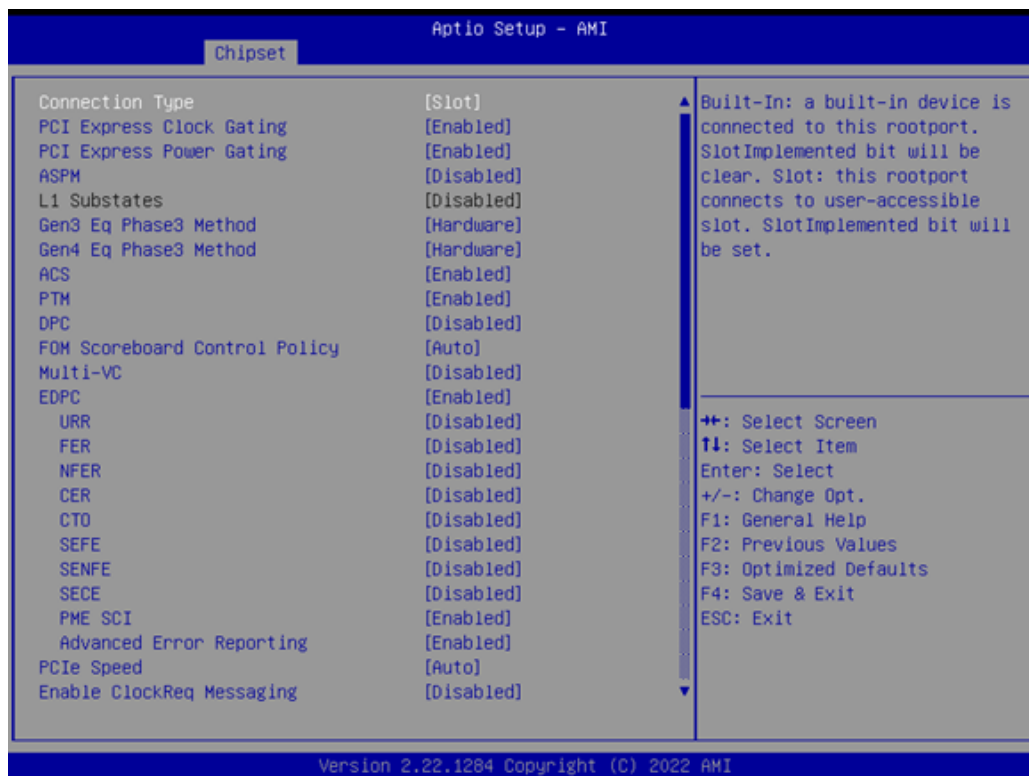

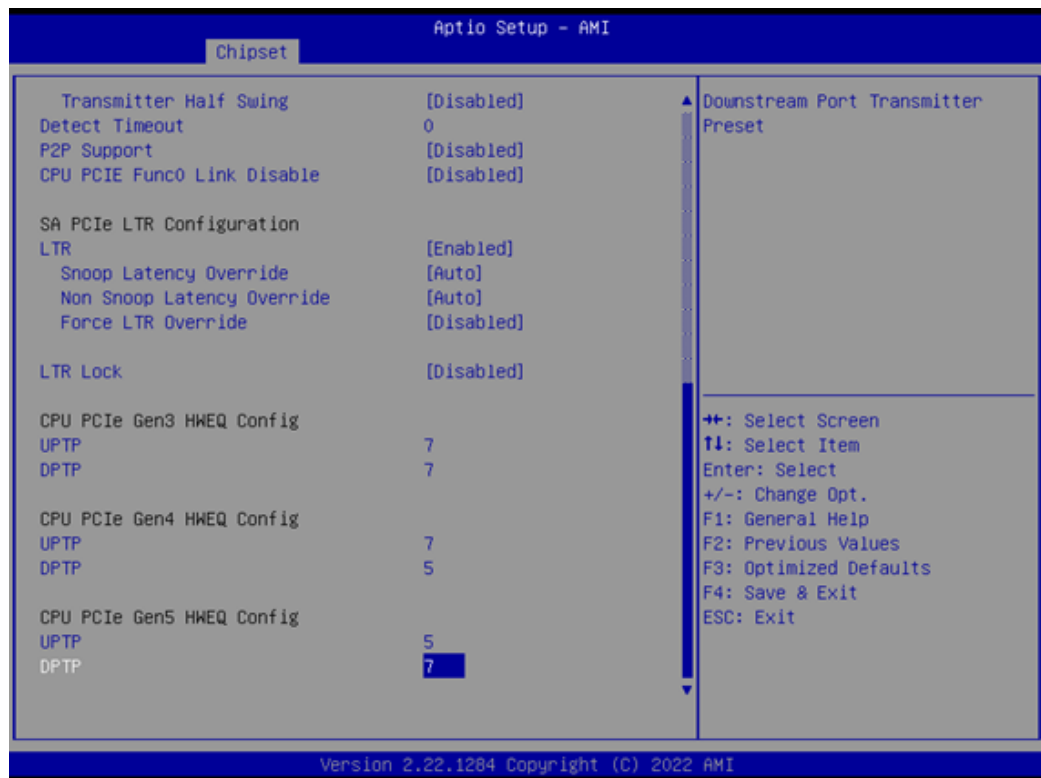

3.2.3.2 PCH-I/O Configuration

Chipset → PCH-IO Configuration



ErP Support Note

Chipset → PCH-IO Configuration → ErP Support



When ErP is enabled, restore AC power loss & the below features are not supported.

[USB: S3/S4]

[PCIe Wake] Connect to PCIe slots depending on add-on card driver behavior.

[RTC: S5]

[WOR: S5]

[WOL: depends on LAN chip and driver behavior (GBE)]

Supports S3/S4/S5 (with I219 & I226)

PCI Express Configuration

Chipset → PCH-IO Configuration → PCI Express Configuration

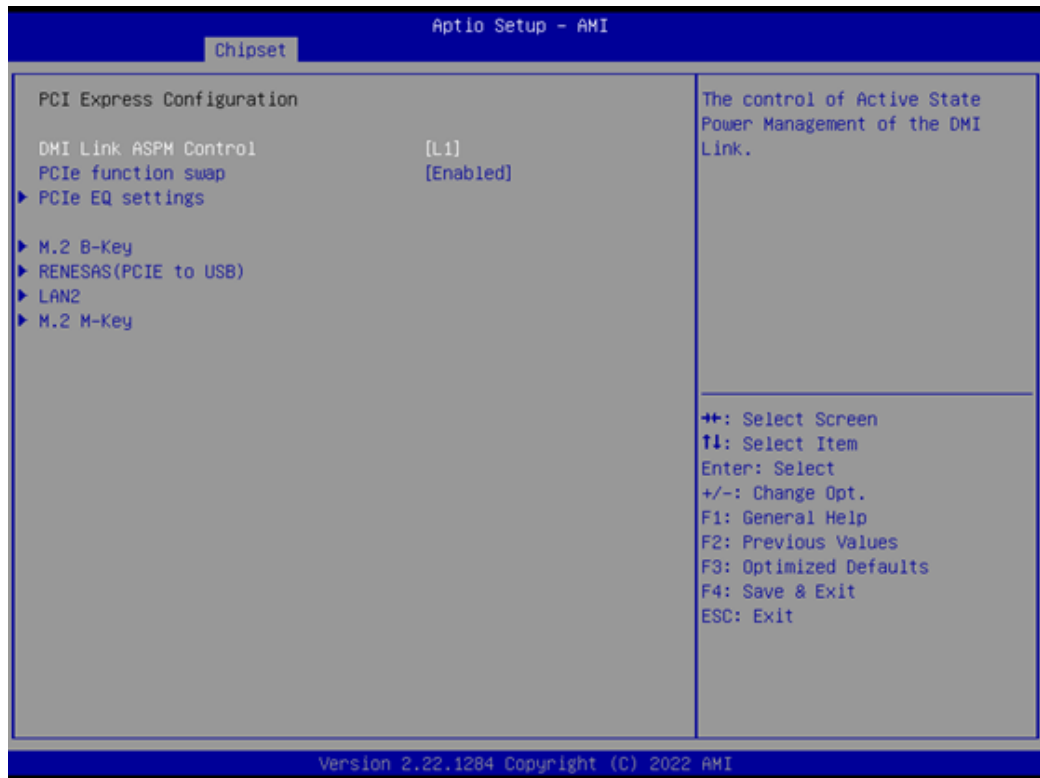

PCIe EQ Settings

Chipset → PCH-IO Configuration → PCI Express Configuration → PCIe EQ Settings



M.2 B-Key

Chipset → PCH-IO Configuration → PCI Express Configuration → M.2 B-Key

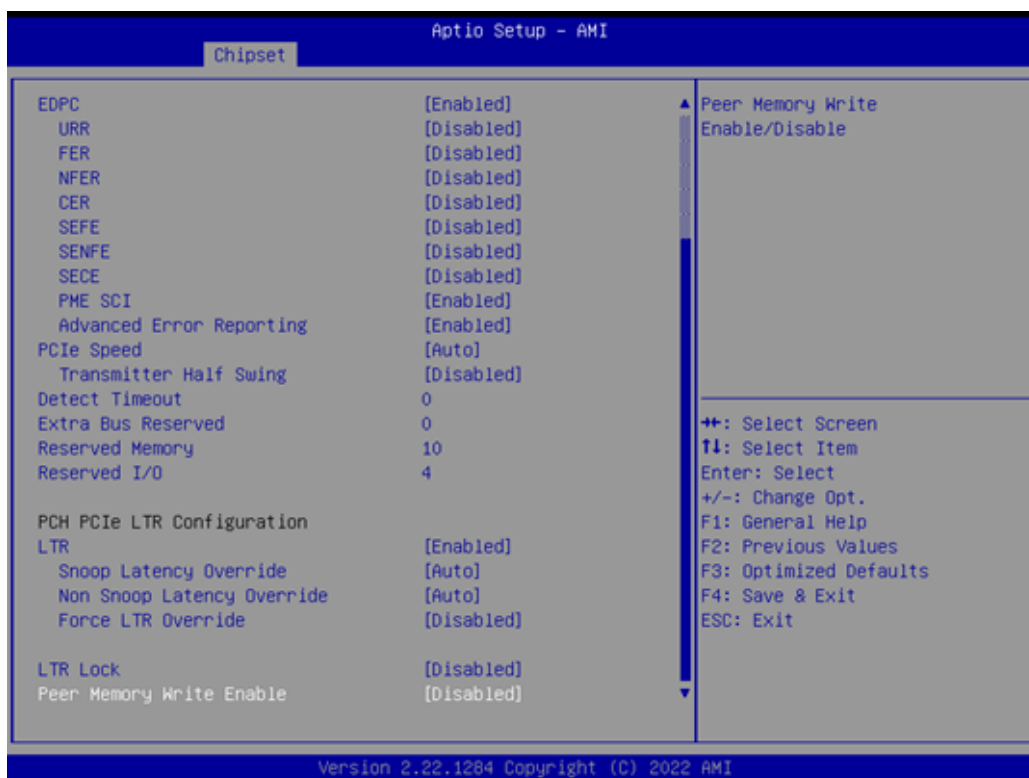
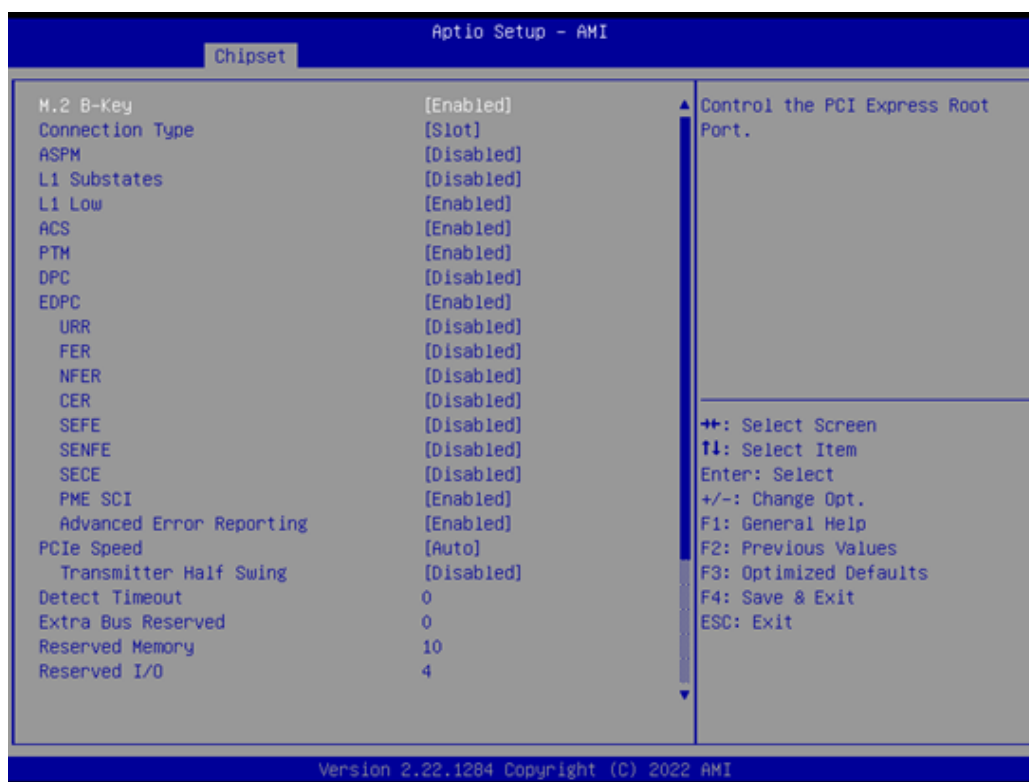

RENESAS (PCIE to USB)

Chipset → PCH-IO Configuration → PCI Express Configuration → RENESAS (PCIE to USB)

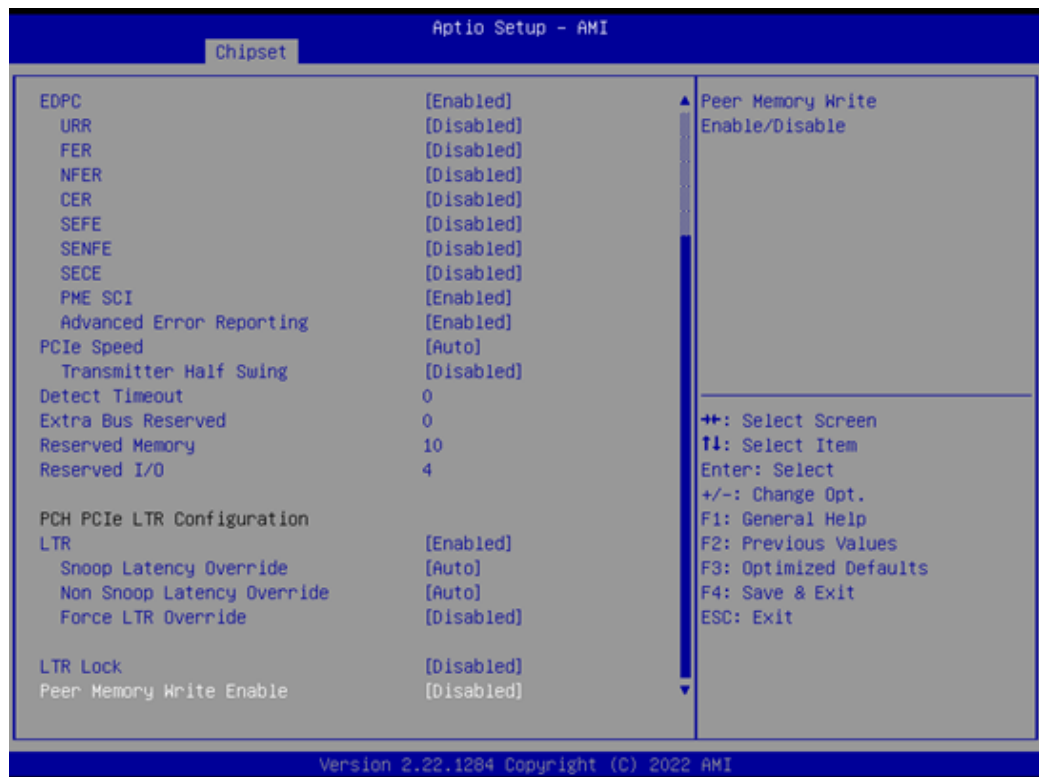
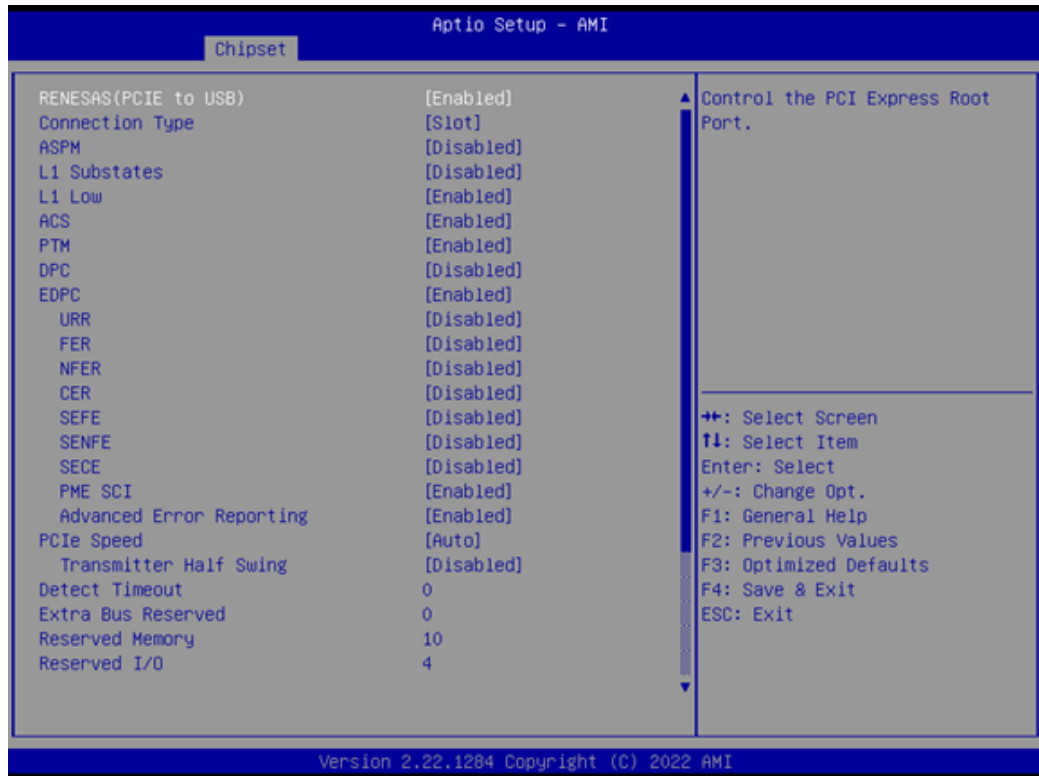

LAN2

Chipset → PCH-IO Configuration → PCI Express Configuration → LAN2

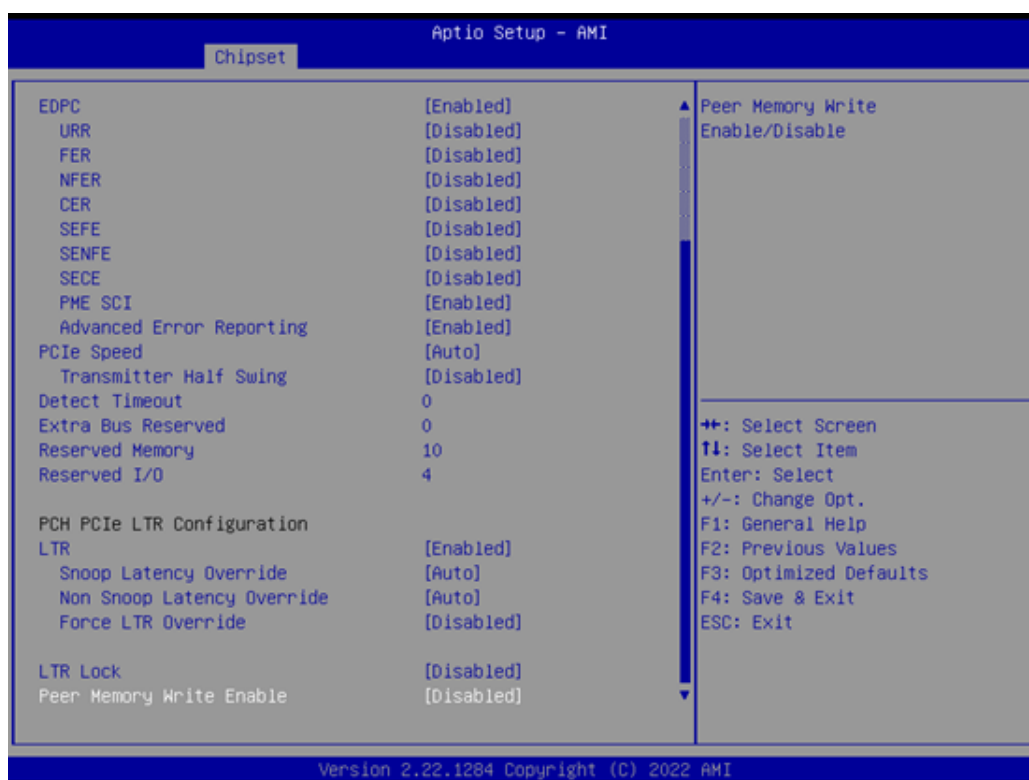
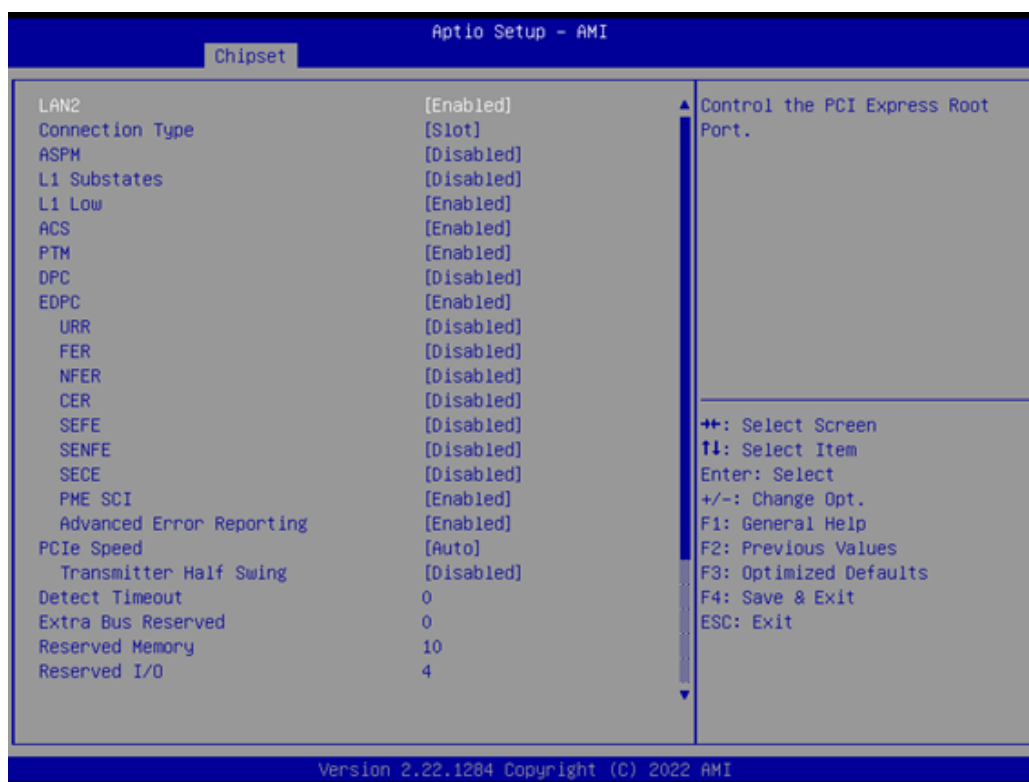

M.2 M-Key

Chipset → PCH-IO Configuration → PCI Express Configuration → M.2 M-Key

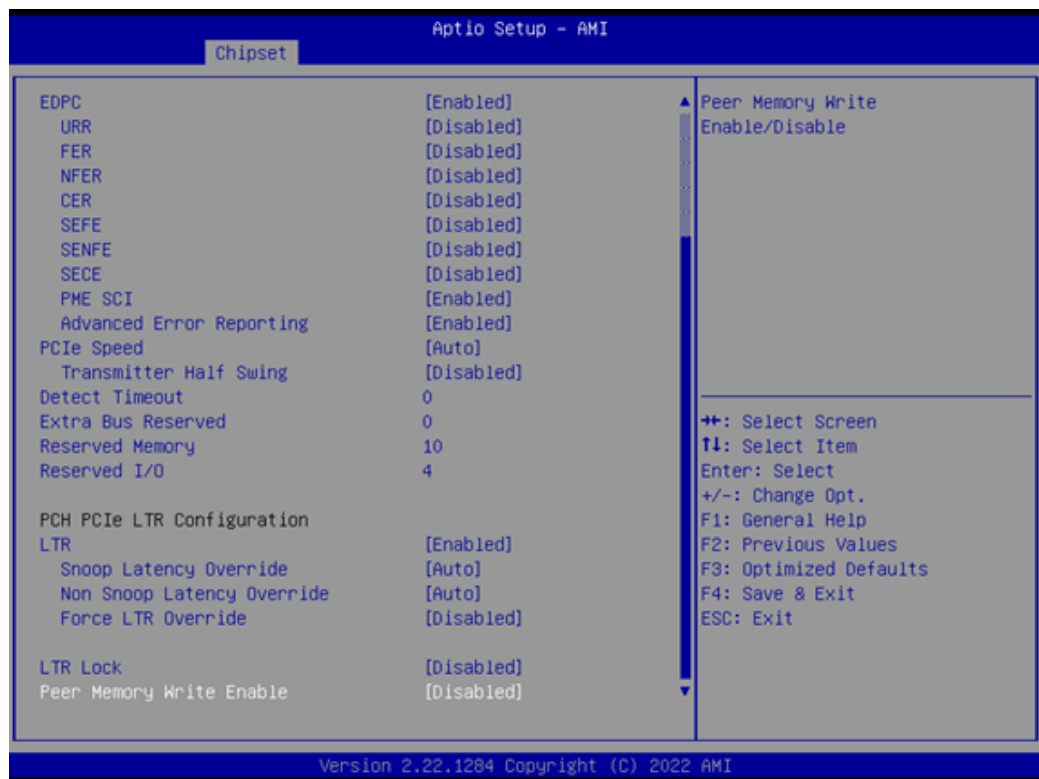
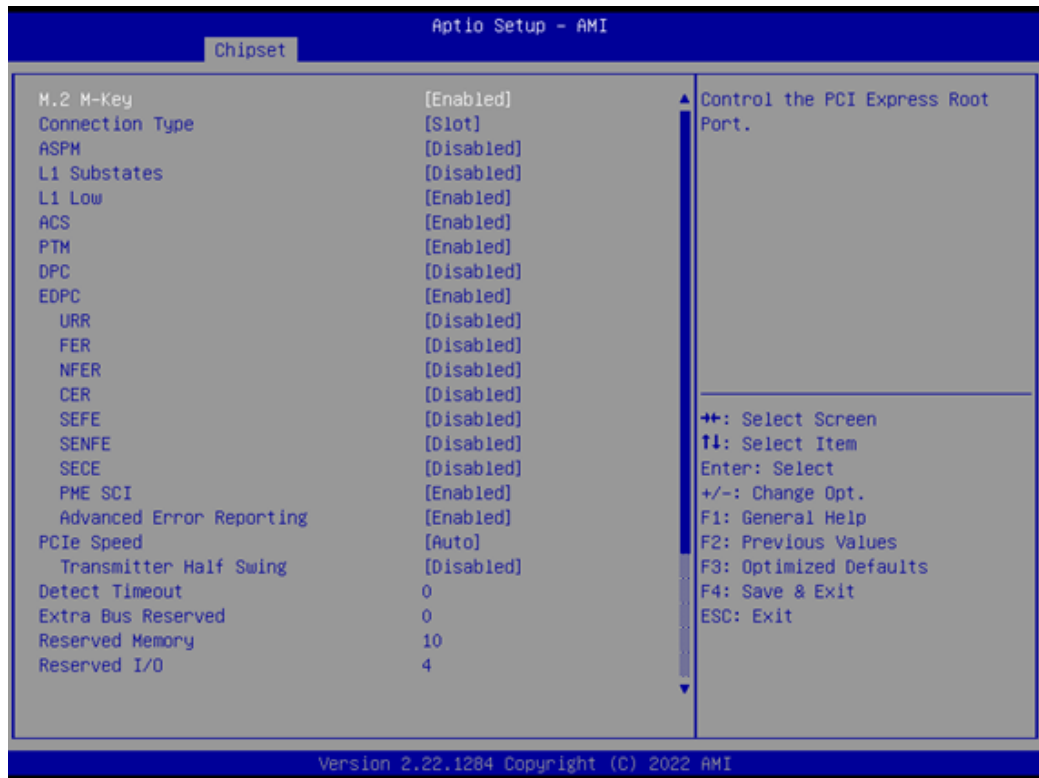

SATA Configuration

Chipset → PCH-IO Configuration → SATA Configuration

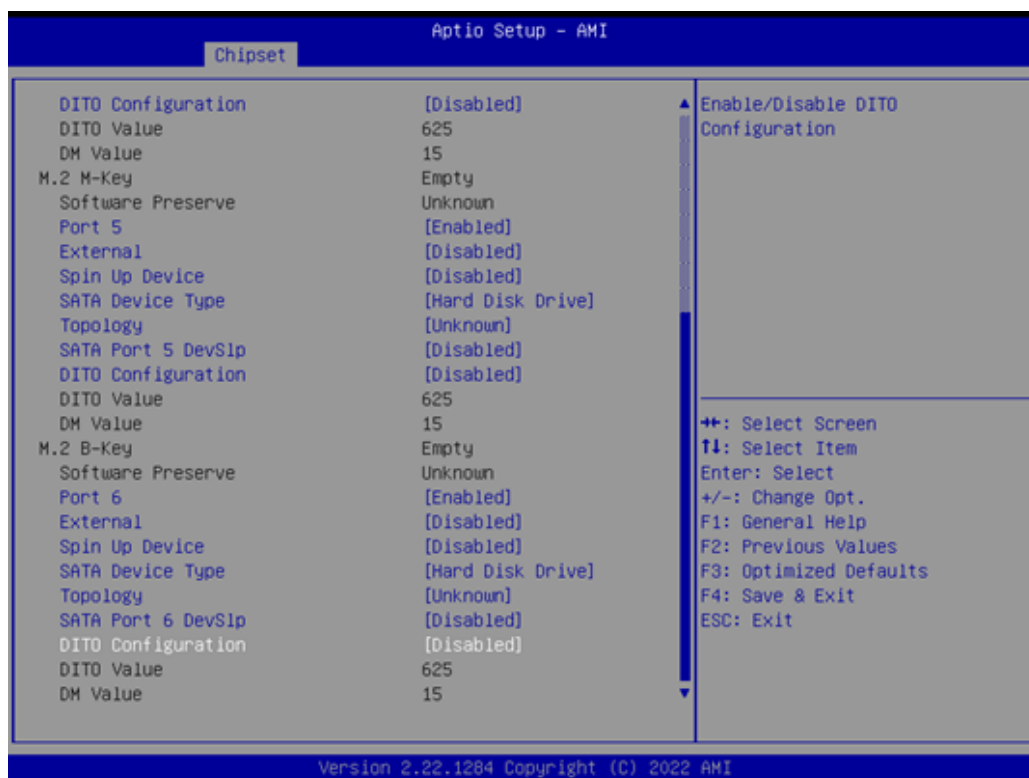
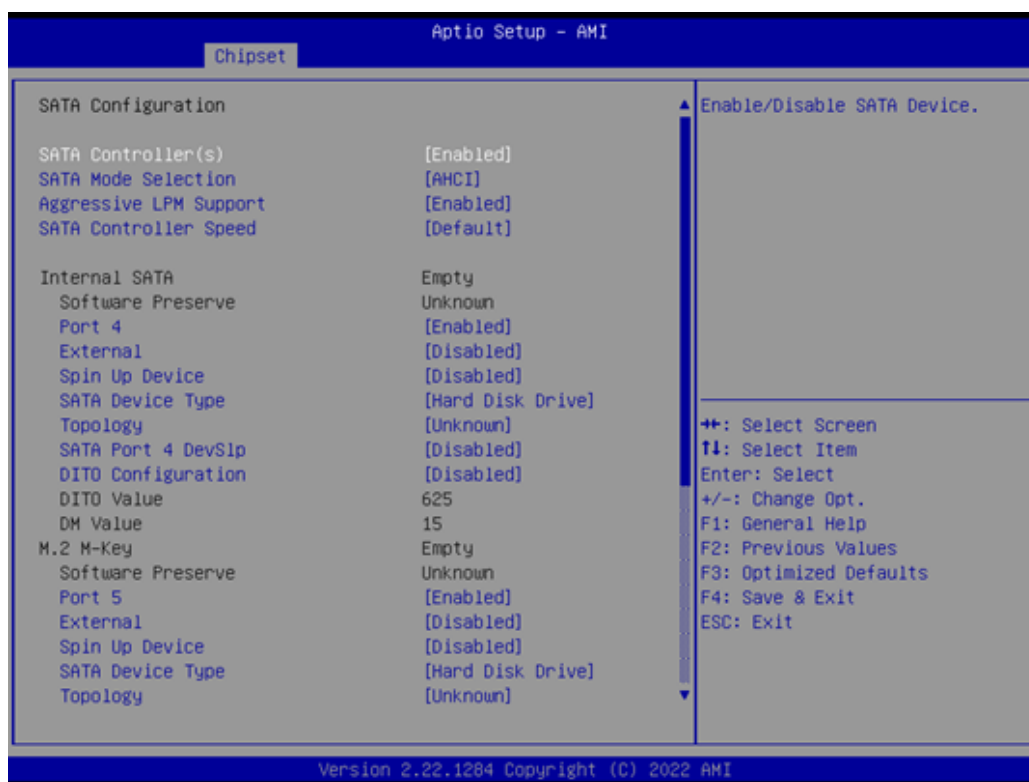

Security Configuration

Chipset → PCH-IO Configuration → Security Configuration

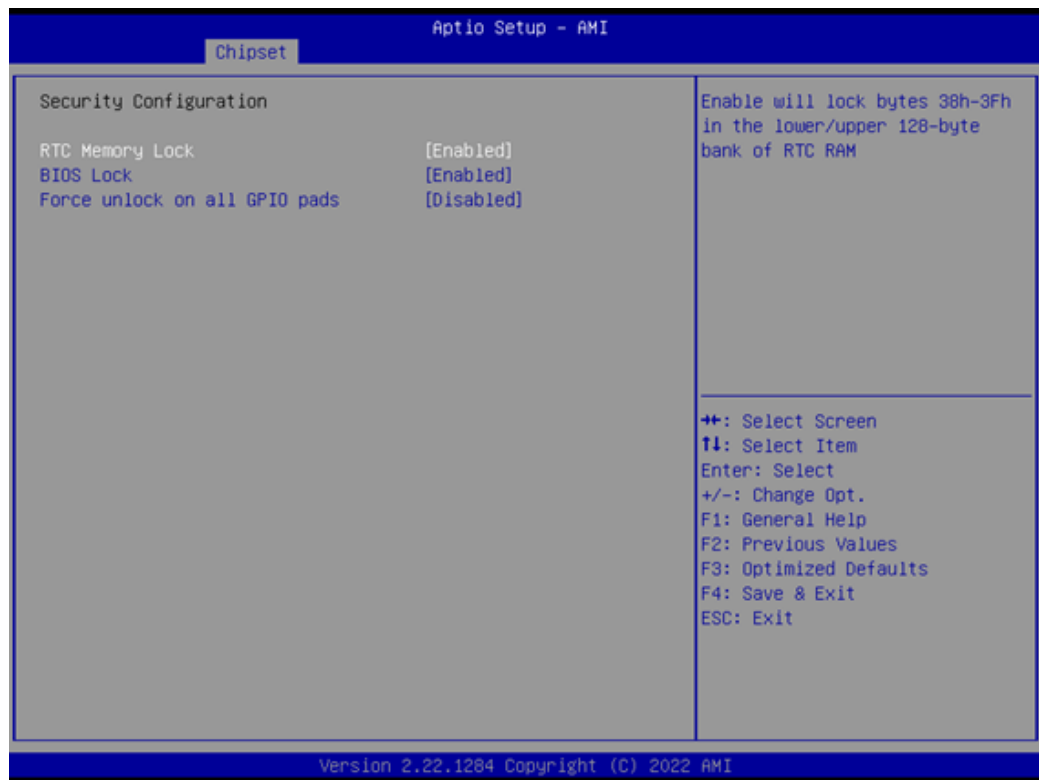

HD Audio Subsystem Configuration Settings

Chipset → PCH-IO Configuration → HD Audio Subsystem Configuration Settings



3.2.4 Security



- **Administrator Password**
Select this option and press <ENTER> to access the sub-menu, and then type in the password. Set the administrator password.
- **User Password**
Select this option and press <ENTER> to access the sub-menu, and then type in the password. Set the user password.

Secure Boot

Security → Secure Boot



3.2.5 Boot Settings

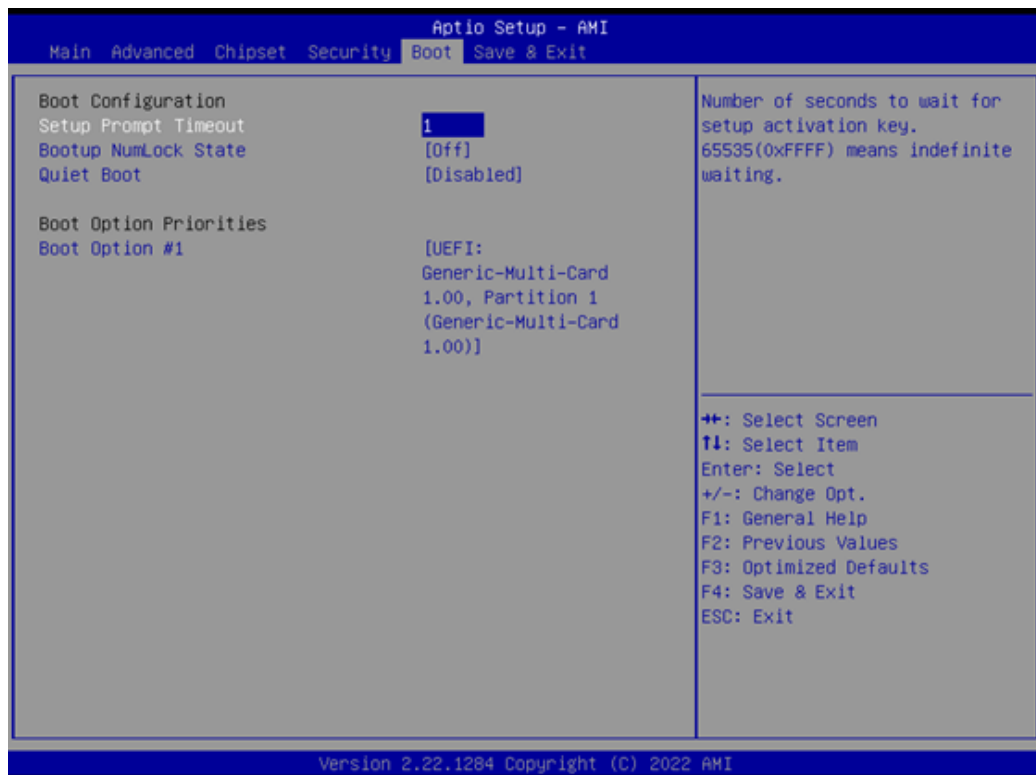

- **Setup Prompt Timeout**
User the <+> and <-> keys to adjust the number of seconds to wait for the setup activation key.
- **Bootup NumLock State [Off]**
Set the power to the On or Off state for the NumLock.
- **Quiet Boot [Disabled]**
If this option is set to disabled, the BIOS displays normal POST messages. If enabled, an OEM logo is shown instead of POST messages.

3.2.6 Save & Exit Configuration

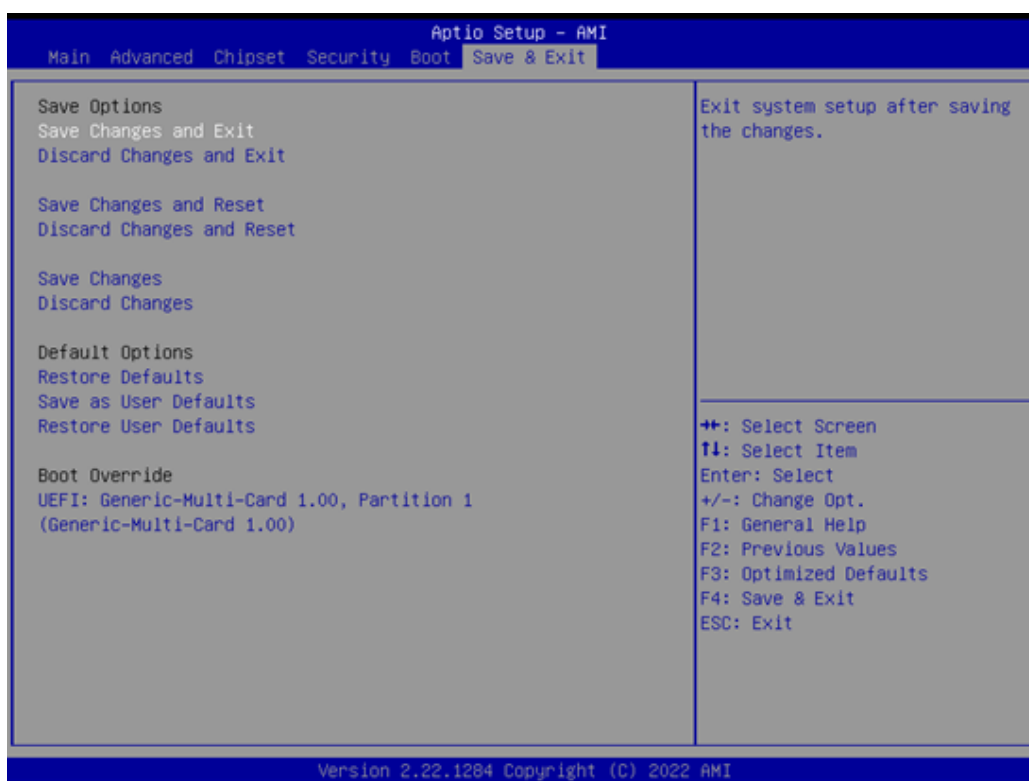

- **Save Changes and Exit**
When users have completed system configuration, select this option to save changes, exit the BIOS setup menu and reboot the computer for the changes to take effect on all system configuration parameters.
 1. Select Save Changes and Exit from the Save & Exit menu and press <Enter>. The following message appears: Save Configuration Changes and Exit Now?
 2. Select [Ok] or [Cancel].
- **Discard Changes and Exit**
Select this option to quit setup without making any permanent changes to the system configuration.
 1. Select Discard Changes and Exit from the Save & Exit menu and press <Enter>. The following message appears: Discard Changes and Exit Setup now? [Ok] or [Cancel]
 2. Select Ok to discard changes and exit.
- **Save Changes and Reset**

When users have completed system configuration, select this option to save changes, exit the BIOS setup menu, and reboot the computer for changes to take effect.

1. Select Save Changes and Reset from the Save & Exit menu and press <Enter>. The following message appears: Save Configuration Changes and Exit Now? [Ok] or [Cancel]

2. Select [Ok] or [Cancel].

- **Discard Changes and Reset**

Select this option to quit Setup without making any permanent changes to the system configuration.

1. Select Discard Changes and Reset from the Save & Exit menu and press <Enter>. The following message appears: Discard Changes and Exit Setup Now? [Ok] or [Cancel]

2. Select Ok to discard changes and reset.

- **Restore Default**

The BIOS automatically configures all setup items to optimal settings when users select this option. Defaults are designed for maximum system performance but may not work best for all computer applications. In particular, do not use the defaults if the user's computer is experiencing system configuration problems. Select Restore Defaults from the Exit menu and press <Enter>.

- **Save as User Default**

Saves all current settings as a user default.

- **Restore User Default**

Restores all settings to user default values.

- **Boot Override**

Shows the boot device types on the system.

Chapter 4

Software Introduction
& Service

4.1 Introduction

The mission of Advantech Embedded Software Services is to "Enhance quality of life with Advantech platforms and Microsoft® Windows® embedded technology." We enable Windows® Embedded software products on Advantech platforms to more effectively support the embedded computing community. Customers are freed from the hassle of dealing with multiple vendors (hardware suppliers, system integrators, embedded OS distributors) for projects. Our goal is to make Windows® Embedded Software solutions easily and widely available to the embedded computing community.

4.2 Value-Added Software Services

Software API: An interface that defines the ways by which an application program may request services from libraries and/or operating systems. It provides the underlying drivers required and also brings a rich set of user-friendly, intelligent and integrated interfaces to speed development, enhance security, and offer add-on value to Advantech platforms. It plays the role of catalyst between developer and solution, and makes Advantech embedded platforms easier and simpler to adopt and operate within customer applications.

4.2.1 Software API

4.2.1.1 Control

GP I/O



General Purpose Input/Output is a flexible parallel interface that allows a variety of custom connections. It allows users to monitor the level of signal input or set the output status to switch the device on/off. Our API also provides Programmable GPIO, which allows developers to dynamically set the GPIO input or output status.

SMBus



SMBus is the System Management Bus defined by Intel Corporation in 1995. It is used in personal computers and servers for low-speed system management communications. The SMBus API allows a developer to interface with an embedded system environment and transfer serial messages using the SMBus protocols, allowing multiple simultaneous device control.

4.2.1.2 Display

Brightness Control



The Brightness Control API allows a developer to access embedded devices and easily control brightness.

Backlight



The Backlight API allows a developer to control the backlight (screen) on/off in embedded devices.

4.2.1.3 Monitor

Watchdog



A watchdog timer (WDT) is a device that performs a specific operation after a certain period of time if something goes wrong and the system does not recover on its own. A watchdog timer can be programmed to perform a warm boot (restarting the system) after a certain number of seconds.

Hardware Monitor



The Hardware Monitor (HWM) API is a system health supervision API that inspects certain condition indexes, such as fan speed, temperature, and voltage.

4.2.1.4 Power Saving

CPU Speed



Intel® SpeedStep BIOS technology is used to save power consumption. The system will automatically adjust the CPU speed depending on the system loading.

System Throttling



System throttling refers to a series of methods for reducing power consumption in computers by lowering the clock frequency. This API allows the user to adjust the clock from 87.5% to 12.5%.

4.2.2 Software Utility

BIOS Flash

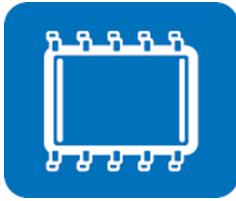

The BIOS Flash utility allows customers to update the flash ROM BIOS version, or use it to back up the current BIOS by copying it from the flash chip to a file on a customer's disk. The BIOS Flash utility also provides a command line version and an API for fast implementation into customized applications.

Embedded Security ID



The embedded application is the most important property of a system integrator. It contains valuable intellectual property, design knowledge and innovation, but this makes it vulnerable! The Embedded Security ID utility provides reliable security functions for customers to secure their application data within the embedded BIOS.

Monitoring



Monitoring is a utility for customers to monitor aspects of system health like voltage, CPU and system temperature, and fan speed. These items are important to a device. If critical errors occur and are not solved immediately, permanent damage may be caused.

Chapter 5

Chipset Software
Installation Utility

5.1 Before You Begin

To facilitate the installation of the enhanced display drivers and utility software, read the instructions in this chapter carefully. The drivers for the AIMB-288E are located on the Advantech support website: <http://support.advantech.com/support>. The drivers on the support website will guide and link you to the utilities and drivers under a Windows system. Updates are provided via Service Packs from Microsoft*.

Note! *The driver files on the website are compressed. Do not attempt to install the drivers by copying the files manually. You must download the files and decompress them first. Also, please use the supplied SETUP program to install the drivers.*



Before you begin, it is important to note that most display drivers need to have the relevant software application already installed in the system prior to installing the enhanced display drivers. In addition, many of the installation procedures assume that you are familiar with both the relevant software applications and operating system commands. Review the relevant operating system commands and the pertinent sections of your application software's user manual before performing the installation.

5.2 Introduction

The Intel® Chipset Software Installation (CSI) utility installs the Windows INF files that outline to the operating system how the chipset components will be configured. This is needed for the proper functioning of the following features:

- **Core PCI PnP services**
- **Serial ATA interface support**
- **USB support**
- **Identification of Intel® chipset components in the Device Manager**

Note! *This utility is used for the following versions of Windows, and it has to be installed before installing all the other drivers:*



- **Windows 10 (64-bit)**

Chapter 6

VGA Setup

6.1 Introduction

The AIMB-288E is embedded with an integrated Nvidia T1000 MXM GPU card. You need to install the T1000 driver to enable the function.

Optimized integrated graphics solution: the Intel® Flexible Display Interface supports versatile display options and a 32-bit 3D graphics engine. Dual independent displays include enhanced display modes for widescreen flat panels for extended, twin, clone, and dual display modes, and optimized 3D support delivers an intensive and realistic visual experience.

6.2 Windows 10 T1000 Driver Installation

Note! Before installing this driver, make sure the CSI utility has been installed in your system. See Chapter 5 for information on installing the CSI utility.



Download the driver from the website to your computer. Navigate to the “AIMB-288E_Graphic_Win10 (64-bit)” folder and click “setup.exe” to complete the installation of the drivers for Windows 10.

Win10 driver for AIMB-288E

2022-12-05 | Driver | Document No.1-5031909771

Related Product:
AIMB-288E

Solution:

Driver Name	Date	Action
AIMB-288E_Chipset_Win10(32_64bit)	2022-11-29	Download
AIMB-288E_Graphic_Win10(64bit)	2022-11-29	Download
AIMB-288E_LAN_Win10(64bit)	2022-11-30	Download
AIMB-288E_ME_Win10(64bit)	2022-11-30	Download
AIMB-288E_Audio1_Win10(64bit)	2022-11-30	Download

Chapter 7

LAN Configuration

7.1 Introduction

The AIMB-288E has two Gigabit Ethernet LANs via dedicated PCI Express x1 lanes, Intel® i226V and I219LM (Phy), that offer bandwidth of up to 500 MB/sec, eliminating the bottleneck of network data flow and incorporating Gigabit Ethernet at 1000 Mbps.

7.2 Features

- Integrated 10/100/1000 Mbps transceiver
- 10/100/1000 Mbps triple-speed MAC
- High-speed RISC core with 24-KB cache
- On-chip voltage regulation
- Wake-on-LAN (WOL) support
- PCI Express X1 host interface

7.3 Installation

Note! *Before installing this driver, make sure the CSI utility has been installed in your system. See Chapter 5 for information on installing the CSI utility.*



The AIMB-288E's Intel® i226V and Intel® i219LM Gigabit integrated controllers support all major network operating systems. However, the installation procedure varies from system to system. Please find and use the section that provides the driver setup procedure for the OS you are using.

7.4 Windows® 10 Driver Setup (Intel® i219LM & Intel® i226V)

Download the driver from the support website to your computer and decompress the file. Select “Autorun”, then navigate to the directory for your OS.

Note! Before installing this driver, make sure the CSI utility has been installed in your system. See Chapter 5 for information on installing the CSI utility.



Win10 driver for AIMB-288E

2022-12-05 | Driver | Document No.1-5031909771

Related Product:

AIMB-288E

Solution:

Win10 driver for AIMB-288E

Win10 driver for AIMB-288E

AIMB-288E_Chipset_Win10(32_64bit) 2022-11-29	Download
AIMB-288E_Graphic_Win10(64bit) 2022-11-29	Download
AIMB-288E_LAN_Win10(64bit) 2022-11-30	Download
AIMB-288E_ME_Win10(64bit) 2022-11-30	Download
AIMB-288E_Audio1_Win10(64bit) 2022-11-30	Download

ADVANTECH

Enabling an Intelligent Planet

www.advantech.com

Please verify specifications before quoting. This guide is intended for reference purposes only.

All product specifications are subject to change without notice.

No part of this publication may be reproduced in any form or by any means, electronic, photocopying, recording or otherwise, without prior written permission from the publisher.

All brand and product names are trademarks or registered trademarks of their respective companies.

©Advantech Co., Ltd. 2023