

## ITA-5710 Series Intel® Atom D525 Fanless Compact System with 2 x M12 GigaLAN, 2 x M12 USB and Dual Display Fully Compliant with EN 50155

### Startup Manual

#### Packing List

Before you begin installing your IPC, please make sure that the following items have been shipped:

1. 1 x ITA-5710 series IPC
2. 1 x Accessory box
3. 1 x Warranty card

If any of these items are missing or damaged, please contact your distributor or sales representative immediately.

**Note 1:** For detailed contents of ITA-5710, please refer to information on the enclosed CD-ROM (in PDF format).

**Note 2:** Acrobat Reader is required to view any PDF file. Acrobat Reader can be downloaded at: [www.adobe.com/Products/acrobat/readstep2.html](http://www.adobe.com/Products/acrobat/readstep2.html) (Acrobat is a trademark of Adobe)

#### Specifications

##### Standard Functions

- **Chip and chipset:** Intel Atom processor D525 and Intel ICH8M chipset
- **BIOS:** AMI SPI 16 MB Flash
- **Memory:** Onboard 2 GB DDR3 800/667 memory
- **Display:** Embedded Gen3.5+GFX Core, Frequency 400 MHz. Shared system memory up to 256 MB SDRAM
- **Dual display mode:**
  - Resolution of single display up to 2048 x 1536
  - Resolution of dual display up to 1366 x 768
- **CF interface:** Supports 1 CompactFlash socket
- **Expansion slot:** Support 2 mini-PCIe slot/1 PCI slot/1 PCIe x1 slot

##### System Specifications

- **Ethernet:** 2 x 10/100/1000M Ethernet, M12 A-coded(F) 8-pin (Controller chip: Intel i210-IT)
- **USB:**
  - 2 x USB2.0 with M12 A-coded(F) 4-pin
  - 6 x USB2.0 with Type A
- **VGA:** 2 VGA connectors
- **Serial port:** 2 serial ports, with RS-232/422/485
- **Audio:** 1 speaker out (supports 2-ch 4w speaker), 1 line in; DB9 connector

##### Mechanical and Environment

- **Dimensions (W x H x D):** 210 x 129 x 240 mm  
253 x 133 x 240 mm (with ears)
- **Voltage input:** DC 24V/48V/72V/110V, compliance with EN50155
- **Operating temperature:** -40 ~ 60° C (-40 ~ 140° F)
- **Weight:** 4.5 kg

For more information on this and other Advantech products, please visit our website at:

<http://www.advantech.com>

<http://www.advantech.com/eplatform>

For technical support and service, please visit our support website at:

<http://support.advantech.com>

This manual is for the ITA-5710 Series.

Part No. 200K571010  
Print in China

1st Edition  
June 2014

# Jumpers

## Jumper Setting

The board has a number of jumpers that allow you to configure your system to suit your application.

The table below lists the function of each of the jumpers.

Name/Function	
JLVDS1	LVDS voltage setting
JCMOS1	Clear CMOS setting
VCC_GPIO1	GPIO voltage setting
PSON1	Power on mode setting

JLVDS1: LVDS Voltage Setting	
Pins	Setting
1-2	+V5
2-3	Normal (+V3.3)*
* Default setting	

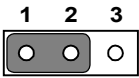

+V5

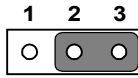

+V3.3

JCMOS1: Clear CMOS Setting	
Pins	Setting
1-2	Default*
2-3	Clear CMOS setting
* Default setting	

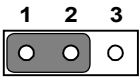

Default Setting

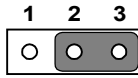

Clear CMOS Setting

VCC_GPIO1: GPIO Voltage Setting	
Pins	Setting
1-2	+V5_SB
2-3	Normal (+V3.3_SB)*
* Default setting	

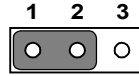

+V5\_SB

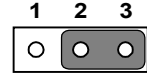

+V3.3\_SB

PSON1: Power On Mode Setting	
Pins	Setting
1-2	AT mode
2-3	ATX mode*
* Default setting	

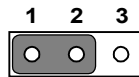

AT Mode

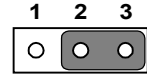

ATX Mode

## Connector Definition

### USB Connector Definition

The IPC has 2 M12 type USB2.0 connectors. The definition is as follows:

USB	
Pin	Signal Name
1	D-
2	5V
3	D+
4	GND



### Power Connector Definition

ITA-5730 provides 24V/48V/72V/110V DC voltage input.

Power Connector	
Pin	Signal Name
1	GND
2	Power
3	Power
4	GND



### LED Definition

At the top right corner on the rear side, there are 3 LEDs indicating the operating status.

LED Status	
LED Status	
Storage LED	Orange
Power LED	Green
Alarm LED	Red

### Ethernet LED Definition

The IPC has 2 M12 type Ethernet connectors.

Ethernet Connector	
Pin	Signal Name
1	MDI2+
2	MDI3+
3	MDI3-
4	MDI0-
5	MDI1+
6	MDI0+
7	MDI2-
8	MDI1-

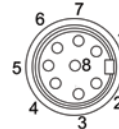

## Safety Instructions

1. Read these safety instructions carefully.
2. Keep this User Manual for later reference.
3. Disconnect this equipment from any AC outlet before cleaning. Use a damp cloth. Do not use liquid or spray detergents for cleaning.
4. For plug-in equipment, the power outlet socket must be located near the equipment and must be easily accessible.
5. Keep this equipment away from humidity.
6. Put this equipment on a reliable surface during installation. Dropping it or letting it fall may cause damage.
7. Make sure the voltage of the power source is correct before connecting the equipment to the power outlet.
8. Position the power cord so that people cannot step on it. Do not place anything over the power cord.
9. All cautions and warnings on the equipment should be noted.
10. If the equipment is not used for a long time, disconnect it from the power source to avoid damage by transient overvoltage.
11. Never pour any liquid into an opening. This may cause fire or electrical shock.
12. Never open the equipment. For safety reasons, the equipment should be opened only by qualified service personnel.
13. If one of the following situations arises, get the equipment checked by service personnel:
  - The power cord or plug is damaged.
  - Liquid has penetrated into the equipment.
  - The equipment has been exposed to moisture.
  - The equipment does not work well, or you cannot get it to work according to the user's manual.
  - The equipment has been dropped and damaged.
  - The equipment has obvious signs of breakage.
14. Do not leave this equipment in an environment where the storage temperature may go below  $-40^{\circ}\text{C}$  ( $-40^{\circ}\text{F}$ ) or above  $60^{\circ}\text{C}$  ( $140^{\circ}\text{F}$ ). This could damage the equipment. The equipment should be in a controlled environment.
15. **Caution:** Danger of explosion if battery is incorrectly replaced. Deplace only with the same or equivalent type recommended by the manufacturer, discard used batteries according to the manufacturer's instructions.
16. This equipment has been tested and found to comply with the limits for Class A digital device. Operation of this equipment in a residential area is likely to cause harmful interference to radio communications in which case the user will be required to correct the interference.
17. This equipment is sold without power cord. It is recommended to purchase CCC certificated power cord.

The sound pressure level at the operator's position according to IEC 704-1:1982 is no more than 70 dB (A).

DISCLAIMER: This set of instructions is given according to IEC 704-1. Advantech disclaims all responsibility for the accuracy of any statements contained herein.

## Safety Precaution - Static Electricity

Follow these simple precautions to protect yourself from harm and the products from damage.

1. To avoid electrical shock, always disconnect the power from your PC chassis before you work on it.
2. Disconnect power before making any configuration changes. The sudden rush of power as you connect a jumper or install a card may damage sensitive electronic components.
3. Always disconnect the power cord from your chassis when you are working on it. Do not connect while the power is on. A sudden rush of power can damage sensitive electronic components. Only experienced electronics personnel should open the chassis. Always ground yourself to remove any static electric charge before touching motherboard, backplane or add-on cards. Modern electronic devices are very sensitive to static electric charges. Use a grounding wrist strap at all times. Place all electronic components on a static-dissipative surface or in a static shielded bag.

## Installation Notes

When the equipment is running, please avoid any covering above the heat sink within 30mm in case that it impacts the air flow circuiting.

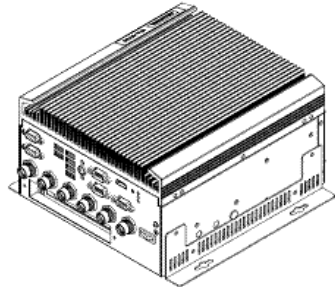

When the equipment is wall-mounted installed, please keep the fin direction parallel to the air flow direction and it can greatly improve the cooling efficiency.

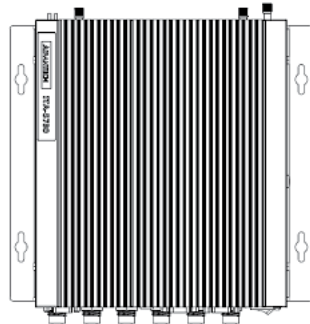

# System Dimension

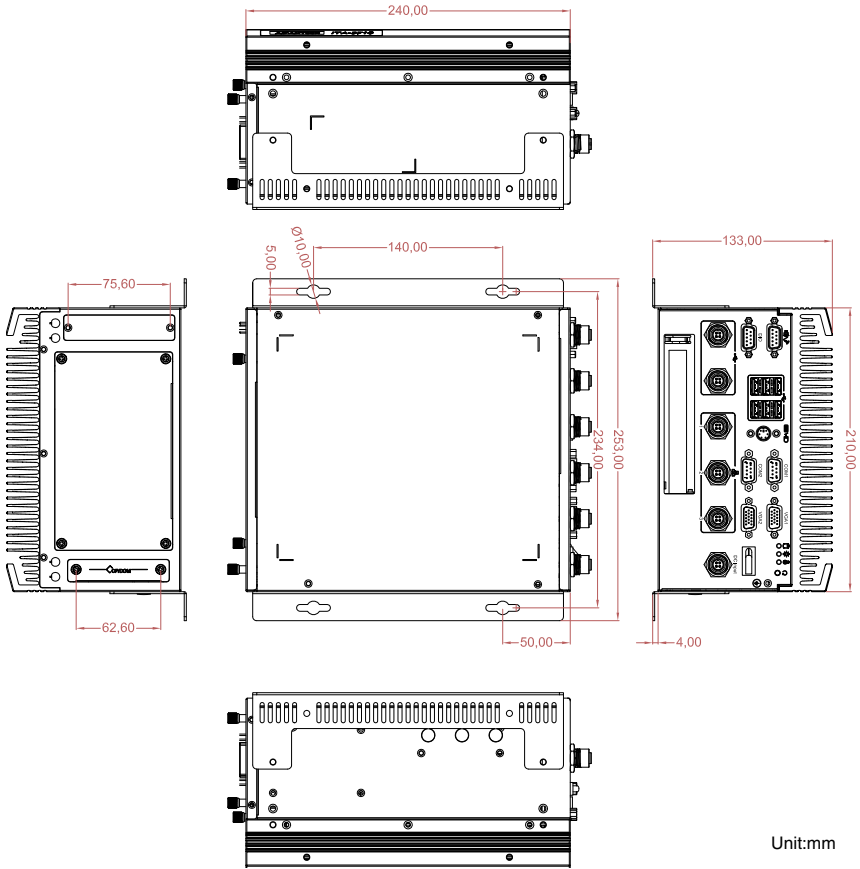

Unit:mm

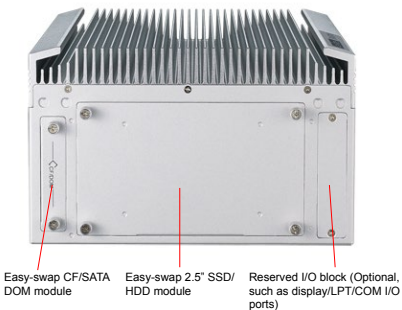

Front view

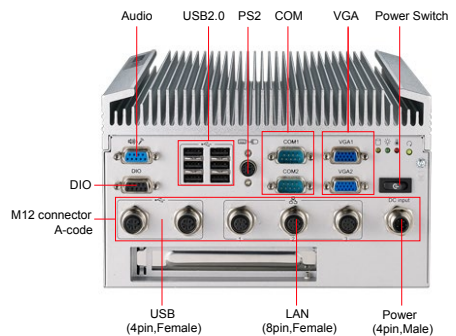

Rear view