

Advantech

AQD-D5V8GN56-SCH

Datasheet

Rev. 1.0

2024-04-01

Description

DDR5 1.1V Unbuffered DIMM is high-speed, low power memory module that use 1Gx16 bits DDR5 SDRAM in FBGA package and a 8192 bits serial EEPROM on a 288-pin printed circuit board. DDR5 1.1V Unbuffered DIMM is a Dual In-Line Memory Module and is intended for mounting into 288-pin edge connector sockets.

Synchronous design allows precise cycle control with the use of system clock. Data I/O transactions are possible on both edges of DQS. Range of operation frequencies, programmable latencies allow the same device to be useful for a variety of high bandwidth, high performance memory system applications.

Features

- JEDEC standard compliant
- On-DIMM thermal sensor : Yes
- VDD = VDDQ= 1.1V (1.067V to 1.166V)
- VPP = 1.8V (1.746V to 1.908V) · VDDSPD = 1.8V
- 32 internal banks (x4, x8): 8 groups of 4 banks each
- 16 internal banks (x16): 4 groups of 4 banks each
- CAS Latency (CL): 22,26,28,30,32,36,40,42,46,48,50
- CAS Write Latency (CWL): RL-2
- Operating temperature Tcase-(0°C~85°C)
- Average Refresh period 3.9us at lower than Tcase 85°C, 1.95us at 85°C < Tcase < 95 °C.
- All bank and same bank refresh
- Bi-Directional Differential Data Strobe
- 16-bit prefetch architecture
- On-die ECC
- ECC transparency and error scrub
- sPPR and hPPR capability
- PCB: 30μ inch gold finger
- Halogen free · Lead-free (RoHS compliant)
- Anti-Sulfuration (Anti-FOS test: ASTM-B809-95)

Pin Identification

Symbol	Function
CA0_A – CA12_A, CA0_B – CA12_B	SDRAM Command/Address bus
CS0_A_n – CS1_A_n, CS0_B_n – CS1_B_n	SDRAM Chip Select
DQ0_A – DQ31_A, DQ0_B – DQ31_B	DIMM memory data bus
CB0_A – CB3_A, CB0_B – CB3_B	DIMM ECC check bits (Only applicable on ECC SODIMM or ECC UDIMM)
DQS0_A_t – DQS4_A_t, DQS0_B_t – DQS4_B_t	SDRAM data strobes (positive line of differential pair)
DQS0_A_c – DQS4_A_c, DQS0_B_c – DQS4_B_c	SDRAM data strobes (negative line of differential pair)
DM0_A_n – DM3_A_n, DM0_B_n – DM3_B_n	SDRAM data masks
CK0_A_t, CK1_A_t, CK0_B_t, CK1_B_t	SDRAM clocks (positive line of differential pair)
CK0_A_c, CK1_A_c, CK0_B_c, CK1_B_c	SDRAM clocks (negative line of differential pair)
HSC_L	Side Band bus clock
HSDA	Side Band bus data
HSA	Side Band bus address
ALERT_n	SDRAM ALERT_n
RESET_n	Set DRAMs to a Known State
VIN_BULK	5 V power input supply to the PMIC for analog circuits
VSS	Power supply return (ground)
PWR_GOOD	Power good indicator
PWR_EN	PMIC Enable
RFU	Reserved for future use

*Notes:

DDR5 UDIMM has 2 channels (channel-A and channel-B) of signal bus.

The signals with suffix: _A (e.g. DQ0_A) are for channel-A, and the signals with suffix: _B (e.g. DQ0_B) are for channel-B

Dimensions (Unit: millimeter)

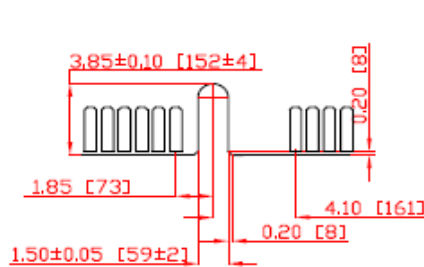
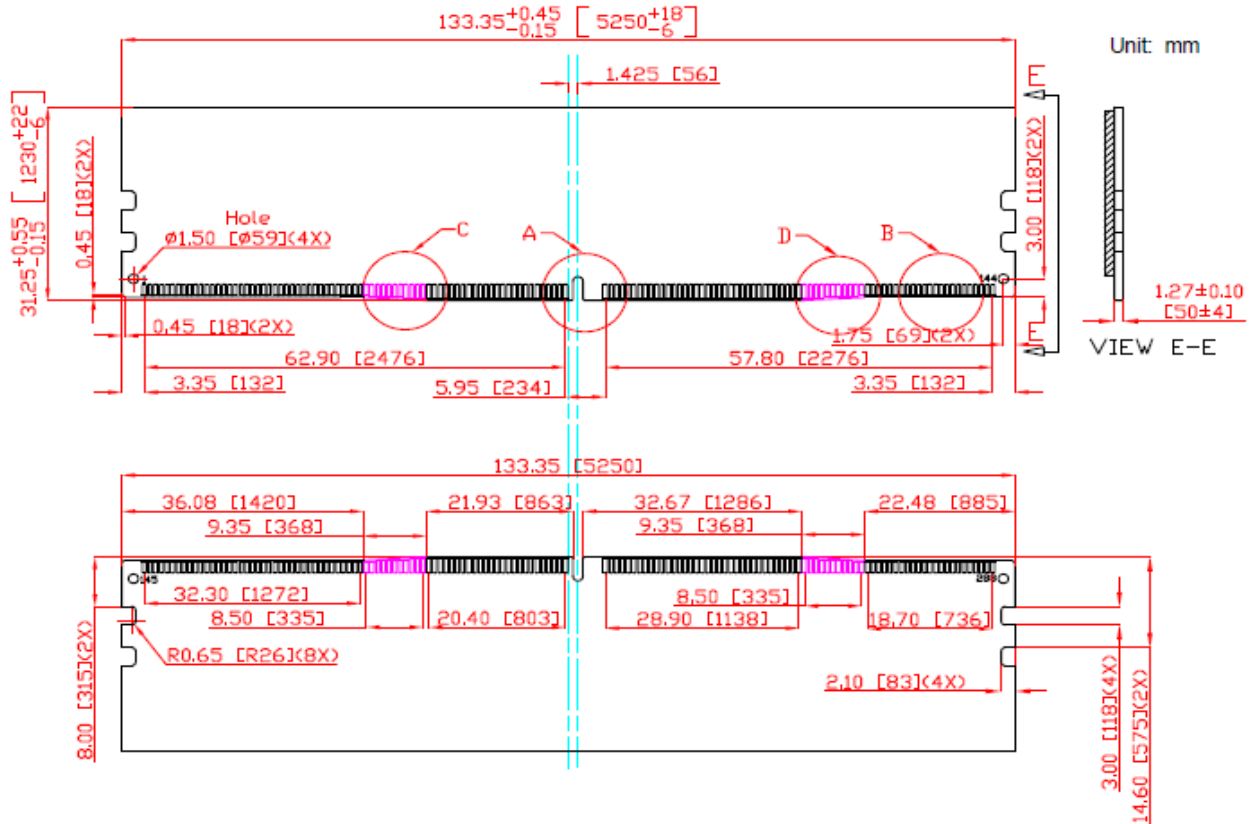

Detail A

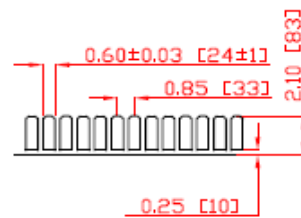

Detail B

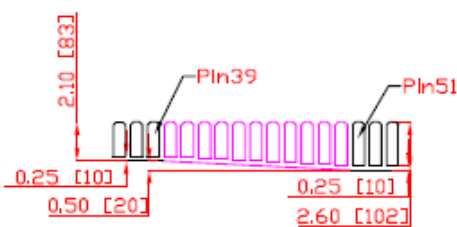

Detail C

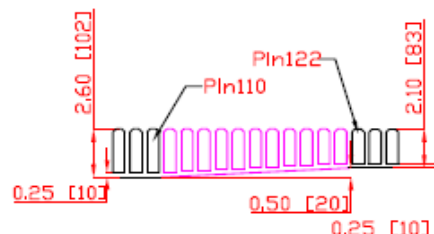

Detail D

30µ inch gold finger

(All dimensions are in millimeters with ±0.15mm tolerance unless specified otherwise.)

Pin Assignments

Pin No.	Front Side	Pin No.	Back Side	Pin No.	Front Side	Pin No.	Back Side
1	VIN_BULK	145	VIN_BULK	74	VSS	218	VSS
2	RFU	146	VIN_BULK	75	RFU	219	RFU
3	RFU	147	PWR - GOOD	76	RFU	220	RFU
4	HSCCL	148	HSA	77	VSS	221	VSS
5	HSDA	149	RFU	78	CK0_B_t	222	CK1_B_t
6	VSS	150	VSS	79	CK0_B_c	223	CK1_B_c
7	RFU	151	PWR_EN	80	VSS	224	VSS
8	VSS	152	RFU	81	RFU	225	RFU
9	DQ0_A	153	VSS	82	CA12_B	226	RFU
10	VSS	154	DQ2_A	83	VSS	227	VSS
11	DQ1_A	155	VSS	84	CA10_B	228	CA11_B
12	VSS	156	DQ3_A	85	CA8_B	229	CA9_B
13	DQS0_A_c	157	VSS	86	VSS	230	VSS
14	DQS0_A_t	158	DM0_A_n	87	CA6_B	231	CA7_B
15	VSS	159	VSS	88	CA4_B	232	CA5_B
16	DQ4_A	160	DQ6_A	89	VSS	233	VSS
17	VSS	161	VSS	90	CA2_B	234	CA3_B
18	DQ5_A	162	DQ7_A	91	CA0_B	235	CA1_B
19	VSS	163	VSS	92	VSS	236	VSS
20	DQ8_A	164	DQ10_A	93	CS0_B_n	237	CS1_B_n
21	VSS	165	VSS	94	VSS	238	VSS
22	DQ9_A	166	DQ11_A	95	RESET_n	239	DQS4_B_c
23	VSS	167	VSS	96	VSS	240	DQS4_B_t
24	DM1_A_n	168	DQS1_A_c	97	CB0_B	241	VSS
25	VSS	169	DQS1_A_t	98	VSS	242	CB2_B
26	DQ12_A	170	VSS	99	CB1_B	243	VSS
27	VSS	171	DQ14_A	100	VSS	244	CB3_B
28	DQ13_A	172	VSS	101	DQ0_B	245	VSS
29	VSS	173	DQ15_A	102	VSS	246	DQ2_B
30	DQ16_A	174	VSS	103	DQ1_B	247	VSS
31	VSS	175	DQ18_A	104	VSS	248	DQ3_B
32	DQ17_A	176	VSS	105	DQS0_B_c	249	VSS
33	VSS	177	DQ19_A	106	DQS0_B_t	250	DM0_B_n
34	DQS2_A_c	178	VSS	107	VSS	251	VSS
35	DQS2_A_t	179	DM2_A_n	108	DQ4_B	252	DQ6_B
36	VSS	180	VSS	109	VSS	253	VSS
37	DQ20_A	181	DQ22_A	110	DQ5_B	254	DQ7_B
38	VSS	182	VSS	111	VSS	255	VSS
39	DQ21_A	183	DQ23_A	112	DQ8_B	256	DQ10_B

Pin No.	Front Side	Pin No.	Back Side	Pin No.	Front Side	Pin No.	Back Side
40	VSS	184	VSS	113	VSS	257	VSS
41	DQ24_A	185	DQ26_A	114	DQ9_B	258	DQ11_B
42	VSS	186	VSS	115	VSS	259	VSS
43	DQ25_A	187	DQ27_A	116	DM1_B_n	260	DQS1_B_c
44	VSS	188	VSS	117	VSS	261	DQS1_B_t
45	DM3_A_n	189	DQS3_A_c	118	DQ12_B	262	VSS
46	VSS	190	DQS3_A_t	119	VSS	263	DQ14_B
47	DQ28_A	191	VSS	120	DQ13_B	264	VSS
48	VSS	192	DQ30_A	121	VSS	265	DQ15_B
49	DQ29_A	193	VSS	122	DQ16_B	266	VSS
50	VSS	194	DQ31_A	123	VSS	267	DQ18_B
51	CB0_A	195	VSS	124	DQ17_B	268	VSS
52	VSS	196	CB2_A	125	VSS	269	DQ19_B
53	CB1_A	197	VSS	126	DQS2_B_c	270	VSS
54	VSS	198	CB3_A	127	DQS2_B_t	271	DM2_B_n
55	DQS4_A_c	199	VSS	128	VSS	272	VSS
56	DQS4_A_t	200	ALERT_n	129	DQ20_B	273	DQ22_B
57	VSS	201	VSS	130	VSS	274	VSS
58	CS0_A_n	202	CS1_A_n	131	DQ21_B	275	DQ23_B
59	VSS	203	VSS	132	VSS	276	VSS
60	CA0_A	204	CA1_A	133	DQ24_B	277	DQ26_B
61	CA2_A	205	CA3_A	134	VSS	278	VSS
62	VSS	206	VSS	135	DQ25_B	279	DQ27_B
63	CA4_A	207	CA5_A	136	VSS	280	VSS
64	CA6_A	208	CA7_A	137	DM3_B_n	281	DQS3_B_c
65	VSS	209	VSS	138	VSS	282	DQS3_B_t
66	CA8_A	210	CA9_A	139	DQ28_B	283	VSS
67	CA10_A	211	CA11_A	140	VSS	284	DQ30_B
68	VSS	212	VSS	141	DQ29_B	285	VSS
69	CA12_A	213	RFU	142	VSS	286	DQ31_B
70	RFU	214	RFU	143	RFU	287	VSS
71	VSS	215	VSS	144	RFU	288	RFU
72	CK0_A_t	216	CK1_A_t				
73	CK0_A_c	217	CK1_A_c				

Block Diagram

8GB, 1Gx64 Module (1 Rank x16)

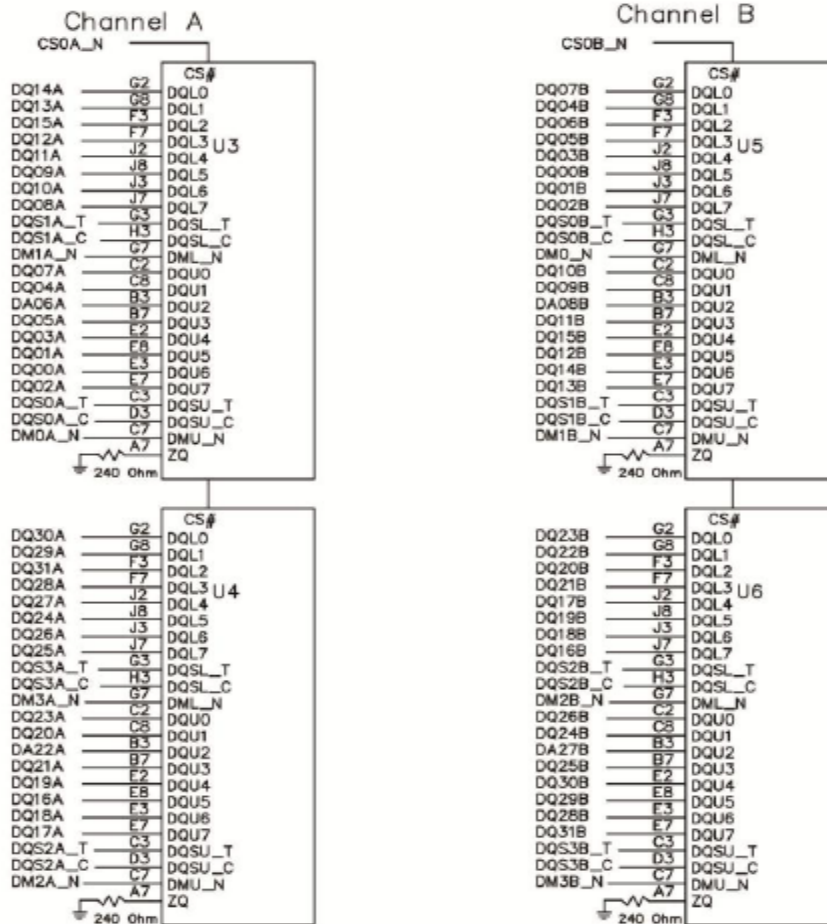

- CA_A[00:12] ——— DDRV SDRAM U3,U4
- CA_B[00:12] ——— DDRV SDRAM U5,U6
- CS0A_N ——— DDRV SDRAM U3,U4
- CS0B_N ——— DDRV SDRAM U5,U6
- CK0_A_C ——— DDRV SDRAM U3,U4
- CK0_A_T ——— DDRV SDRAM U3,U4
- CK0_B_C ——— DDRV SDRAM U5, U6
- CK0_B_T ——— DDRV SDRAM U5, U6

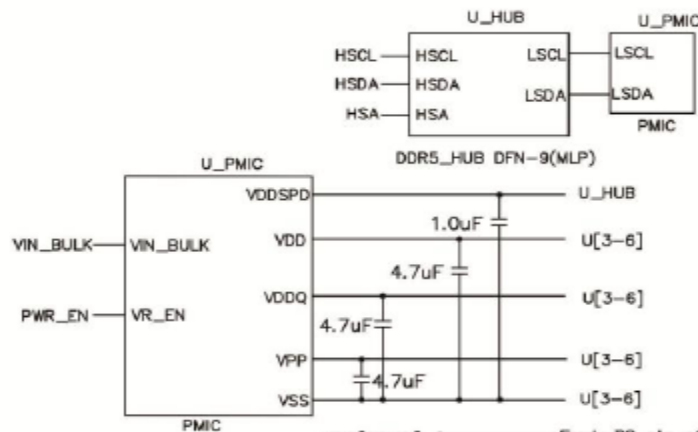

- Alert_n ——— DDRV SDRAM ——— 47 Ohm ——— VDDQ_1P1V
- RESET_n ——— DDRV SDRAM U[3-6]

- DQA[00:31] ——— Each DQ pin of DDRV SDRAM
- DQSA_C[00:03] ——— Each DQS_C pin of DDRV SDRAM
- DQSA_T[00:03] ——— Each DQS_T pin of DDRV SDRAM
- DMA_N[00:03] ——— Each DM_N pin of DDRV SDRAM
- DQB[00:31] ——— Each DQ pin of DDRV SDRAM
- DQSB_C[00:03] ——— Each DQS_C pin of DDRV SDRAM
- DQSB_T[00:03] ——— Each DQS_T pin of DDRV SDRAM
- DMB_N[00:03] ——— Each DM_N pin of DDRV SDRAM

This technical information is based on industry standard data and tests believed to be reliable. However, Advantech makes no warranties, either expressed or implied, as to its accuracy and assume no liability in connection with the use of this product. Advantech reserves the right to make changes in specifications at any time without prior notice.

Operating Temperature Condition

Parameter	Symbol	Rating	Unit	Note
Normal Operating Temperature	Toper normal	-20 to 85	°C	1,2,3,4
Extended Operating Temperature	Toper extended	85 to 95		1,2,3,4,5

Note:

- All operating temperature symbols, ranges, acronyms are referred from JESD402-1.
- Operating Temperature is the case surface temperature on the center/top side of the DRAM. For the measurement conditions, please refer to JESD51-2 standard.
- All DDR5 SDRAMs are required to operate in NT and XT temperature ranges.
- If TC exceeds 85°C, the DRAM must be refreshed externally at 2X refresh, which is a 1.95µs interval refresh rate.
- Operating Temperature for 3DS needs to be derated by the number of DRAM dies as: $[TOPER - (2.5^{\circ}C \times \log_2 N)]$, where N is the number of the stacked dies.

Absolute Maximum DC Ratings

Parameter	Symbol	Rating	Units	Notes
Voltage on VDD pin relative to Vss	VDD	- 0.3 ~ 1.4	V	1
Voltage on VDDQ pin relative to Vss	VDDQ	- 0.3 ~ 1.4	V	1
Voltage on VPP pin relative to Vss	VPP	- 0.3 ~ 2.1	V	
Voltage on any pin relative to Vss	VIN, VOUT	- 0.3 ~ 1.4	V	1
Storage temperature	TSTG	- 55 to +100	°C	1,2

Note:

- Stresses greater than those listed in this table may cause permanent damage to the device. This is a stress rating only and functional operation of the device at these or any other conditions above those indicated in the operational sections of this specification is not implied. Exposure to absolute maximum rating conditions for extended periods may affect reliability.
- Storage temperature is the case surface temperature on the center/top side of the device. For the measurement conditions, refer to JESD51-2 standard.

AC & DC Operating Conditions

DIMM Voltage Requirements

Symbol	Parameter	Voltage Rating (Volts)			Maximum Expected Current (Amps)	Power State
		Minimum	Typical	Maximum		
VIN_BULK	Host Supply Voltage	4.25	5.0	5.5	2.A	Operational
SWA,SWB	PMIC Output Supply Voltage	-	1.1	-	Note 9	Operational
SWA+SWB	PMIC Output Supply Voltage	-	1.1	-	Note 9	Operational
SWC	PMIC Output Supply Voltage	-	1.8	-	Note 9	Operational
1.8V LDO	PMIC Output Supply Voltage	-	1.8	-	0.025(maximum)	Operational
1.0V LDO	PMIC Output Supply Voltage	-	1.0	-	0.020(maximum)	Operational

NOTE:

- Input supplies referenced in this table are VIN_BULK and VIN.
- During first power-on, the input voltage supply must reach a minimum of 4.25V for the PMIC to detect a valid input supply.
- The ramp up rate is between 300mV and 4.0V.
- The ramp down rate is between 4.0V and 300mV.
- The area under the curve and above VIN_Bulk = TBD. The VIN_Bulk_AC spec must also be satisfied.

-
6. The minimum input current requirement is equal to the maximum output current on VOUT_1.8V and VOUT_1.0V LDO, plus the current required by the PMIC for its own use. The maximum input current is equal to the all VIN_Bulk input on the PMIC.
 7. VIN_Bulk = 5.0V measured at room temperature. All circuitry, including output regulators and LDOs are off. The VR_EN signal is static LOW or HIGH. The GSI_n signal is pulled HIGH. I2C or 13C basic interface access is not allowed, and the bus is pulled HIGH. The PID signal is pulled either HIGH or LOW
 8. VIN_Bulk = 5.0V measured at room temperature. All output regulators and LDOs are on the 0A output load. The VR_EN signal is static LOW or HIGH. The GSI_n signal is pulled HIGH. I2C or 13C basic interface access is not allowed, and the bus is pulled HIGH. The PID signal is pulled either HIGH or LOW.
 9. Maximum and Minimum Current ratings depend on PMIC (5100)

SERIAL PRESENCE DETECT SPECIFICATION

8192MB(1024Mx64Bit) Serial Presence Detect for DDR5 UDIMM (PC-44800) 5600 CL=46-45-45

BYTE	FUNCTION DESCRIBED	FUNCTION SUPPORTED	HEX VALUE
0	Number of Bytes in SPD Device	1024 bytes	30
1	SPD Revision for Base Configuration Parameters	Revision 1.0	10
2	Key Byte / Host Bus Command Protocol Type	DDR5 SDRAM	12
3	Key Byte / Module Type	UDIMM	02
4	First SDRAM Density and Package	Monolithic SDRAM, 16Gb	04
5	First SDRAM Addressing	16 rows, 10 columns	00
6	First SDRAM I/O Width	x16	40
7	First SDRAM Bank Groups & Banks Per Bank Group	4 bank groups, 4 banks per bank group	42
8	Second SDRAM Density and Package	Symmetrical	00
9	Second SDRAM Addressing	Symmetrical	00
10	Second SDRAM I/O Width	Symmetrical	00
11	Second SDRAM Bank Groups & Banks Per Bank Group	Symmetrical	00
12	SDRAM BL32 & Post Package Repair	One repair element per bank, Burst length 32 supported	90
13	SDRAM Duty Cycle Adjuster & Partial Array Self Refresh	Device supports DCA for 4-phase internal clocks	02
14	SDRAM Fault Handling	Bounded Fault not supported,	00
15	RESERVED	must be coded as 00	00
16	SDRAM Nominal Voltage, VDD	1.1V	00
17	SDRAM Nominal Voltage, VDDQ	1.1V	00
18	SDRAM Nominal Voltage, VPP	1.8V	00
19	SDRAM Timing	SDRAM uses standard core timings per JESD79-5	00
20	SDRAM Minimum Cycle Time (tCKAVGmin) LSB	0.357ns	65
21	SDRAM Minimum Cycle Time (tCKAVGmin) MSB	0.357ns	01
22	SDRAM Maximum Cycle Time (tCKAVGmax), LSB	1.010ns	F2
23	SDRAM Maximum Cycle Time (tCKAVGmax), MSB	1.010ns	03
24	CAS Latencies Supported, First Byte	50,46,42,40,36,32,30,28,26,22	7A
25	CAS Latencies Supported, Second Byte	50,46,42,40,36,32,30,28,26,22	AD
26	CAS Latencies Supported, Third Byte	50,46,42,40,36,32,30,28,26,22	00



Enabling an Intelligent Planet

288 Pin DDR5 1.1V 5600 UDIMM
8GB Based on 1Gx16
AQD-D5V8GN56-SCH

27	CAS Latencies Supported, Fourth Byte	50,46,42,40,36,32,30,28,26,22	00
28	CAS Latencies Supported, Fifth Byte	50,46,42,40,36,32,30,28,26,22	00
29	RESERVED	must be coded as 00	00
30	SDRAM Minimum CAS Latency Time (tAAMin), LSB	16.000	80
31	SDRAM Minimum CAS Latency Time (tAAMin), MSB	16.000	3E
32	SDRAM Minimum RAS to CAS Delay Time (tRCDmin), LSB	16.000	80
33	SDRAM Minimum RAS to CAS Delay Time (tRCDmin), MSB	16.000	3E
34	SDRAM Minimum Row Precharge Delay Time (tRPmin), LSB	16.000	80
35	SDRAM Minimum Row Precharge Delay Time (tRPmin), MSB	16.000	3E
36	SDRAM Minimum Active to Precharge Delay Time (tRASmin), LSB	32.000	00
37	SDRAM Minimum Active to Precharge Delay Time (tRASmin), MSB	32.000	7D
38	SDRAM Minimum Active to Active/Refresh Delay Time (tRCmin), LSB	48.000	80
39	SDRAM Minimum Active to Active/Refresh Delay Time (tRCmin), MSB	48.000	BB
40	SDRAM Minimum Write Recovery Time (tWRmin), LSB	30.000	30
41	SDRAM Minimum Write Recovery Time (tWRmin), MSB	30.000	75
42	SDRAM Minimum Refresh Recovery Delay Time (tRFC1min, tRFC1_slr min), LSB	295	27
43	SDRAM Minimum Refresh Recovery Delay Time (tRFC1min, tRFC1_slr min), MSB	295	01
44	SDRAM Minimum Refresh Recovery Delay Time (tRFC2min, tRFC2_slr min), LSB	160	A0
45	SDRAM Minimum Refresh Recovery Delay Time (tRFC2min, tRFC2_slr min), MSB	160	00
46	SDRAM Minimum Refresh Recovery Delay Time (tRFCsbmin, tRFCsb_slr min), LSB	130	82
47	SDRAM Minimum Refresh Recovery Delay Time (tRFCsbmin, tRFCsb_slr min), MSB	130	00
48	SDRAM Minimum Refresh Recovery Delay Time, 3DS Different Logical Rank(tRFC1_dlr min), LSB	must be coded as 00	00
49	SDRAM Minimum Refresh Recovery Delay Time, 3DS Different Logical Rank(tRFC1_dlr min), MSB	must be coded as 00	00
50	SDRAM Minimum Refresh Recovery Delay Time, 3DS Different Logical Rank(tRFC2_dlr min), LSB	must be coded as 00	00
51	SDRAM Minimum Refresh Recovery Delay Time, 3DS Different Logical Rank(tRFC2_dlr min), MSB	must be coded as 00	00
52	SDRAM Minimum Refresh Recovery Delay Time, 3DS Different Logical Rank(tRFCsb_dlr min), LSB	must be coded as 00	00
53	SDRAM Minimum Refresh Recovery Delay Time, 3DS Different Logical Rank(tRFCsb_dlr min), MSB	must be coded as 00	00
54	SDRAM Refresh Management, First Byte, First SDRAM	Refresh management not required	00
55	SDRAM Refresh Management, Second Byte, First SDRAM	Refresh management not required	00
56	SDRAM Refresh Management, First Byte, Second SDRAM	Refresh management not required	00

57	SDRAM Refresh Management, Second Byte, Second SDRAM	Refresh management not required	00
58	SDRAM Adaptive Refresh Management Level A, First Byte, First SDRAM	Adaptive refresh management not required	00
59	SDRAM Adaptive Refresh Management Level A, Second Byte, First SDRAM	Adaptive refresh management not required	00
60	SDRAM Adaptive Refresh Management Level A, First Byte, Second SDRAM	Adaptive refresh management not required	00
61	SDRAM Adaptive Refresh Management Level A, Second Byte, Second SDRAM	Adaptive refresh management not required	00
62	SDRAM Adaptive Refresh Management Level B, First Byte, First SDRAM	Adaptive refresh management not required	00
63	SDRAM Adaptive Refresh Management Level B, Second Byte, First SDRAM	Adaptive refresh management not required	00
64	SDRAM Adaptive Refresh Management Level B, First Byte, Second SDRAM	Adaptive refresh management not required	00
65	SDRAM Adaptive Refresh Management Level B, Second Byte, Second SDRAM	Adaptive refresh management not required	00
66	SDRAM Adaptive Refresh Management Level C, First Byte, First SDRAM	Adaptive refresh management not required	00
67	SDRAM Adaptive Refresh Management Level C, Second Byte, First SDRAM	Adaptive refresh management not required	00
68	SDRAM Adaptive Refresh Management Level C, First Byte, Second SDRAM	Adaptive refresh management not required	00
69	SDRAM Adaptive Refresh Management Level C, Second Byte, Second SDRAM	Adaptive refresh management not required	00
70	SDRAM Activate to Activate Command Delay for Same Bank Group (tRRD_L), Least Significant Byte	5000ps	88
71	SDRAM Activate to Activate Command Delay for Same Bank Group (tRRD_L), Most Significant Byte	5000ps	13
72	SDRAM Activate to Activate Command Delay for Same Bank Group (tRRD_L), Lower Clock Limit	8CK	08
73	SDRAM Read to Read Command Delay for Same Bank Group (tCCD_L), Least Significant Byte	5000ps	88
74	SDRAM Read to Read Command Delay for Same Bank Group (tCCD_L), Most Significant Byte	5000ps	13
75	SDRAM Read to Read Command Delay for Same Bank Group (tCCD_L), Lower Clock Limit	8CK	08
76	SDRAM Write to Write Command Delay for Same Bank Group (tCCD_L_WR), Least Significant Byte	20000ps	20
77	SDRAM Write to Write Command Delay for Same Bank Group (tCCD_L_WR), Most Significant Byte	20000ps	4E
78	SDRAM Write to Write Command Delay for Same Bank Group (tCCD_L_WR), Lower Clock Limit	32CK	20
79	SDRAM Write to Write Command Delay for Same Bank Group, Second Write not RMW (tCCD_L_WR2), Least Significant Byte	10000ps	10
80	SDRAM Write to Write Command Delay for Same Bank Group, Second Write not RMW (tCCD_L_WR2), Most Significant Byte	10000ps	27
81	SDRAM Write to Write Command Delay for Same Bank Group, Second Write not RMW (tCCD_L_WR2), Lower Clock Limit	16CK	10
82	SDRAM Four Activate Window (tFAW), Least Significant Byte	14285ps	CD
83	SDRAM Four Activate Window (tFAW), Most Significant Byte	14285ps	37
84	SDRAM Four Activate Window (tFAW), Lower Clock Limit	40CK	28
85	SDRAM Write to Read Command Delay for Same Bank Group (tCCD_L_WTR), Least Significant Byte	10000ps	10
86	SDRAM Write to Read Command Delay for Same Bank Group (tCCD_L_WTR), (tCCD_L_WTR), Most Significant Byte	10000ps	27

87	SDRAM Write to Read Command Delay for Same Bank Group (tCCD_L_WTR), Lower Clock Limit	16CK	10
88	SDRAM Write to Read Command Delay for Different Bank Group (tCCD_S_WTR), Least Significant Byte	2500ps	C4
89	SDRAM Write to Read Command Delay for Different Bank Group (tCCD_S_WTR), Most Significant Byte	2500ps	09
90	SDRAM Write to Read Command Delay for Different Bank Group, (tCCD_S_WTR), Lower Clock Limit	4CK	04
91	SDRAM Read to Precharge Command Delay (tRTP, tRTP_slr), Least Significant Byte	7500ps	4C
92	SDRAM Read to Precharge Command Delay (tRTP, tRTP_slr), Most Significant Byte	7500ps	1D
93	SDRAM Read to Precharge Command Delay (tRTP, tRTP_slr), Lower Clock Limit	12CK	0C
94-191	RESERVED	must be coded as 00	00
192	SPD Revision for Module Information	Revision 1.0	10
193	RESERVED		00
194	SPD Manufacturer ID Code, First Byte	installed	00
195	SPD Manufacturer ID Code, Second Byte	installed	00
196	SPD Device Type	installed	00
197	SPD Device Revision Number	installed	00
198	PMIC 0 Manufacturer ID Code, First Byte	installed	00
199	PMIC 0 Manufacturer ID Code, Second Byte	installed	00
200	PMIC 0 Device Type	installed	00
201	PMIC 0 Revision Number	installed	00
202	PMIC 1 Manufacturer ID Code, First Byte	Not installed	00
203	PMIC 1 Manufacturer ID Code, Second Byte	Not installed	00
204	PMIC 1 Device Type	Not installed	00
205	PMIC 1 Revision Number	Not installed	00
206	PMIC 2 Manufacturer ID Code, First Byte	Not installed	00
207	PMIC 2 Manufacturer ID Code, Second Byte	Not installed	00
208	PMIC 2 Device Type	Not installed	00
209	PMIC 2 Revision Number	Not installed	00
210	Thermal Sensors Manufacturer ID Code, First Byte	Not installed	00
211	Thermal Sensors Manufacturer ID Code, Second Byte	Not installed	00
212	Thermal Sensors Device Type	Not installed	00
213	Thermal Sensors Revision Number	Not installed	00

214-229	RESERVED		00
230	Module Nominal Height	31.25mm	11
231	Module Maximum Thickness	1.2mm	11
232	Reference Raw Card Used	C0	02
233	DIMM Attributes	XT, Heat spreader not installed, 1 row	81
234	Module Organization	Symmetrical, 1 PKG Rank	00
235	Memory Channel Bus Width	2 channels, 0 bits, 32 bits	22
236	RESERVED		00
237	RESERVED		00
238	RESERVED		00
239	RESERVED		00
240	Registering Clock Driver Manufacturer ID Code, First Byte	Not installed	00
241	Registering Clock Driver Manufacturer ID Code, Second Byte	Not installed	00
242	Register Device Type	Not installed	00
243	Register Revision Number	Not installed	00
244	RESERVED	Not installed	00
245	RESERVED	Not installed	00
246	Data Buffer Device Type	Not installed	00
247	Data Buffer Revision Number	Not installed	00
248	RCD-RW08 Clock Driver Enable	must be coded as 00	00
249	RCD-RW09 Output Address and Control Enable	must be coded as 00	00
250	RCD-RW0A QCK Driver Characteristics	must be coded as 00	00
251	RCD-RW0B	must be coded as 00	00
252	RCD-RW0C QxCA and QxCS_n Driver Characteristics	must be coded as 00	00
253	RCD-RW0D Data Buffer Interface Driver Characteristics	must be coded as 00	00
254	RCD-RW0E QCK, QCA and QCS Output Slew Rate	must be coded as 00	00
255	RCD-RW0F BCK, BCOM, and BCS Output Slew Rate	must be coded as 00	00
256	DB-RW86 DQS RTT Park Termination	must be coded as 00	00
257-509	RESERVED		00
510	CRC for SPD bytes 0-509	CRC cover 0-509 byte	54
511	CRC for SPD bytes 0-509	CRC cover 0-509 byte	FC



Enabling an Intelligent Planet

288 Pin DDR5 1.1V 5600 UDIMM
 8GB Based on 1Gx16
 AQD-D5V8GN56-SCH

512	Module Manufacturer ID Code, First Byte	Advantech	8A
513	Module Manufacturer ID Code, Second Byte	Advantech	C8
514	Module Manufacturing Location	Variable	00
515	Module Manufacturing Date	Variable	00
516	Module Manufacturing Date	Variable	00
517	Module Serial Number	Variable	00
518	Module Serial Number	Variable	00
519	Module Serial Number	Variable	00
520	Module Serial Number	Variable	00
521	Module Part Number	A	41
522	Module Part Number	Q	51
523	Module Part Number	D	44
524	Module Part Number	-	2D
525	Module Part Number	D	44
526	Module Part Number	5	35
527	Module Part Number	V	56
528	Module Part Number	8	38
529	Module Part Number	G	47
530	Module Part Number	N	4E
531	Module Part Number	5	35
532	Module Part Number	6	36
533	Module Part Number	-	2D
534	Module Part Number	S	53
535	Module Part Number	C	43
536	Module Part Number	H	48
537	Module Part Number	Blank Space	20
538	Module Part Number	Blank Space	20
539	Module Part Number	Blank Space	20
540	Module Part Number	Blank Space	20
541	Module Part Number	Blank Space	20
542	Module Part Number	Blank Space	20
543	Module Part Number	Blank Space	20
544	Module Part Number	Blank Space	20
545	Module Part Number	Blank Space	20
546	Module Part Number	Blank Space	20
547	Module Part Number	Blank Space	20
548	Module Part Number	Blank Space	20
549	Module Part Number	Blank Space	20
550	Module Part Number	Blank Space	20
551	Module Revision Code	Revision 0	00
552	DRAM Manufacturer's ID Code, First Byte	Variable	00
553	DRAM Manufacturer's ID Code, Second Byte	Variable	00
554	DRAM Stepping	Undefined	FF
555-637	Module Manufacturer's Specific Data		00



Enabling an Intelligent Planet

288 Pin DDR5 1.1V 5600 UDIMM
8GB Based on 1Gx16
AQD-D5V8GN56-SCH

638-1023	RESERVED		00
----------	----------	--	----