

ARK-3534B

Intel® Core™ 12th/13th/14th Gen i3/i5/i7/i9 LGA1700 Expansion Fanless Box PC

NEW



Features

- Support Intel® Core™ 12th/13th/14th Gen. i3/i5/i7/i9 processor
- Triple independent display: HDMI + HDMI + Optional Display
- DDR5 SO-DIMM memory support up to 64 GB
- 9-36V_{DC} wide range power input
- Up to 3sets 2.5" hard drive bays
- Support up to 4x GbE, 8x USB, 8x COM, 2x CANBus, 16bit DIO, TPM2.0
- SUSI API, WISE-DeviceOn, Trellix and Acronis bundled
- Support Windows 11 IoT Enterprise LTSC



WISE-DeviceOn SUSI API



Specifications

14 th Generation Processor	CPU	i9-14900	i7-14700	i5-14500	i5-14400	i3-14100				
	P-core Frequency	2.0-5.4GHz	2.1-5.3GHz	2.6-5.0GHz	2.5-4.7GHz	3.5-4.7GHz				
	L3 Cache	36MB	33MB	24MB	20MB	12MB				
	Cores	24	20	14	10	4				
	TDP	65W	65W	65W	65W	60W				
	Chipset BIOS	H610E (R680E support by project) AMI EFI 256Mbit								
13 th and 12 th Generation Processor	CPU	i9-13900E	i7-13700E	i5-13500E	i3-13100E	i9-12900E	i7-12700E	i5-12500E	i3-12100E	G6900E
	P-core Frequency	1.8-5.2GHz	1.9-5.1GHz	2.4-4.6GHz	2.3-4.4GHz	2.1-5.0GHz	1.6-4.8GHz	2.9-4.5GHz	3.2-4.2GHz	3.0GHz
	L3 Cache	36MB	30MB	24MB	12MB	30MB	25MB	18MB	12MB	4MB
	Cores	24	16	14	4	16	12	6	4	2
	TDP	65W	65W	65W	60W	65W	65W	65W	60W	46W
	Chipset BIOS	H610E (R680E support by project) AMI EFI 256Mbit								
Memory	Technology	DDR5 4800 MHz								
	Max. Capacity	64 GB								
	Socket	2 x 262-pin SO-DIMM								
Graphics	Chipset	Intel® UHD Graphics 770								
	Graphic Engine	DirectX 12, OpenGL 4.5 HW Encode: H.265/HEVC, H.264/MPEG-4 AVC, MPEG-2, JPEG/MJPEG and VP8. HW Decode: H.265/HEVC, H.264/MPEG-4 AVC, MPEG-2, VC-1/WMV9, JPEG/MJPEG, VP8 and VP9								
	HDMI	2 HDMI port, HDMI 2.0 for HD video playback, 4096x2160@60Hz								
	Optional 3rd Display module	DVI-D / DP / HDMI Display Port								
	Triple Display	HDMI+HDMI + 3rd display module								
Ethernet	LAN1	10/100/1000 Mbps Intel I219-LM GbE, support Wake On LAN								
	LAN2	10/100/1000/2500 Mbps Intel i225-V GbE, support Wake On LAN (LAN3/4 support by project with PCH R680E)								
Audio	Interface	Realtek ALC888S, High Definition Audio, Line-out/Mic-in (switch)								
Others	Watch dog Timer	255-level timer interval, setup by software								
	TPM	TPM 2.0 (by optional AMO-I029)								
I/O Interface	Serial Port	4 x RS-232/422/485 port with auto flow control, 2 x RS-232 (additional COM7/8 2 x RS-232 by optional cable)								
	USB	4 x USB 3.2 (2 x Gen2, 2 x Gen1), 4 x USB 2.0 1 x Internal USB2.0 (Optional)								
	DIO	16bit DIO (by optional cable)								
Expansions	CANBus	2 ports by optional cable								
	M.2	1 x M.2 2230 E key and 1 x M.2 2280 B key with SIM holder #1								
	Add-on Card Slot	1 Slot PCIe4 + 1 Slot PCIe16 (If card power power consumption over 30W for add-on cards, please bundled with AMO-3508 kit for power and thermal solutions)								
	Maximum card size	110mm (H) x 180mm (L)								
Storage	HDD	2 x 2.5" SATAIII 15mm height HDD bay(Up to 3 x 2.5" SATAIII HDD bays)								
	NVME	1 x PCIe2 (Share with M.2 2280 B key)								

Specifications (Cont.)

Software Support	Microsoft Windows	Windows 10/11
	Linux	Ubuntu
Power Requirements	Power Type	AT/ATX
	Power Input Voltage	9-36V
	Power Adapter	AC to DC, 230W (Optional)
Power Consumption (CPU/Memory Only)	Typical	56.1W
	Max.	92.4W
Mechanical	Construction	Aluminum housing
	Mounting	Desk mounting
	Dimensions (W x H x D)	156 x 204 x 230 mm
	Weight	5.705Kg
Environment	Operating Temperature	Up to 65W processor with extended temp peripherals: -20 ~ 60° C with 0.7m/s air flow with HDD: 0 ~ 40° C with 0.7m/s air flow
	Storage Temperature	-40 ~ 85° C
	Relative Humidity	95% @ 40° C (non-condensing)
	Vibration During Operation	With SSD: 3 Grms, IEC 60068-2-64, random, 5 ~ 500 Hz, 1 hr/axis.
	Shock During Operation	With SSD: 30 G, IEC 60068-2-27, half sine, 11 ms duration
	EMC	CE/FCC Class B, CCC, BSMI
Safety	CB, UL, CCC, BSMI	

#1 SIM holder and M.2 slot are hardware interfaces for wireless communication integration only. System level RF certification is not available.

Dimensions

Unit: mm

Wallmount

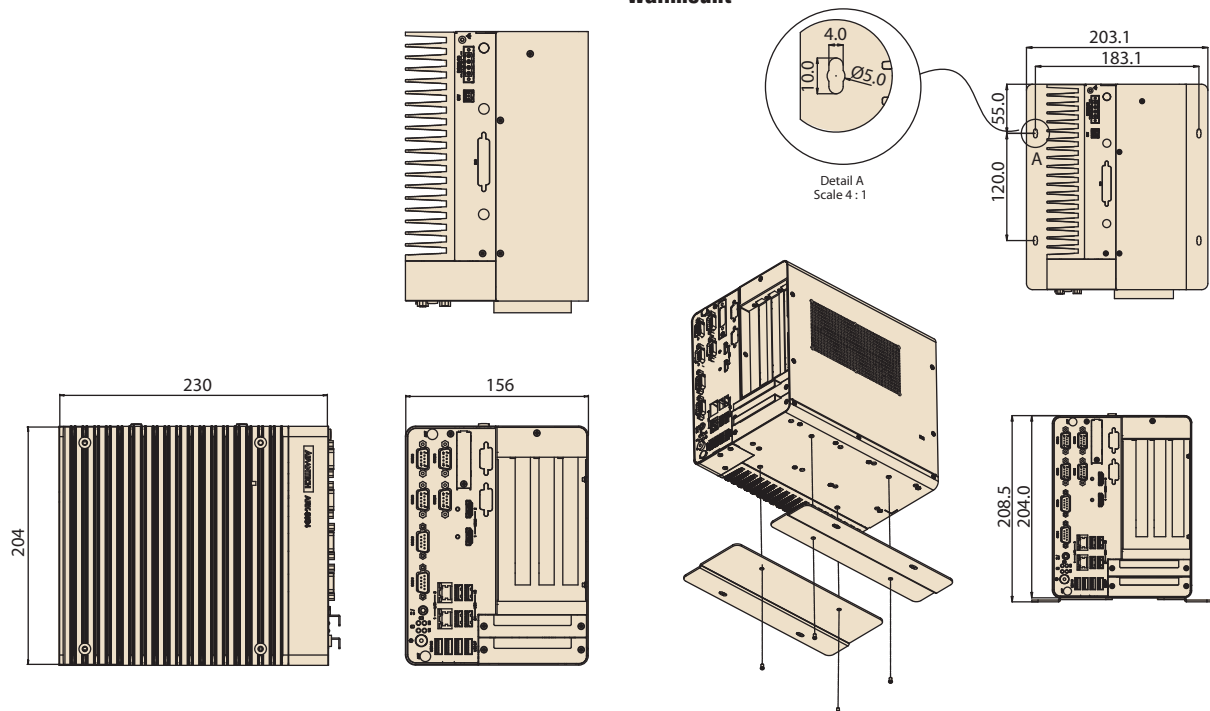

External I/O Mechanical Layout/Drawing

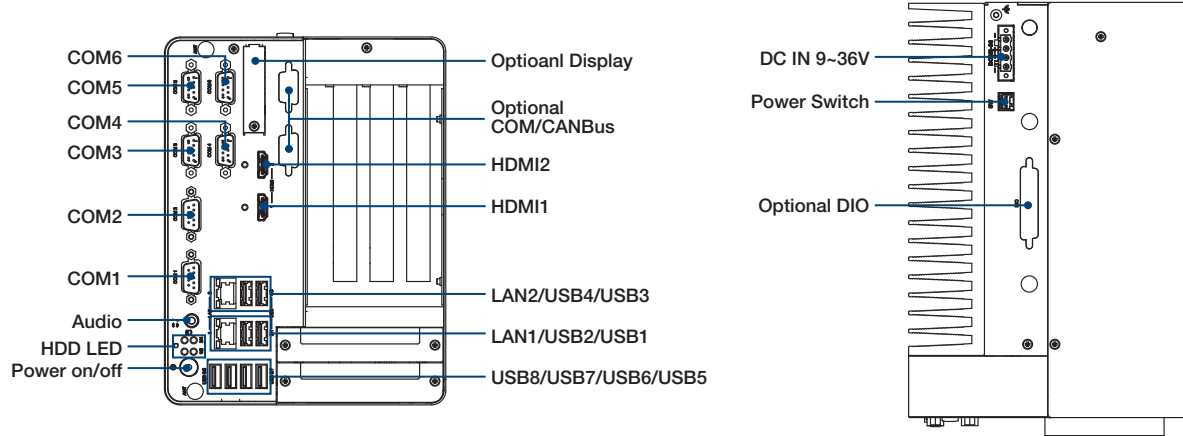

Ordering Information

Part No.	CPU	DDR5	Gbe	HDMI	Option 3rd display module	RS-232	RS-232/422/485	USB	M.2 B key	SIM	M.2 E Key	DC Input	Expansion	Made in
ARK-3534B-00A1	LGA1700 Socket Type	Up to 64GB	2	2	1	Up to 4	4	8	1	1	1	9-36V	PCIex4 + PCIex16	China
ARK-3534B-00A1U	LGA1700 Socket Type	Up to 64GB	2	2	1	Up to 4	4	8	1	1	1	9-36V	PCIex4 + PCIex16	Taiwan

Note: CPU/Memory/Storage and operating system bundled by request.

Packing List

Part Number	Description
-	ARK-3534B Unit
-	User Manual (Simplified Chinese)
-	China RoHS
-	Desk mounting kit
36WSWPDOBUND11	WISE-DeviceOn
36WSWPDOB0211	McAfee Application Control Lite/Acronis Backup 11.7 for Windows PC

Embedded OS

Part Number	Description
20706WX1HS0128	WIN10 IoT LTSC 21H2 64bit for i7/i9
20706WX1VS0128	WIN10 IoT LTSC 21H2 64bit for i3/i5
20706U22DS0031	UbuntuD ARK-3534 64b 22.04 ENU
20706WLH1S0017	WIN11 IoT LTSC 2024 for i7/i9
20706WLV1S0017	WIN11 IoT LTSC 2024 for i3/i5

ARK-3534B Optional Expansion Kit for add-on Cards

Part Number	Description
AMO-3508	ARK-3534B/C fan kit
AMO-3508A	ARK-3534B/C fan kit for Nvidia A2 Tensor
XARK-DPS-150AB-15	Additional Power for add-on cards over 30Watts

*Please add this kit once the add-on card power consumption over than 30Watts

ARK-3534B Default SKU Option Items

Optional Item for Default SKU

Part Number	Description
96PSA-A230W24P4-3	AC to DC adapter, DC 24V 230W, -20 ~ 60 °C
1702002600	Power cable 3-pin 183cm, USA type
1702002605	Power cable 3-pin 183cm, EU type
1702031801	Power cable 3-pin 183cm, UK type
1700000237	Power cable, 3-Pin 183cm, PSE type
1700031864-01	16bits DIO Cable(CN : GPIO01)
1700026760-21	Internal USB Cable(CN : USB9)
1700029565-11	COM7/8 cable (Screws 193A200001*2)
1700030518-01	1 Port CANBus (Screws 193A200001*2)

ARK-3534B Optional HDD expansion Kit

Part Number	Description
1700033651-01	SATA cable for 3rd HDD/SSD (Screws 19310305C0*4pcs)

Optional Display Module

Part Number	Description
AMO-D001E	DVI-D module
AMO-D002E	DP module
AMO-D003E	HDMI module

Optional TPM Module

Part Number	Description
AMO-I029	TPM 2.0 Infineon SLB9670V2.0