

# ASMB-622

**Dual LGA 4189 Intel® Xeon® Scalable Proprietary Server Board with 16 DDR4, 4 PCIe x16, 3 PCIe x8, 1 PCIe x4, 5 SATA3, 4 USB3.0, IPMI**

**NEW**

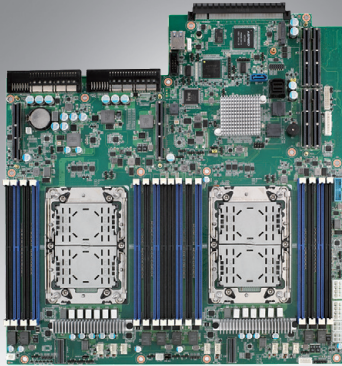

## Features

- Proprietary server board with dual Xeon® Scalable processors
- DDR4 3200MHz RDIMM up to 1TB, support Intel Optane Persistent Memory
- 1 SFF-8643 connector support 4 ports SATA drive, 1 M.2 2280 on board
- 1 SlimSAS connector support 2 ports NVMe drive in option
- Four PCIe x16 slots (Gen4) supporting 2 double deck cards with active FAN
- Four PCIe X8 slots support 3 PCIeX8 and 1 PCIeX4 signals
- Quad LAN with Intel I350
- Flexible IO board design

CE FCC

## Specifications

Form Factor		Proprietary 326 x 343 mm (12.83" x 13.5")	
Processor System	Socket	Intel LGA 4189	
	CPU type	3rd Gen Intel Xeon Scalable processors (CPU cooler should be purchased separately and TDP up to 165W)	
Core Logic	Chipset	Intel C621A chipset	
Memory	Total slots	16 (1 DIMM per channel)	
	Capacity	Maximum 1TB ECC RDIMM	
	Memory type	DDR4 2666/2933/3200MHz RDIMM	
	Memory size	8GB, 16GB, 32GB, 64GB	
Expansion Slots	Total PCIe slots	8	
	Lower Right Riser Card Cage-Slot 1	FH/FL PCIe x16 slot (x16 link), signal from CPU0	
	Lower Right Riser Card Cage-Slot 2	FH/FL PCIe x16 slot (x16 link), signal from CPU1	
	Upper Right Riser Card Cage-Slot 3	FH/FL PCIe x16 slot (x16 link), signal from CPU0	
	Upper Right Riser Card Cage-Slot 4	FH/FL PCIe x16 slot (x16 link), signal from CPU1	
	Middle Riser Card Cage-Slot 5	FH/HL PCIe x8 slot (x8 link), signal from CPU0	
	Middle Riser Card Cage-Slot 6	FH/HL PCIe x8 slot (x4 link), signal from PCH	
	Left Riser Card Cage-Slot 7	FH/HL PCIe x8 slot (x8 link), signal from CPU1	
Left Riser Card Cage-Slot 8	FH/HL PCIe x8 slot (x8 link), signal from CPU1		
Graphics	VGA	Aspeed AST 2500	
Storage	SATA controller	Intel C621A: 4 x SATA3 (6Gb/s) support software RAID 0,1,5,10	
	SAS controller	-	
	NVMe controller CPU0	2 x NVMe support VROC (optional)	
Networking	GbE	4 x Intel I350	
Onboard I/O Connector	PSU connector	Power card edge connector, 2 x 8 pin and 2 x 4 pin power connector	
	USB connector	2 x USB3.0 ports (type A) + 2 x USB3.0 ports (onboard header)	
	Fan header	9 (2 for CPU fan + 6 for system 8cm fan + 1 for system 6cm fan)	
	M.2	1 x M.2 2280 B+M key (SATA/PCIe)	
	SMBus	1	
	Chassis intruder	1	
	Front LAN LED	1	
	Audio Header	-	
	PS/2 Keyboard/Mouse header	-	
	Serial port header	1	
Rear I/O Connector	External serial port	1	
	External USB port	2 (USB3.0)	
	VGA port	1	
	RJ-45	5 (1 port dedicated BMC)	
	PS/2 Keyboard/Mouse	-	
	Infiniband	-	
Management Solution	Software	-	
	Out of band remote management	Yes	
Monitoring	CPU temperature	Yes	
	System Monitoring	Yes	
Watchdog Timer	Output	System reset	
	Interval	Programmable 1 ~ 255 sec/min	
Environment		Operating	Non-operating
	Temperature	0 ~ 40 °C, depends on CPU speed and cooler solution	-40 ~ 85 °C
	Humidity	10% ~ 95%	10% ~ 95% (Non condensing)
Physical Characteristics	Dimension (L x H)	326 x 343 mm (12.83" x 13.5")	

### Block Diagram

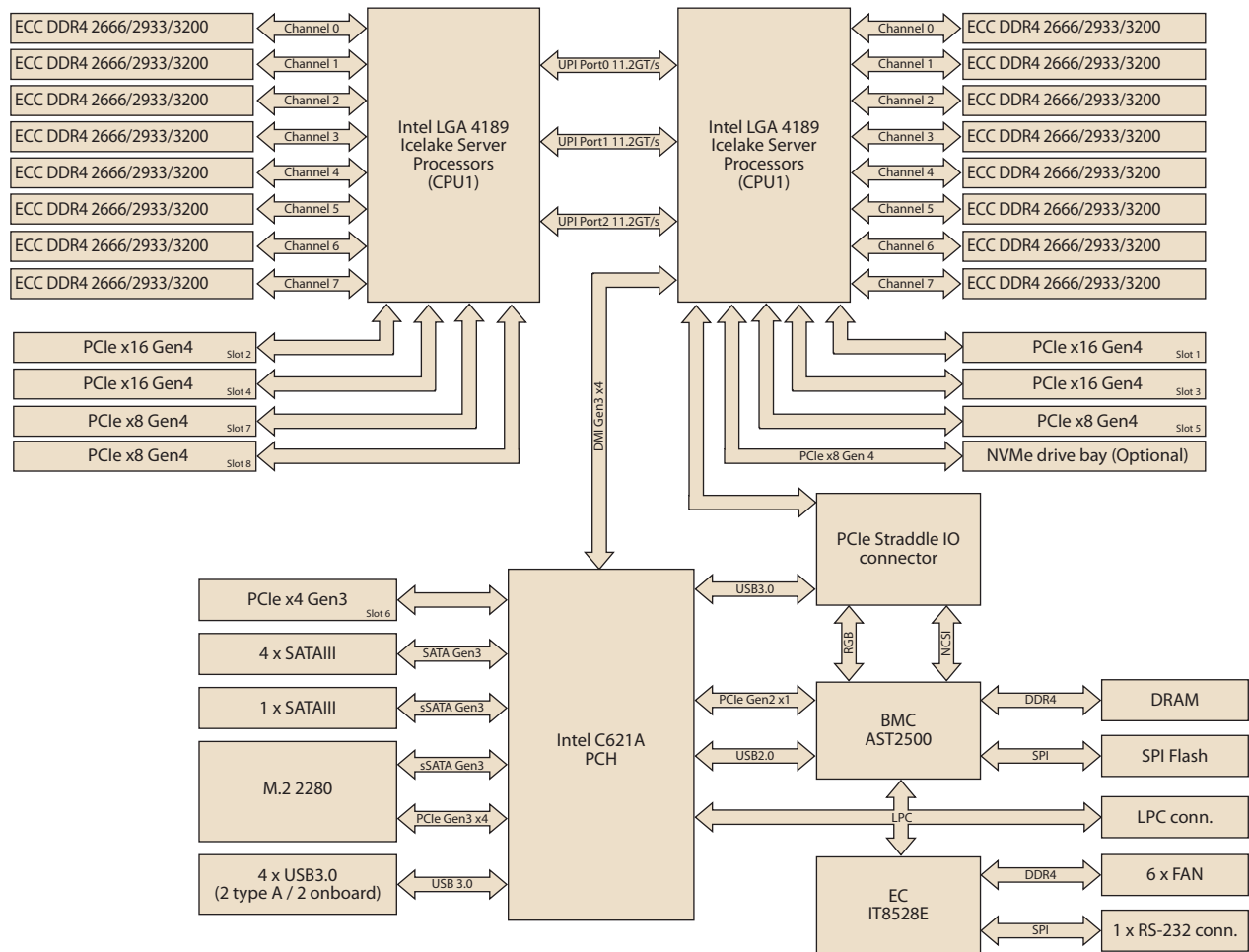

### Ordering Information

Part Number	Chipset	Memory	GbE/10GbE LAN	IPMI	Graphics
ASMB-622-00A1	C621A	16 x DDR4 RDIMM	4/-	Yes	AST 2500

### Packing List

Part Number	Description	Quantity
2042B62200	Startup manual	x 1
1651003476-01	LGA4189 CPU carrier	x 2
1700032421-01	SFF-8643 to 4 port SATA cable	x 1

### Optional Accessories

Part Number	Description
PCA-TPM-00B1E	TPM 2.0 module
1970004902T000	LGA4189 narrow CPU cooler for 2U/4U chassis
98926240000	2-port NVMe drive kit

### I/O View

