

IDS-3215

15" XGA Industrial Panel Mount Monitor

NEW



Features

- 15" XGA LCD panel with LED backlight for 20% power saving and environmental protection
- -20° ~ +60° C wide range operating temperature
- 5-wire resistive and P-cap touchscreen solution or tempered smudge resistant protected glass
- Combo touch interface: RS-232 and USB
- Dual signal interface with VGA & DVI
- Standard integrated frame
- Versatile mounting methods for rear mounting and VESA mounting
- Anti-Reflective treatment (optional)
- Ultra high brightness solution of 1200 cd/m² for outdoor applications (optional)

Introduction

The Advantech IDS-3215 Embedded Industrial Panel Mount Monitor series offers flexible options for LCD, touchscreen, signal interface and chassis mounting. The series with standard integrated frame design, supports rear and VESA mounting which brings the benefits of easy installation and provides flexibility for different applications.

Specifications

	Model	IDS-3215	IDS-3215P	IDS-3215E
Display	Size	15" LED panel	15" LED panel	15" LED panel
	Resolution	1024 x 768 (XGA)	1024 x 768 (XGA)	1024 x 768 (XGA)
	Viewing Angle	80°/80° (H), 70°/70° (V)	88°/88° (H), 88°/88° (V)	80°/80° (H), 70°/70° (V)
	Brightness	400 (cd/m ²)	500 (cd/m ²)	300 (cd/m ²)
	Color Support	16.2M / 262K colors	16.7M/262K	16.2M / 262K colors
	Contrast Ratio	700:1	2500:1	2000:1
	Response Time	25 [msec]	16 [msec]	16 [msec]
	Backlight Life (hrs)	50,000 hrs	50,000 hrs	50,000 hrs
Touchscreen	Touchscreen Type	5-Wire Resistive Touchscreen	Projected Capacitive Touchscreen	
	Surface Hardness	3H	Mohs 5	
	Durability	10 million touches	-	
	Transparency	80%+/-3%	89±3%	
Environment	Operating Temperature	-20 ~ 60° C (-4 ~ 140° F)	-20 ~ 60° C (-4 ~ 140° F)	0~ 45° C (32 ~ 113° F)
	Storage Temperature	-30 ~ 70° C (-22 ~ 158° F)	-30 ~ 70° C (-22 ~ 158° F)	-20 ~ 60° C (-4 ~ 140° F)
	Humidity	5 ~ 95% @ 40° C, non-condensing		
	Vibration	5-500 Hz, 0.026G ² /Hz, 2.16Grms, X, Y, Z 1 hour per axis		
System	I/O	VGA x 1; DVI-D x 1; 12 V _{DC} Jack x 1; USB x1; RS-232 x 1 (USB & RS-232 are reserved for the connection to enable touch usage only)		VGA x 1; 12 V _{DC} Jack x 1; USB x1; RS-232 x 1 (USB & RS-232 are reserved for the connection to enable touch usage only)
	OSD	Keys: menu, up, down, auto adjust, monitor power on/off Menu Functions: brightness, contrast, screen settings, color temp, language OSD settings, VGA/ DVI , recall , auto adjust		Keys: menu, up, down, auto adjust, monitor power on/off Menu Functions: brightness, contrast, color adjust, color temp, auto color, and language
	Power	60 W power adapter, with AC 100 ~ 240 V input and DC +12 V @ 5 A output		
	EMC Compliance	CE/FCC/CCC		

Dimensions

Unit: mm

IDS-3215 series

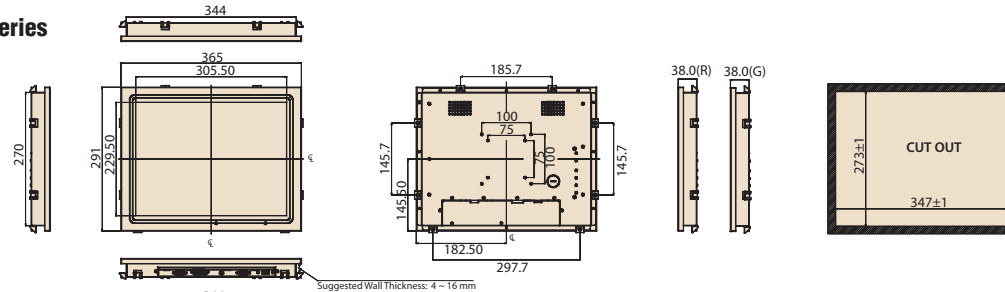

IDS-3215P

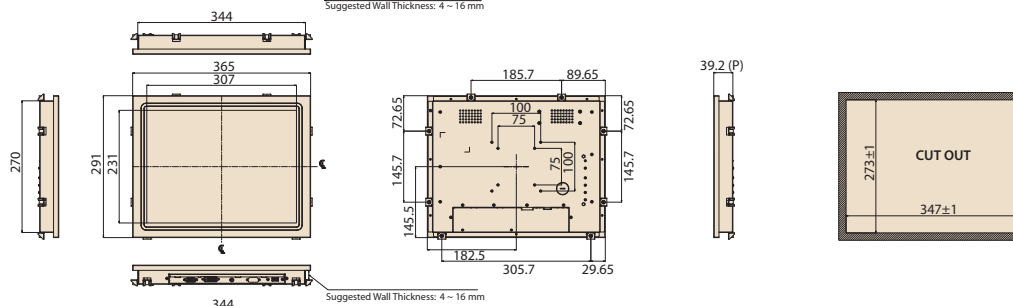

IDS-3215E series

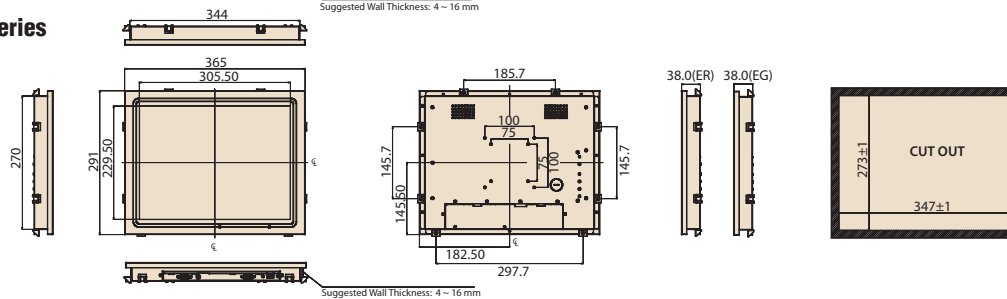

Packing List

Part Number	Description
1700002215	1 x M cable USB-A(M)/USB-A(M) 180 cm
1700021332-11	1 x VGA cable 15P(M) 180 cm
1962055040	8 x clamper
1935042520	8 x clamper screw M4_25L
1992610005	1 x cable clamp
1933030500	1 x cable clamp screw
1992602010	1 x cable tie

* USB Cable is only included in IDS-3215R/P and IDS-3215ER series.
Note: Package contents are subject to change without prior notice

Optional Items

Part Number	Description
1702002600	Power cord 3P (USA)
1700000596	Power cord 3P (China)
1700018705	Power cord 3P (EU)
96PSA-A60W12R1-1	Adapter AC100-240V 60W +12V/5A
1700000243-11	M cable DVI 19P(M)/DVI 19P(M) 191cm
1700091800	Cable 9P/9P 1.8M M/F (Touchscreen RS-232 cable)

Ordering Information

Model Name	Description
IDS-3215G-40XGA1E	15" XGA 400 cd/m ² LED Panel Mount Monitor
IDS-3215R-40XGA1E	15" XGA 400 cd/m ² LED Panel Mount Touch Monitor
IDS-3215EG-25XGA1E	15" XGA 300 cd/m ² LED Panel Mount Monitor
IDS-3215ER-25XGA1E	15" XGA 300 cd/m ² LED Panel Mount Touch Monitor
IDS-3215P-50XGA1	15" XGA 500 cd/m ² LED Panel Mount Touch Monitor

I/O view

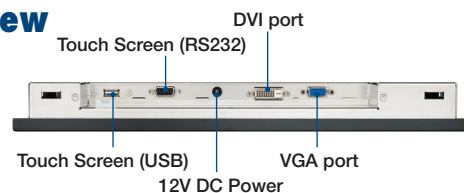

Rear View

