

# PAX-355

## 55" UHD Surgical Display

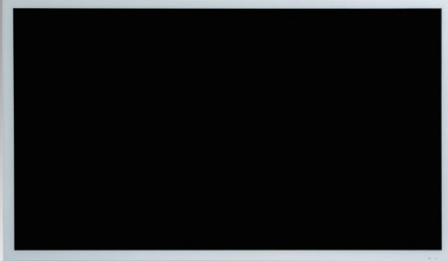

### Features

- High Brightness and High Contrast Ratio
- UHD Resolution (3840 x 2160)
- HDMI1.4, Support Up to 3840 x 2160 @ 30 Hz
- HDMI2.0, Support Up to 3840 x 2160 @ 60 Hz
- Display Port 1.2, Support Up to 4K x 2K, 3840 x 2160 @ 60 Hz
- Multi-Picture display: Normal , PiP, PBP, 4P
- 14 Bit LUT (Look Up Table) processing
- DICOM Standard GSDF included (DICOM Part 14 Compliant)
- DICOM Clear , Blue Mode support
- Variable Gamma and DICOM (Color Temp) mode
- Built in Touch Screen (Option)
- True Flat Design



### Specifications

Item	PAX-355-C8B-NAS PAX-355-C8B-NAR		PAX-355-C8E-NAS, PAX-355-C8E-NAR, PAX-355-C8A-NBS, PAX-355-C8A-NBR, PAX-355-C8E-NBS, PAX-355-C8E-NBR, PAX-355-C8D-NAS, PAX-355-C8D-NAR	
Display	Screen Size(Active Area)	54.64 (1209.6(H) x 680.4(V) [mm])		
	Aspect ratio	16 : 9		
	Number of Pixels	3840(H) x 2160(V)		
	Pixel Pitch	0.315(H) mm x 0.315(V) [mm]		
	Displayable Colors	1.07 Billion (10-bit)		
	Brightness (Typical)	500 cd/m <sup>2</sup>		
	Contrast Ratio (Typical)	1,100:1		
	Pannel Type	IPS		
	Response Time (Typical)	8ms (Gray to Gray)		
	Viewing Angle(H/V)	178/178		
Touch Screen (Option)	Optional 10-point PCAP			
In / Out Terminals	DC Power Output	DC Jack x 1	-	DC5V or DC12V
	RS-232C	D-Sub Jack x 1	-	Service Port
	DVI Input	DVI Jack x 1 (Type D)	-	Digital RGB : TMDS MAX : 3840 x 2160@30Hz
	DVI Output	DVI Jack x 1 (Type D)	-	Digital RGB : TMDS MAX : 3840 x 2160@30Hz
	HDMI 2.0 Input	HDMI Jack x 1 (Type A)	-	Digital RGB : TMDS MAX : 3840 x 2160@60Hz
	HDMI 2.0 Output	HDMI Jack x 1 (Type A)	-	Digital RGB: TMDS MAX: 3840 x 2160@60Hz
	HDMI 1.4 Input	HDMI Jack x 4 (Type A)	Digital RGB: TMDS MAX: 3840 x 2160@30Hz	-
	DP 1.2 Input	DP Jack x 1	-	DisplayPort 1.2 MAX: 3840 x 2160@60Hz
	DP 1.2 Output	DP Jack x 1	-	DP(1.2) MST or Daisy chain x1
	RGB Input	D-Sub Jack x 1	Analog RGB: 0.7[p-p] (75Ω), MAX : 1920 x 1080 / 60 Hz	-
	Audio Input	Ear Jack x 1	Audio Input Stereo L/R	-
	Headphone Output	Ear Jack x 1	Audio Output Stereo L/R	-
	USB Up	USB-B Jack x 1	USB 3.0	USB 2.0 (For Touch Screen)
	USB Down	USB-A Jack x 2	USB 3.0	-
Optional In / Out	SDI 12G In / Out	BNC Jack x 1	PAX-355-C8E-NBS, PAX-355-C8E-NBR, PAX-355-C8E-NAS, PAX-355-C8E-NAR	
	SDI Quad 3G In / Out	BNC Jack x 4	PAX-355-C8D-NAS, PAX-355-C8D-NAR	
Power	Power Supply	AC 100-240V, 50-60Hz, 6-3A		
	Power Consumption (Typical)	158.0 W max		
Physical Characteristics	Dimensions (Without Stand) [W mm x H mm x D mm]	1279.0 x 747.4 x 75.0 [mm]		PAX-355-C8*-NB*: 1279.0 x 747.4 x 102.5 [mm]
	Weight (Without Stand)	55.8 Kg max		
	VESA Mount	600mm * 400mm		
Environment Condition	Temperature	Operational	0 ~ 40 °C	
		Storage	-20 ~ 60 °C	
	Humidity	Operational	Ta = 40 °C, 90% RH non-condensed	
		Storage	5 ~ 90%	
Pressure	Operational	500 hPa to 1013 hPa		
	Storage	500 hPa to 1013 hPa		
Certifications	CE MDR (EN60601-1; EN60601-1-2), FCC, RoHS II			

\* The specifications are subject to change without notice

\* PAX-355 also provides open frame solution. Please contact sales for detailed information,

## Dimensions

Unit: mm

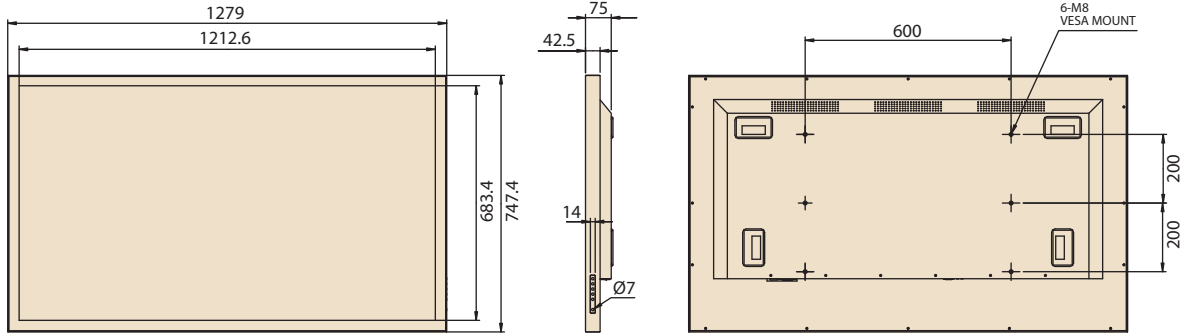

## Rear / Function Keys

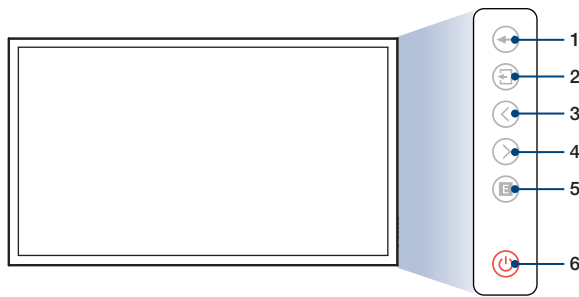

- |                    |                             |
|--------------------|-----------------------------|
| 1. MENU /Enter Key | 4. RIGHT Key                |
| 2. EXIT/INPUT Key  | 5. EXPERT Key (no function) |
| 3. LEFT Key        | 6. POWER Button             |

## I/O Ports

(PAX-355-C8B-NAR, PAX-355-C8B-NAS)

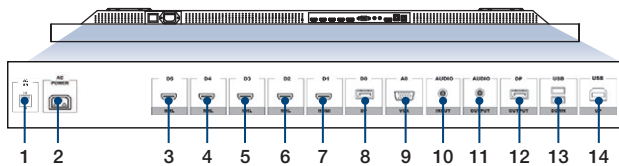

No.	I/O ports
1	AC Switch : Main Power On/Off
2	AC Power Input : AC Power Cord
3-6	HDMI 1.4 Input
7	HDMI 2.0 Input
8	DP 1.2 Input
9	RGB Input
10	Audio Input
11	Audio Output
12	DP Output (Option)
13	USB 3.0 Downstream port x2
14	USB 3.0 Upstream port

(PAX-355-C8A-NBS, PAX-355-C8A-NBR)

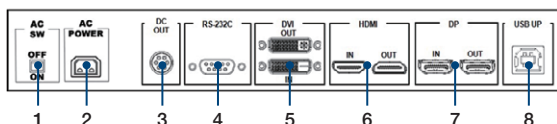

(PAX-355-C8E-NBS, PAX-355-C8E-NBR)

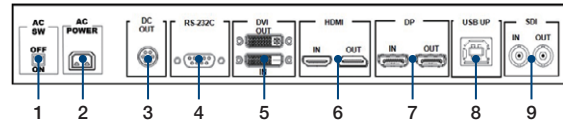

(PAX-355-C8E-NAR, PAX-355-C8E-NAS)

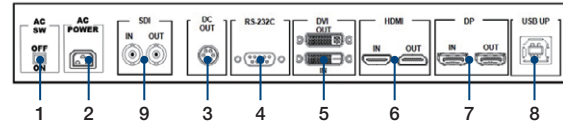

(PAX-355-C8D-NAS, PAX-355-C8D-NAR)

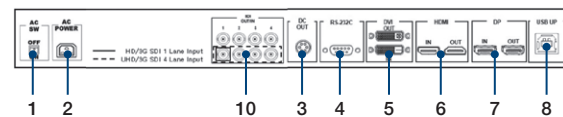

No.	I/O ports
1	AC Switch : Main Power On/Off
2	AC Power Input : AC Power Cord
3	DC Power Output : +5V/+12V Power Connector
4	RS-232C
5	DVI Input(Down)/DVI Output(Up)
6	HDMI Input(Left)/HDMI Output(Right)
7	DP Input(Left)/DP Output(Right)
8	USB UP
9	SDI Input(Left)/SDI Output(Right) (Option)
10	SDI Input(Down)/SDI Output(Up) (Option)

## Ordering Information

Part Number	Touch	Cover Glass
PAX-355-C8B-NAR	PCAP w/AR	-
PAX-355-C8B-NAS	-	Glass w/AR
PAX-355-C8E-NAR	PCAP w/AR	-
PAX-355-C8E-NAS	-	Glass w/AR
PAX-355-C8A-NBS	-	Glass w/AR
PAX-355-C8A-NBR	PCAP w/AR	-
PAX-355-C8E-NBS	-	Glass w/AR
PAX-355-C8E-NBR	PCAP w/AR	-
PAX-355-C8D-NAS	-	Glass w/AR
PAX-355-C8D-NAR	PCAP w/AR	-

## Accessories

Accessories	Specifications
Standard	Owner's instruction, Power Cord
Option	DP Cable, HDMI Cable, DVI Cable, SDI BNC Cable