

SKY-MXM-A4500

MXM 3.1 Type B+ NVIDIA® Quadro® Embedded A4500 with DP 1.4a

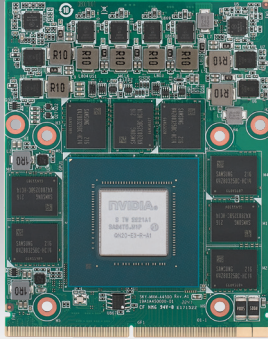

CE FCC

Features

- NVIDIA® Quadro® A4500 with MXM 3.1 TYPE B+ form factor(82 x 105 mm)
- Up to 5888 CUDA cores , 46 RT cores and 184 Tensor cores, 17.66 TFLOPS
- GDDR6 16GB memory, 256-bit, bandwidth 512 GB/s
- Up to 4 x DisplayPort 1.4a outputs
- Long life cycle, supports 5 years availability

Specifications

Processor System	GPU	Quadro® A4500	
	Graphic Architecture	NVIDIA® Ampere™ GA104-955	
	CUDA Parallel-Processing Cores	5,888 CUDA® cores	
	GPU Base/Boost Clock	930 MHz / 1500 MHz	
	RT Cores	46	
	Tensor Cores	184	
	FP32 Performance	17.66 TFLOPS	
Memory	Technology	GDDR6 16GB memory	
	Interface Width	256-bit	
	Bandwidth	512 GB/s	
Graphics	DP	4 x DisplayPort 1.4a, 4K at 120Hz or 8K at 60Hz (Requires DSC) Support HDMI 2.0 via DP dual-mode, 4K at 60Hz	
Bus	PCI express 3.0	MXM 3.1, Type B+ PCI Express Gen3 x16 supports	
Power Consumption	Max Power Consumption	115W	
Environment	Temperature	Operating	Non-Operating
		0 ~ 55 °C (dependent on CPU and cooler solution)	-40 ~ 85 °C
	Humidity	40 °C @ 85% relative humidity (non-condensing)	60 °C @ 95% relative humidity (non-condensing)
Physical	Dimensions	82 (W) x 105 (D) mm	
	Form Factor	MXM 3.1 Type B+(Proprietary thermal solution required)	
OS	Microsoft	Windows 10/11, 64-bit	
	Linux	Linux Drivers, 64-bit	

Dimensions

Unit: mm

SKY-MXM-A4500

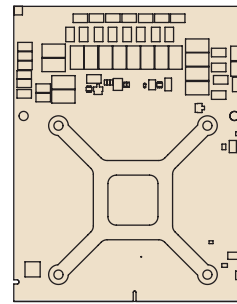
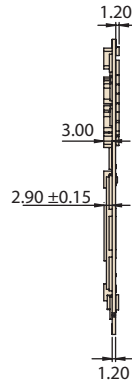
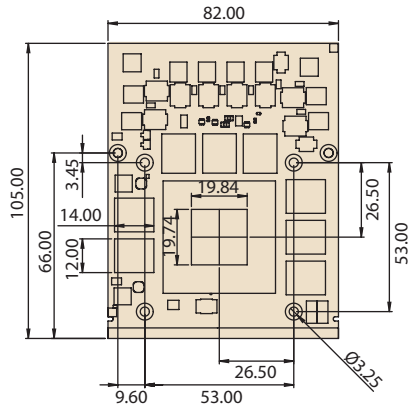

SKY-MXM-A4500 with Fan Cooler (Option)

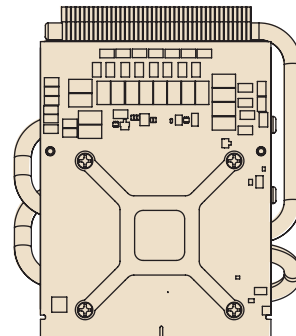
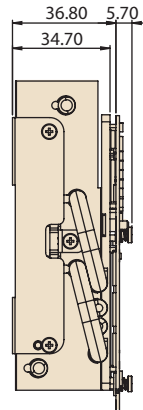
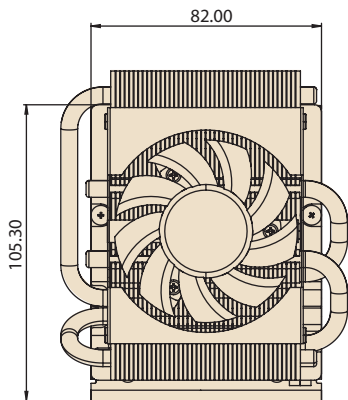

SKY-MXM-A4500 with Heat Spreader (Option)

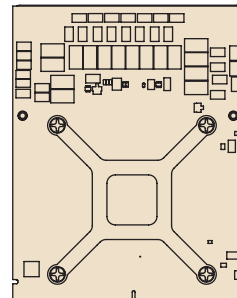
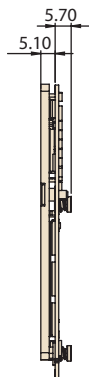
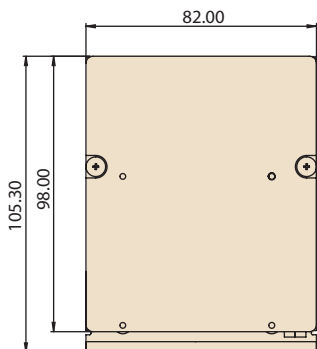

Block Diagram

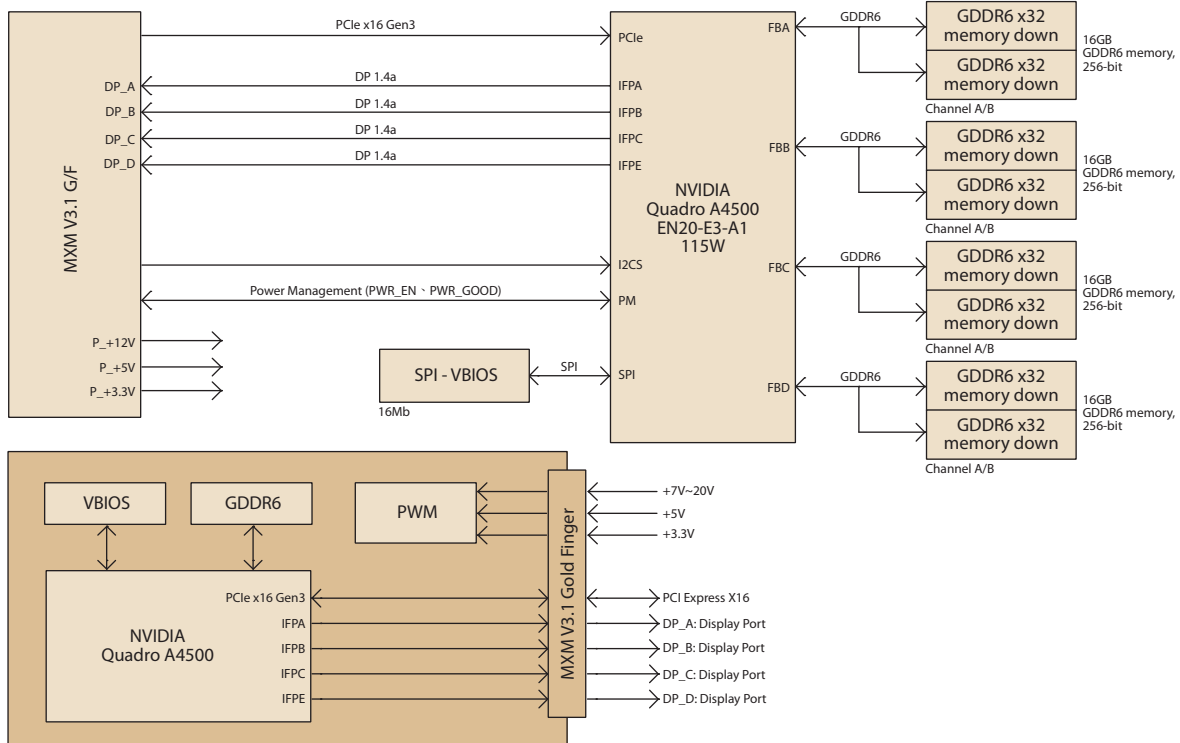

Ordering Information

Part Number	GPU Memory	GPU Base/Boost Clock	RT Cores	Tensor Cores	FP32 Performance	Max Power Consumption	Display Connectors	Supported Features
SKY-MXM-A4500-6SDA	16GB GDDR6	930 MHz / 1500 MHz	46	184	17.66 TFLOPS	115W	DP 1.4 * 4	Discrete Mode

Optional Accessories

Thermal Solution

Part Number	Description	Material	Dimension (mm)	Operating Temp Support
98R1X450010	Fan Cooler	Aluminum	110(L) x 102(W) x 36.6(H)	0 ~ 55°C
98R1X450000	Heat Spreader	Aluminum	98(L) x 82(W) x 4.9(H)	Depending on system thermal solution

MXM-Carrier

Part Number	Description	PCIe Interface	Dimension (mm)	Display Output
SKY-MXM-CARG4	MXM-Carrier PCIe to MXM PCIe Gen4	Gen4 x 16	235.95(L) x 162.2(H)	4 x DisplayPort 1.4a