

SOM-7567

Intel® Atom™/Celeron® Processor COM Express® Mini Module

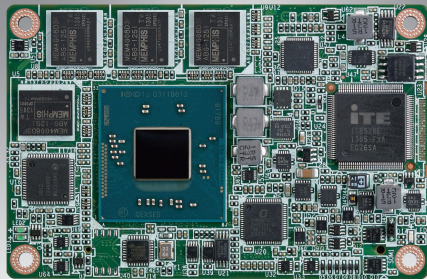

Features

- COM R.2.1 Type 10 Mini Module
- Intel® Atom™/Celeron® processor for Intelligent systems (Based on 22nm Silvermont microarchitecture)
- Onboard DDR3L and SSD
- 4.75 ~ 20 V wide-voltage input support
- Embedded Software APIs and Utilities supported

Software APIs:



Specifications

Form Factor	Form Factor	COM Express Mini Module				
	Pin-out Type	COM Express R2.1 Type 10				
Processor System	CPU	Intel Atom E3845	Intel Atom E3825	Intel Atom E3815	Intel Celeron J1900	Intel Celeron N2930
	Core	4	2	1	4	4
	Base Frequency (Normal)	1.91GHz	1.33GHz	1.46 GHz	2.00 GHz	1.83 GHz
	Base Frequency (Burst)	-	-	-	2.42 GHz	2.16 GHz
	LLC	2MB	1MB	512KB	2MB	2MB
	CPU TDP	10W	6W	5W	10W	7.5W
	BIOS	AMI UEFI 64Mbit				
Memory	Technology	DDR3L-1333	DDR3L-1066	DDR3L-1066	DDR3L-1333	DDR3L-1333
	ECC Support	N/A				
	Max. Capacity	Up to 4G				
SSD	Technology & Capacity	TLC up to 64GB				
Graphics	Controller	Intel® HD graphics (Gen 7 gfx)			No graphic	
	Frequency (Normal)	542 MHz	533 MHz	400 MHz	688 MHz	313 MHz
	Frequency (Turbo)	792 MHz	-	-	854 MHz	854 MHz
	3D/HW Acceleration	DX11, OGL3.2, OCL1.1, and H.264/AVC, VC-1, MPEG2 HW Decode/Encode				
Display	LCD	LVDS 1-ch 18/24-bit, up to 1366 x 768 resolution				
	DDI (HDMI/DVI/DisplayPort)	Up to 2560 x 1600 resolution				
	Dual Display	LCD + DDI				
Expansion	PCI Express x1	3 Ports (optional 4 PCIe x1 or 1 PCIe x4 while removing Ethernet), compliant to PCIe Gen2 5.0 GT/s				
	Audio Interface	Intel HD Audio				
	LPC	Yes				
Serial Bus	SMBus	Yes				
	I2C Bus	Yes				
Ethernet	Controller	Intel i210E				
	Speed	10/100/1000MHz				
I/O	SATA	1 Ports (optional 2 ports while remove onboard storage), compliant to SATA2.0 3.0 Gb/s				
	USB3.0	1 port				
	USB2.0	4 ports				
	SPI Bus	1 channel, for SPI BIOS EEPROM				
	GPIO	8-bit				
	Watchdog	0-65535 sec, multi-level, multi-option watchdog timer support by Advantech iManager				
	COM Port	2 ports 2-wire COM port (TX/RX)				
	Express Card	2 ports				
	Smart Fan	1 port				
	Power	Type	ATX/AT: 12Vin, VSB: 5VSB			
Supply Voltage		Vin: 4.75V - 20V VSB: 4.75V - 5.25V				
Power Consumption (Max.)		+12V @ 1.38A (E3845)				
		+12V @ 1.59A (J1900)				
		+12V @ 0.74A (E3815)				
Power Consumption (Idle)		+12V @ 0.84A (E3825)				
	+12V @ 1.44A (N2930)					
	+12V @ 0.67A (E3845)					
Environment	Temperature	Operating Standard: 0 ~ 60 °C (32 ~ 140 °F) Extend Temp.: -40 ~ 85 °C (-40 ~ 185 °F) Storage: -40 ~ 85 °C (-40 ~ 185 °F)				
	Humidity	Operating: 40 °C @ 95% relative humidity, non-condensing Storage: 60 °C @ 95% relative humidity, non-condensing				
Mechanical	Dimensions	84 x 55 mm (3.3" x 2.17")				

Block Diagram

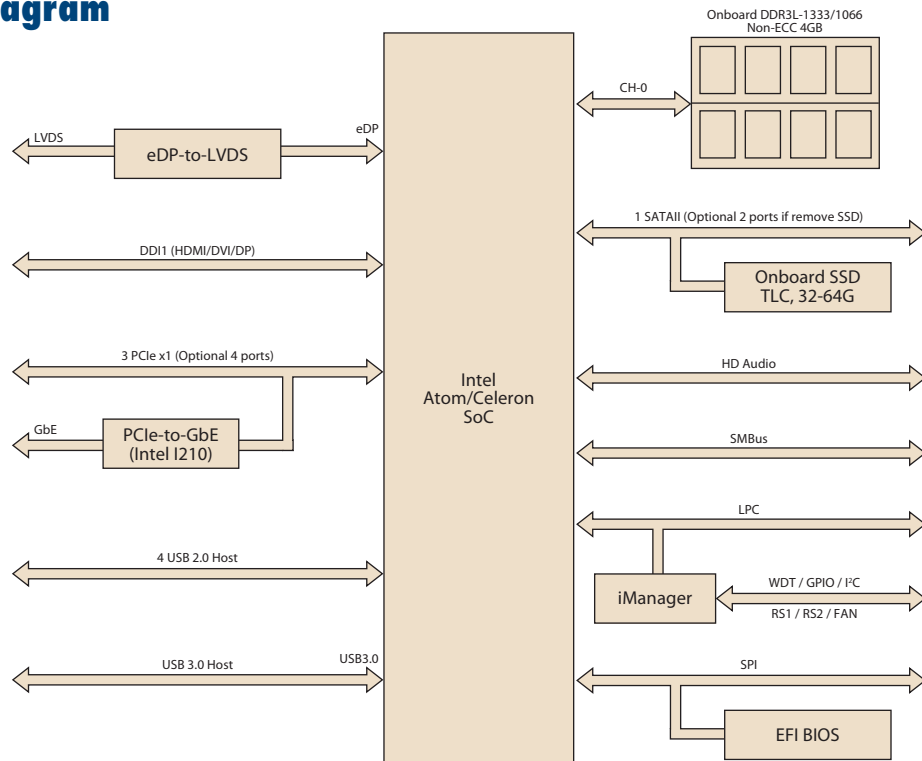

Ordering Information

Part No.	CPU	Onboard Memory	Onboard Flash	LVDS	HDMI/DVI/DP	PCIe x1	HD Audio	GbE	SATAII	USB 3.0	USB 2.0	Thermal Solution	Operating Temperature
SOM-7567CS0CB-S9A2	Atom E3845	4GB	TLC 64GB	18/24 bits	1	3	Yes	1	2	1	4	Passive	0 ~ 60 °C
SOM-7567BS0CB-S3A2	Atom E3825	2GB	N/A	18/24 bits	1	3	Yes	1	2	1	4	Passive	0 ~ 60 °C
SOM-7567BS0CB-S5A2	Atom E3815	2GB	N/A	18/24 bits	1	3	Yes	1	2	1	4	Passive	0 ~ 60 °C
SOM-7567CM8CB-U0A2	Celeron J1900	4GB	N/A	18/24 bits	1	3	Yes	1	2	1	4	Passive	0 ~ 60 °C
SOM-7567BS0CB-S8A2	Celeron N2930	4GB	TLC 64GB	18/24 bits	1	3	Yes	1	2	1	4	Passive	0 ~ 60 °C
SOM-7567CS0XB-S9A2	Atom E3845	4GB	TLC 64GB	18/24 bits	1	3	Yes	1	2	1	4	Passive	-40 ~ 85 °C
SOM-7567BS0XB-S5A2	Atom E3815	2GB	N/A	18/24 bits	1	3	Yes	1	2	1	4	Passive	-40 ~ 85 °C

*Any other sku or combination is project based support. Please contact sales for details.

Packing List

Part No.	Description	Quantity
-	SOM-7567 COM Express Mini Module	1
1960064246N021	Heatspreader	1

Optional Accessories

Part No.	Description
1960056280N001	Semi-Heatsink 84L x 55W x 13.2H mm (0 ~ 60° C)
1960050950N001	Semi-Heatsink 84L x 55W x 34H mm (-40 ~ 85° C)

Development Board

Part No.	Description
SOM-DB5800-U0A2E	Development Board for COM Express Mini Module Type 10 Pin-out

Embedded OS

OS	Part No.	Description
WES7	2070013084	WES7E SOM-7567 x64 V5.6.8 ENG