

WISE-710

ARM Cortex™-A9 Industrial Gateway with 2 x LAN, 3 x COM Ports, 4 x DI/DO

NEW

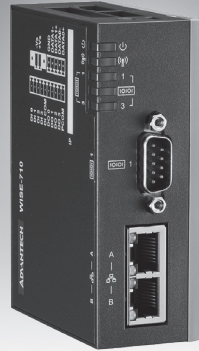

Features

- NXP® ARM® Cortex™-A9 i.MX6 processor
- 1 GB DDR3L RAM and 8 GB eMMC storage onboard
- 10/100/1000 Mbps Ethernet ports
- CANBus with programmable bit rate of up to 1 Mb/sec
- DIO wet contact & dry contact by switch support
- Isolated protection of digital input/output
- Optional mPCIe expansion slot for wireless modules
- Operating system Linux Ubuntu 16.04 (Default) and Yocto 2.1 support
- Wide operating temperature range (-20~55°C/-4~131°F)
- Advantech WISE-PaaS/Edgeline support with more than 200 I/O drivers

Introduction

The WISE-710 industrial IoT gateway is an open platform with Cortex A9 processor, equipped with 3 x serial ports, 2 x 10/100/1000 Ethernet ports, and 4 x DI/DO which is great solution to connect your legacy equipments to the new mesh networks. With its rich I/O, and wide operating temperature design, the gateway plays a role as PLC-side protocol converter, and also data logger for multiple industrial applications.

Specifications

General

- **Certification** CE, FCC
- **Mounting** Wall-Mount/ DIN-Rail
- **Power Consumption** 5W @ 24V_{DC}
- **Power Requirements** 24V_{DC} ± 20%, 0.5A
- **Dimension (W x H x D)** 115.58 x 73 x 36 mm (4.55 x 2.87 x 1.42 in)
- **OS Support** Linux Ubuntu 16.04 , 18.04 and Linux Yocto 2.1
- **Weight (Net)** 0.17 kg (0.375 lb)

System

- **CPU** NXP® ARM® Cortex™-A9 i.MX6 dual-core 1.0 GHz processor
- **Indicators** LEDs for Power, Wireless, LAN, Serial
- **Storage** 8GB eMMC
- **Working Memory** 1GB DDR3 RAM (Max. 2GB)
- **SD Slot** 1 x Micro-SD slot
- **Real-time Clock** Yes

Communication

- **Serial Port** COM1 1x RS232/485, DB9, 0.15~115.2kbps
COM2 1x RS485/CANBus (by switch), 2pin, 50~921.6kbps; CANBus, 20~1000k
COM3 1x RS485, 2pin, 0.15~115.2kbps
- **Ethernet Port** 2 x 10/100/1000 Base-T RJ-45 ports
- **USB Port** 1 x Micro USB Host (Support flash storage)
- **Isolated DI/DO** 4-ch digital input, 4-ch digital output, isolation protection voltage 2000 V_{DC}
- **Expansion slot** 1x Full size mPCIe with USB signal

Gateway Software

- **Application Software** WISE-PaaS/Edgeline
- **Number of IO Tag** 3000 Tags
- **Protocol Support** more than 200 drivers

Environment

- **Operating Temperature** -20 ~ 55 °C (-4 ~ 131 °F) with 0.7 m/s air flow
- **Storage Temperature** -40 ~ 75 °C (-40 ~ 167 °F)
- **Humidity** 10 ~ 95% RH @ 40 °C, non-condensing
- **Vibration During Operation** 2 Grms, IEC 60068-2-64, random, 5 ~ 500 Hz, 1 hr/axis.
- **Shock During Operation** 10G, IEC 60068-2-27, half sine, 11 ms duration

Ordering Information

- **WISE-710-N600C** Cortex™-A9 Processor, Linux Ubuntu 16.04, 1G RAM, 2 x LAN, 3 x COM, 4 x Di/DO, 1 x mPCIe

- **WISE-710-N600D** Cortex™-A9 Processor, Linux Ubuntu 18.04, 2G RAM, 2 x LAN, 3 x COM, 4 x Di/DO, 1 x mPCIe
- **ESRP-PCS-WISE710** WISE-710-N600C with Linux Yocto 2.1, EdgeLink

Expansion Kits

WISE-710-0010A

Analog Input

- **Channels** 4
- **Resolution** 16bits Bipolar; 15bits Unipolar
- **Sampling Rate** 10Hz (Total) with 50/60Hz Rejection
- **Accuracy** ±0.1% for Voltage Input; ±0.2% for Current Input
- **Input Range** 0~150mV, 0~500mV, 0~1V, 0~5V, 0~10V, ±150mV, ±500mV, ±1V, ±5V, ±10V, 0~20mA, ±20mA, 4~20mA
- **Input Impedance** >1MΩ (Voltage), 240 Ω (External resistor for current)
- **Support Data** Scaling and Averaging

Digital Input

- **Channels** 4 (Dry Contact)
- **Supports 200Hz Counter Input (32-bit + 1-bit overflow)**
- **Supports keep/discard counter value on power-off**
- **Support inverted digital input status**

WISE-710-0020A

Digital Input

- **Channels** 6 (Dry Contact)
- **Supports 3kHz Frequency Input**

Digital Output (Sink Type)

- **Channel** 2
- **Output Current** 100 mA, At 0 -> 1: 100 us, At 1 -> 0: 100 us (for Resistive Load)
- **Supports Pules Output 5 kHz**
- **Max. Load Voltage** 30V

Serial Port

- **Port Number** 1
- **Type** RS-485
- **Data Bits** 7, 8
- **Stop Bits** 1, 2
- **Parity** None, Odd, Even
- **Baud Rate (bps)** 1200, 2400, 4800, 9600, 19200, 38400, 57600, 115200
- **Protocol** Modbus/RTU (Total 32 addresses by 8 max. instructions)

Dimensions

Unit: mm

WISE-710-N600C

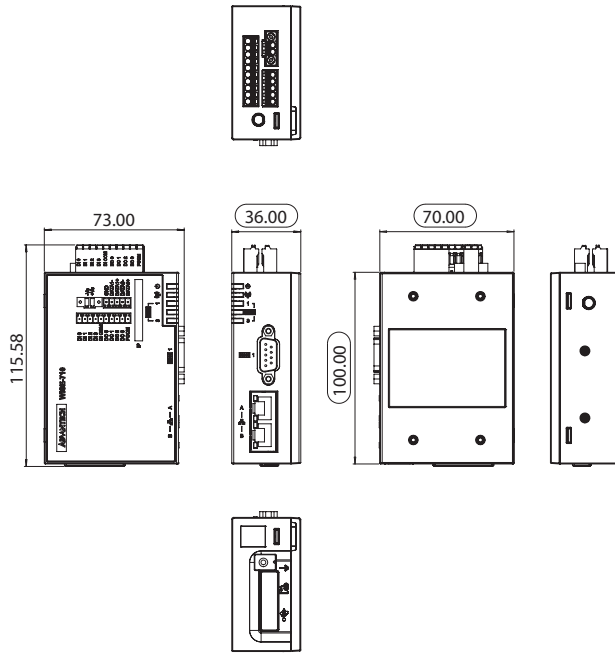

WISE-710-N600C + WISE-710-0010A

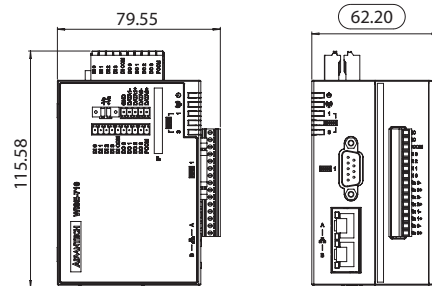

WISE-710-N600C + WISE-710-0020A

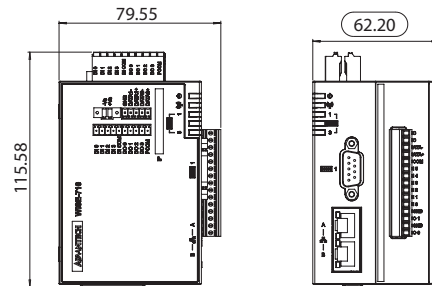

Optional Accessories

WiFi Solution

- 968AD00605 WiFi Module, 802.11 a/b/g/n (2.4&5GHz), BT5, 1T1R
- 9656EWMG00E Half-size to Full-size Mini PCIe Bracket Pack
- 1750009036-01 Cable Ant. SMA/F-R-BH MHF1/113 BLK L100mm
- 1750008717-01 Dipole Ant. D.B 2.4/5G WIFI 3dBi SMA/M-RBLK for 968AD00605
- 96PD-RYWDB002A 968AD00605 Wifi Module with TELEC antenna and SMA cable for Japan region
- EWM-W172H01E 802.11ac/a/b/g/n 2T2R Wi-fi + Bluetooth 4.2 Half, TELEC
- 1750008717-01 Dipole Ant. D.B 2.4/5G WIFI 3dBi SMA/M-R BLK for EWM-W172H01E, TELEC

LTE Solution

- 968AD00589 LTE Module, Global Band
- 1750009067-01 Dipole Ant. LTE 1.5/2dBi SMA/M BLK 144
- 1750009035-01 Cable Ant. SMA/F-BH MHF1/113 BLK L100mm

* Please contact regional distributor to purchase TELEC antenna locally.

Others

- 96FMMSDI-4G-ET-AT1 ATP 4G MICRO SD CARD I-GRD SLC(G)
- 96FMMSDI-8G-ET-AT1 ATP 8G MICRO SD CARD I-GRD SLC(G)

Power Supply

- 96PSD-A20W24-MM A/D 100-240V 20W 24V MDR DIN RAIL
- 1700029720-01 PSU power cord (USA), AC Conn., 3-pin, UL/CSA, 1.83M
- 1700030520-01 PSU power cord (CN), AC Conn., 3-pin, CCC, 1.5M
- 1700031408-01 PSU power cord (EU), AC Conn., 3-pin, 80CM (EU)

Power Adaptor

- XWISE-IPU15-108 110-220V AC Adaptor, US AC Plug
- XWISE-AUPLUG AU Type Plug for XWISE-IPU15-108
- XWISE-EUPLUG EU Type Plug for XWISE-IPU15-108
- XWISE-UKPLUG UK Type Plug for XWISE-IPU15-108

Front I/O View

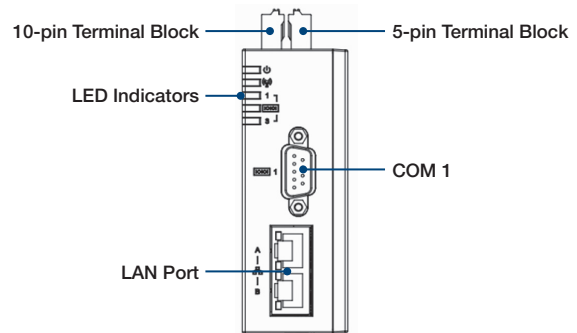

Top I/O View

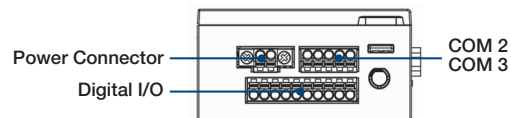

Underside I/O View

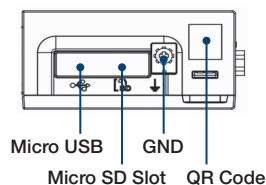

Please note: If some optional modules are offered with the system, additional system certificates may be required in certain regions/countries.
Please contact Advantech for certificate compliance.